

# BERMUDA RESIDENTIAL BUILDING CODE 2014

**OPERATIVE DATE**

The Minister in exercise of the powers conferred upon him by section 23A of the Building Act 1988 issues this code, the *Bermuda Residential Building Code 2014*. The code shall come into effect on Monday, 12 January 2015.

## PREFACE

This code is intended as a self contained reference document for all members of the building industry: owners, architects, engineers, estimators and contractors. It draws on regulations contained in various government legislation such as The Building Act 1988, The Building Code 1998 and the Public Health Act 1949 and consolidates the requirements, as they relate to residential dwellings, into one code of practice. In addition, some of the requirements of the Bermuda Residential Building Code 2014 are modified to fit what has become, over the years, 'traditional' practice in the Bermuda building environment. The code also attempts to take into account the standard uses of materials in Bermuda for residential dwellings.

This code is designed to be a specification based document as opposed to a performance standard code. The difference is that this code identifies specific materials and methods of construction that should be utilized in building activities. In contrast, a performance Code identifies the results to be achieved in construction. The result is that compliance with the various aspects of this code will satisfy the *Building Official* that the work is acceptable. Thus, if all aspects of a dwelling comply with the requirements of this code, no specific engineering design will be necessary. This does not preclude anyone from designing a building or parts of a building that are outside the scope of this code. It simply means that those aspects of the building will have to be designed by a suitably qualified person to comply with the referenced *Bermuda Commercial Building Code*.

Although a rational engineering approach has been adopted, advantage has been taken of the redundancies, additional strength and other favourable factors known to be present in traditional Bermuda buildings, even though such factors cannot normally be taken into account in specific engineering design.

Every effort has been made to limit the amount of references to other codes of practice and standards to a minimum, and to contain as much of the material in one document as possible. However, there is still a need in some instances to reference other codes such as the National Electrical Code, Mechanical Code, Plumbing Code, International Energy Conservation Code and Residential Building Code, ADA Design manual and Fair Housing Act where the incorporation of all the necessary requirements into this document would be impractical.

As with any code of practice, methods and materials will change over time, and, thus, it will be necessary to produce updates to the code on a periodic basis. It is hoped however to keep such amendments to a minimum.

In respect of increased awareness regarding residential developments, due consideration has been directed towards sustainability, hence, the need to embrace accessibility as a necessity for single and multiple dwelling units and site developments in general. In addition, the current initiative is to promote a policy of energy saving and renewable energy technology. Contained in this residential code are mandatory requirements as well as an **advisory** 'appendix' which provide a comprehensive guide to minimizing Bermuda's energy consumption within the residential development arena.

*Nothing in this code shall infer compliance with any planning regulations. Planning permission in accordance with the current Development and Planning Act must be obtained prior to any building permit being issued.*

## About the Production of the Bermuda Residential Building Code 2014

The Bermuda Residential Building Code was produced by the Department of Planning, Bermuda in collaboration with representatives from other Government Departments and members of the Bermuda construction industry. The review of the first draft of the code was conducted 'in-house' by the Building Inspectors. Emphasis was placed on ensuring that 'traditional' practices that have existed in Bermuda for many years were promoted where appropriate. A Building Code Committee formed with representatives from the various local associations and government departments to carry out a review of the second draft of the code. The committee met a number of times to produce the document.

### CODE REVIEW COMMITTEES

#### Building Control Division, Department of Planning, Government of Bermuda

Gordon Ness	Building Control Officer
Yolanda Bashir-Paige	Former Compliance Officer
Leroy Rodgers	Senior Building Inspector
Omar Douglas	Plans Examiner
George Morton	Former Building Inspector
Kenneth Young	Building Inspector
Damon Walker	Building Inspector
Melvin Holdipp	Building Inspector
Dal Jones	Elevator Inspector
Steven Every	Electrical Inspector
Alan Smith	Former Electrical Inspector
Tania Tavares	Enforcement Officer
Andrea Crockwell	Former Permits Processor
Amanda Smith	Former Administrative clerk
Danielle Simmons	Former Administrative clerk

#### Building Code Committee

Yolanda Bashir-Paige	Committee Chairperson
Gordon Ness	Committee Member
Leroy Rodgers	Committee Member
Sue Bendell	Bendell Design
Germano Botelho	Botelho Wood Architects
Martin Biffin	Ministry of Public Works, Electrical/Mechanical Section
Colin Campbell	OBM Ltd.
David Cox	OBM Ltd.
Richard Crossley	Works and Engineering
Nigel Daley	Spectrum Consulting Services Ltd.
Andrew Davis	Solar Bermuda Ltd.
Peter Drew	The Department of Conservation Services
Quinnell Francis	Professional Surveyors Registration Council
Lynniece Nisbett-Garnett	Department of Sustainable Development

Doris Goodman (Recording Secretary)	Reporting and Transcription Services (Bermuda) Ltd.
Simon Hodgson	S.H.Y Architecture
Andrew Kennedy	Department of Health
Ari Ming	Ministry of Finance Office of Project Management & Procurement
George Morton	Former Building Inspector and former Chairman of the Historic Buildings Advisory Committee
Mike Murphy	Bermuda Electric Light Company
Bruce Perinchief	Entech
Ed Pereira	Pereira Engineering Ltd.
Sarah Vallis Pietila	Sarah Vallis Pietila
Lori Polukoshko	Ministry of Public Works, Electrical/Mechanical Section
Charlita Saltus	Conyers & Associates Ltd.
Alan Smith	Former Electrical Inspector
Jamie Smith	Solar Bermuda Ltd.
Josonne Smith	Bermuda Fire Service
Gary Simmons	Linberg and Simmons Ltd.
Keith Simmons	National Office for Seniors and Physically Challenged
George Simons	Department of Health
Charles Tatem	Design Associates Ltd.
Glyn Quarterly	Terceira Quarterly Associates Architects
Steve Wagner	Linberg and Simmons Ltd.

#### Additional Contributors

Richard Lowry	Heritage Officer
Harry Masters	Cabinet Office Intern
Aidan Stones	Onsite Engineering
Michael Tucker	Onsite Engineering
Jeane Nikolai	Department of Energy
Aran McKittrick	Department of Energy
Chris Worboys	Bermuda Engineering



## TABLE OF CONTENTS

TABLE OF CONTENTS.....	5
LIST OF ILLUSTRATIONS.....	15
LIST OF TABLES.....	19
1 SCOPE AND INTERPRETATION.....	21
1.1 SCOPE.....	21
1.2 INTERPRETATION.....	21
1.3 LIMITATIONS.....	21
1.4 NOT COVERED IN CODE.....	21
1.5 VARIANCES TO THE CODE FOR LISTED BUILDINGS.....	22
1.6 EXEMPTION.....	22
1.7 USING THE TABLES.....	22
1.8 DESIGN PARAMETERS.....	22
2 ADMINISTRATION.....	25
2.1 BUILDING PERMIT REQUIRED.....	25
2.2 BUILDING PERMIT NOT REQUIRED.....	25
2.3 EXISTING STRUCTURES.....	26
2.4 APPLICATION FOR PERMIT.....	26
2.5 CONSTRUCTION DOCUMENTS.....	26
2.6 PERMITS.....	26
2.7 INSPECTIONS.....	28
2.8 FIELD CORRECTION NOTICES.....	29
2.9 STOP WORK NOTICES.....	29
2.10 DIRECTIONS.....	30
2.11 CERTIFICATE OF COMPLETION AND OCCUPANCY.....	30
2.12 SUPPLY OF CURRENT.....	31
2.13 OFFENCES.....	31
2.14 PLANNING APPROVAL MUST BE IN FORCE.....	32
3 DEFINITIONS, ABBREVIATIONS, SYMBOLS & CONVERSIONS.....	33
3.1 SCOPE.....	33
3.2 INTERCHANGEABILITY.....	33
3.3 TERMS NOT DEFINED.....	33
3.4 DEFINITIONS.....	33
3.5 ABBREVIATIONS AND SYMBOLS.....	43
3.6 CONVERSION FACTORS.....	44
4 BUILDING LAYOUT.....	45
4.1 GENERAL.....	45
4.2 ROOM SIZES.....	45
4.3 CEILING HEIGHTS.....	45
4.4 STAIRWAYS.....	46
4.5 HANDRAILS.....	49
4.6 GUARDRAILS.....	51

4.7	EXITS.....	53
4.8	DOORS.....	56
4.9	SANITATION .....	56
4.10	LIGHTING .....	57
4.11	VENTILATION .....	59
4.12	SOUND TRANSMISSION CONTROL .....	60
4.13	RAMPS.....	60
5	<i>SITWORKS</i> .....	61
5.1	PROPOSED AND EXISTING WORKS.....	61
5.2	EXISTING SERVICES .....	61
5.3	SITE BOUNDARY .....	61
5.4	SETTING OUT .....	61
5.5	EXISTING ROCKCUTS/RETAINING WALLS .....	61
5.6	NEW EXCAVATIONS/ROCKCUTS/RETAINING WALLS.....	62
5.7	FILL .....	63
5.8	SITE GRADING.....	64
5.9	RETAINING WALLS .....	64
5.10	BIOENGINEERED WALLS AND EMBANKMENTS .....	70
5.11	CERTIFICATE OF INSTALLATION.....	71
5.12	FREE STANDING WALLS .....	71
5.13	DEMOLITION .....	72
5.14	SITE DRAINAGE.....	73
5.15	CAVES.....	76
6	<i>FOUNDATIONS</i> .....	77
6.1	SCOPE .....	77
6.2	SITE INVESTIGATION .....	77
6.3	SUITABLE FOUNDATION MATERIALS .....	77
6.4	UNSUITABLE FOUNDATION MATERIALS .....	77
6.5	CONCRETE FOOTINGS .....	77
7	<i>FOUNDATION WALLS</i> .....	81
7.1	GENERAL .....	81
7.2	UNBALANCED FILL .....	81
7.3	DAMPPROOFING MATERIAL .....	81
7.4	SUBSOIL DRAINAGE .....	81
7.5	BACKFILL.....	81
8	<i>FLOORS</i> .....	85
8.1	GENERAL .....	85
8.2	CONCRETE GROUND FLOORS ON GRADE .....	85
8.3	SUSPENDED CONCRETE FLOORS .....	86
8.4	TIMBER FLOORS.....	91
8.5	FLOOR FINISH .....	100



9	MASONRY WALLS .....	101
9.1	GENERAL .....	101
9.2	CONSTRUCTION .....	101
9.3	LATERAL SUPPORT .....	101
9.4	BOND BEAMS .....	109
9.5	OPENINGS IN WALLS.....	109
9.6	CHASES AND RECESSES .....	110
9.7	LINTELS.....	110
10	ROOFS .....	121
10.1	GENERAL .....	121
10.2	PITCHED ROOFS .....	121
10.3	JOINTS IN ROOF FRAMING MEMBERS .....	122
10.4	BEARING.....	122
10.5	TIMBER WALL PLATES.....	122
10.6	ANCHOR BOLTS .....	122
10.7	OVERHANGS.....	122
10.8	FALSE RAFTER FEET .....	123
10.9	HURRICANE CLIPS .....	123
10.10	ROOF VENTILATION .....	124
10.11	BERMUDA SLATE ROOF CONSTRUCTION .....	124
10.12	LIGHTWEIGHT ROOF CONSTRUCTION .....	125
10.13	COATING .....	125
10.14	INSULATION.....	125
10.15	ROOF REPLACEMENT FOR LISTED BUILDINGS .....	125
10.16	CHIMNEYS & FIREPLACES.....	135
10.17	FOUNDATIONS .....	135
10.18	FIRE WALL CONSTRUCTION .....	135
10.19	FIREPLACES .....	135
10.20	HEARTH .....	135
10.21	CLEARANCE TO COMBUSTIBLES .....	136
10.22	STEEL FIREPLACE UNITS .....	136
10.23	LINTEL.....	136
10.24	CHIMNEY SIZES .....	136
10.25	CHIMNEY WALLS.....	136
10.26	CHIMNEY LINING .....	137
10.27	CHIMNEY HEIGHT & LOCATION.....	138
10.28	WEATHER PROOFING OF CHIMNEYS.....	138
10.29	HEIGHT OF CHIMNEYS .....	138
10.30	FACTORY BUILT FIREPLACE UNITS.....	138
10.31	COMBUSTION AIR TO FURNACES.....	139
11	EXTERIOR WALLS.....	141
11.1	GENERAL .....	141
11.2	PLASTER.....	141
11.3	ALTERNATIVE COATINGS .....	141
11.4	WINDOWS AND DOORS.....	141

12	CONCRETE .....	143
12.1	GENERAL .....	143
12.2	CONCRETE QUALITY .....	143
12.3	PREPARATION OF EQUIPMENT & PLACE OF DEPOSIT .....	144
12.4	MIXING .....	145
12.5	PLACING CONCRETE .....	145
12.6	CONSTRUCTION JOINTS .....	145
12.7	FORMWORK .....	145
12.8	PLACEMENT OF REINFORCING .....	146
13	MASONRY CONSTRUCTION .....	149
13.1	GENERAL .....	149
13.2	MASONRY UNITS .....	149
13.3	NATURAL STONE .....	149
13.4	MORTAR .....	149
13.5	PLASTER .....	149
13.6	LAYING BLOCKS .....	150
13.7	CONCRETE FILLED MASONRY .....	150
13.8	REINFORCED MASONRY .....	151
14	TIMBER .....	153
14.1	TIMBER PROPERTIES .....	153
14.2	TREATMENT .....	153
14.3	MOISTURE CONTENT .....	153
14.4	IDENTIFICATION .....	153
14.5	CONNECTIONS .....	153
14.6	NOTCHES .....	154
14.7	HOLES .....	154
14.8	SUPPORTS .....	154
14.9	PLACEMENT OF BOLTS .....	154
14.10	TIMBER COLUMNS .....	155
14.11	STORAGE AND HANDLING .....	155
15	STEEL .....	157
15.1	GENERAL .....	157
15.2	STRUCTURAL STEEL .....	157
15.3	CONNECTIONS .....	157
16	GLAZING .....	159
16.1	LABELING .....	159
16.2	DESIGN .....	159
16.3	SAFETY GLAZING .....	159

17	<i>SWIMMING POOLS, SPAS AND HOT TUBS</i> .....	161
17.1	LOCATIONS .....	161
17.2	STRUCTURAL DESIGN .....	161
17.3	WALL SLOPES .....	161
17.4	FLOOR SLOPES .....	161
17.5	STEPS AND LADDERS .....	161
17.6	WATER SUPPLY .....	161
17.7	WATER TREATMENT .....	162
17.8	DRAINAGE SYSTEMS .....	162
17.9	EQUIPMENT INSTALLATION .....	162
17.10	BARRIER/ENCLOSURE REQUIREMENTS .....	162
17.11	VENTILATION OF INDOOR SWIMMING POOLS, SPAS AND HOT TUBS .....	169
17.12	ELECTRICAL REQUIREMENTS .....	169
17.13	LOCATION OF POOLS RELATIVE TO OVERHEAD WIRING .....	170
18	<i>FIRE PROTECTION</i> .....	171
18.1	EMERGENCY ESCAPES .....	171
18.2	SMOKE ALARMS .....	171
18.3	MINIMUM SIGNALING INTENSITY .....	172
18.4	POWER SOURCE .....	172
18.5	DWELLING UNIT SEPARATIONS .....	173
18.6	FLOOR ASSEMBLIES .....	174
18.7	PARTY WALLS/FIRE WALLS .....	174
18.8	PENETRATIONS .....	178
18.9	GARAGES .....	178
18.10	INTERIOR FINISH .....	178
18.11	FIRE EXTINGUISHERS .....	178
18.12	ACCESS FOR FIRE VEHICLES .....	178
19	<i>MECHANICAL VENTILATION</i> .....	181
19.1	GENERAL .....	181
19.2	MECHANICAL VENTILATION .....	181
19.3	INTAKE OPENINGS .....	181
19.4	EXHAUST OPENINGS .....	181
19.5	OUTSIDE OPENING PROTECTION .....	182
19.6	CLOTHES DRYER EXHAUST .....	182
19.7	KITCHEN COOKING APPLIANCES .....	182
19.8	AIR CONDITIONERS .....	182
20	<i>ELECTRICAL</i> .....	183
20.1	DEFINITIONS .....	183
20.2	SWIMMING POOLS, HOT TUBS, AND SIMILAR INSTALLATIONS: ELECTRICAL DEFINITIONS .....	190
20.3	GENERAL .....	192
20.4	PERMITS, INSPECTIONS & APPROVALS .....	192
20.5	DEFECTIVE WIRING .....	192
20.6	LISTING AND LABELING .....	192
20.7	MECHANICAL EXECUTION OF WORK .....	192

20.8	CONCRETE ENCASED ELECTRODE .....	192
20.9	RECEPTACLE OUTLETS .....	193
20.10	SUMMARY OF RECEPTACLE OUTLET LOCATIONS .....	202
20.11	ELECTRIC WATER HEATERS .....	203
20.12	LIGHTING OUTLETS .....	204
20.13	ARC- FAULT CIRCUIT- INTERRUPTER PROTECTION .....	204
20.14	GFCI RECEPTACLES .....	204
20.15	FIXTURE LOCATIONS .....	208
20.16	LUMINAIRES IN CLOTHES CLOSETS.....	209
20.17	SWITCHES .....	211
20.18	PANELBOARDS AND CIRCUIT BREAKERS .....	211
20.19	OUTDOOR ELECTRICAL EQUIPMENT .....	217
20.20	SEPARATE DWELLINGS.....	217
20.21	APPLIANCES IN GARAGES .....	217
20.22	SWIMMING POOLS .....	217
20.23	BONDING.....	220
20.24	SPAS AND HOT TUBS .....	222
20.25	HYDROMASSAGE BATHTUBS .....	225
20.26	UNDERGROUND INSTALLATION OF WIRING .....	225
20.27	TEMPORARY WIRING.....	226
20.28	NEUTRAL CONDUCTOR IDENTIFICATION.....	226
20.29	WIRING METHODS PERMITTED .....	227
21	<i>LPG EQUIPMENT &amp; APPLIANCES .....</i>	<i>229</i>
21.1	GENERAL .....	229
21.2	PERMITS, INSPECTIONS & APPROVALS .....	229
21.3	CERTIFICATE OF INSTALLATION.....	229
21.4	MAXIMUM DESIGN PRESSURE.....	229
21.5	UNDERGROUND GAS PIPING .....	229
21.6	PIPING THROUGH WALLS .....	229
21.7	INSIDE BUILDING GAS PIPING .....	229
21.8	IDENTIFICATION .....	230
21.9	CONCRETE SLAB.....	230
21.10	PROHIBITED LOCATIONS.....	230
21.11	PIPING MATERIALS .....	230
21.12	ELECTRICAL GROUNDING.....	230
21.13	SHUT OFF VALVE.....	230
21.14	TESTING .....	230
21.15	CONTAINERS.....	231
21.16	GAS FIRED WATER HEATERS .....	231
22	<i>PLUMBING DEFINITIONS .....</i>	<i>233</i>
23	<i>PLUMBING.....</i>	<i>237</i>
23.1	GENERAL .....	237
23.2	PERMITS, INSPECTIONS & APPROVALS .....	237
23.3	INSPECTIONS & TESTS.....	237
23.4	WATER SUPPLY PIPE AND FIXTURE PURGING .....	237
23.5	GENERAL REQUIREMENTS .....	238
23.6	PIPING SUPPORT .....	238
23.7	IDENTIFICATION OF MATERIALS .....	239

23.8	NOMINAL PIPE SIZES .....	239
23.9	WORKMANSHIP.....	240
24	DRAINAGE.....	241
24.1	GENERAL .....	241
24.2	CONNECTION TO SANITARY DRAINAGE SYSTEM.....	241
24.3	GRAVITY FLOW .....	241
24.4	DISCHARGE OF RAINWATER .....	241
24.5	DRAINAGE PIPES ABOVE WATER TANKS OR POTABLE WATER COLLECTION AREAS .....	241
24.6	OUTDOOR SHOWER DRAINS.....	242
24.7	PROHIBITED LOCATION OF STORM AND TANK WATER PIPE OUTLETS .....	242
24.8	SANITARY DRAINAGE.....	242
24.9	DRAINAGE PIPE CLEANOUTS.....	243
24.10	SLOPE OF HORIZONTAL DRAINAGE PIPES .....	244
24.11	UNDERGROUND SEWER AND DRAIN PIPES.....	244
24.12	ABOVE GROUND DRAINAGE .....	246
24.13	DRAINAGE, WASTE, VENT (DWV) HORIZONTAL PIPES AND BRANCHES .....	246
24.14	DRAINAGE FITTINGS & CONNECTIONS.....	247
24.15	PROHIBITED CONNECTIONS.....	247
24.16	DEAD ENDS.....	248
24.17	CHANGE IN SIZE .....	248
24.18	SUMPS AND EJECTORS.....	248
24.19	BUILDING DRAINS BELOW SEWER .....	248
24.20	FIXTURE TRAPS .....	248
25	VENTS.....	251
25.1	TRAP SEAL PREVENTION .....	251
25.2	VENTING REQUIRED .....	251
25.3	LIMITATIONS .....	251
25.4	TERMINATION .....	251
25.5	LOCATION OF VENT TERMINAL.....	251
25.6	VENT CONNECTIONS AND GRADES.....	251
25.7	GRADE .....	251
25.8	VENT CONNECTION TO DRAINAGE SYSTEM .....	251
25.9	VERTICAL RISE OF VENT .....	252
25.10	FIXTURE VENTS.....	252
25.11	TYPES OF VENTING METHODS .....	252
25.12	VENT PIPE SIZING.....	256
25.13	AIR ADMITTANCE VALVES.....	257
25.14	VENT REQUIRED .....	257
25.15	GRAY WATER RECYCLING SYSTEMS .....	257
26	CESSPITS.....	259
26.1	GENERAL .....	259
26.2	PERMITS AND INSPECTIONS .....	259
26.3	DRAINAGE INTO CESSPITS .....	259
26.4	SIZE.....	259
26.5	LOCATION.....	259

26.6	CESSPIT TOP SLABS .....	261
26.7	ACCESS .....	261
26.8	CESSPIT WALLS .....	261
26.9	SEPTIC TANK WITH BOREHOLE OR SAND FILTER .....	261
26.10	BACKFILLING BEHIND PITS .....	261
26.11	PRECAST CONCRETE PITS .....	262
27	WATER SUPPLY & DISTRIBUTION.....	263
27.1	GENERAL .....	263
27.2	WELLS.....	263
27.3	CROSS CONNECTIONS.....	263
27.4	CONNECTIONS TO POTABLE MAINS WATER SUPPLIES .....	263
27.5	SOLAR WATER HEATING SYSTEMS .....	263
27.6	HOT WATER REQUIRED.....	263
27.7	MINIMUM SIZE OF WATER SERVICE PIPE .....	263
27.8	PRESSURE .....	264
27.9	FIXTURE WATER SUPPLY PIPES .....	264
27.10	MAXIMUM FLOW .....	264
27.11	VALVES .....	264
27.12	TRENCHING .....	265
27.13	APPROVED WATER SERVICE AND DISTRIBUTION PIPE MATERIALS .....	265
27.14	SOLVENT CEMENT PRIMER .....	265
27.15	TESTING.....	265
27.16	FLUSHING AND DISINFECTION OF THE POTABLE WATER SYSTEM .....	265
27.17	WATER HEATERS .....	265
28	WATER TANKS .....	269
28.1	GENERAL .....	269
28.2	CATCHMENT .....	269
28.3	MINIMUM DEPTH.....	269
28.4	HEIGHT ABOVE GROUND WATER .....	269
28.5	STORAGE CAPACITY.....	269
28.6	DRAINAGE PIPES ABOVE WATER TANKS OR POTABLE WATER COLLECTION AREAS .....	269
28.7	ACCESS .....	270
28.8	VENTILATION.....	270
28.9	OVERFLOW .....	270
28.10	SEPARATION OF POTABLE WATER TANKS.....	270
28.11	SEPARATE TANKS REQUIRED .....	270
28.12	APARTMENT HOUSE DEVELOPMENTS .....	270
28.13	METAL DECKS PROHIBITED OVER TANKS .....	270
28.14	CONSTRUCTION OF WATER TANKS.....	270
28.15	SAFETY OF WATER TANK EXCAVATIONS .....	272
28.16	PREVENTION OF STANDING WATER .....	272
28.17	NON CONCRETE WATER TANKS .....	272
29	RAINWATER DRAINAGE.....	273
29.1	GENERAL .....	273
29.2	STRAINERS.....	273

29.3	SIZE OF RAINWATER PIPES.....	273
29.4	VERTICAL WALLS.....	273
29.5	DRAINAGE .....	273
29.6	EQUIPMENT ON ROOF.....	274
29.7	EXHAUSTS.....	274
30	<i>PLUMBING FIXTURES.....</i>	<i>275</i>
30.1	GENERAL .....	275
30.2	INSTALLATION .....	275
30.3	WATER CLOSETS, URINALS, LAVATORIES AND BIDETS .....	275
30.4	SHOWER RECEPTORS .....	275
30.5	HOT WATER SUPPLY .....	276
30.6	PROTECTION OF POTABLE WATER SUPPLY .....	276
31	<i>ENERGY EFFICIENCY .....</i>	<i>277</i>
31.1	SCOPE AND ADMINISTRATION .....	277
31.2	DEFINITIONS.....	278
31.3	GENERAL REQUIREMENTS .....	282
31.4	BUILDING THERMAL ENVELOPE .....	282
31.5	SYSTEMS.....	282
31.6	ELECTRICAL POWER AND LIGHTING SYSTEMS.....	285
32	<i>ACCESSIBILITY GUIDELINES .....</i>	<i>287</i>
32.1	DEFINITIONS.....	287
32.2	PURPOSE .....	289
32.3	Safe Harbors and Points of Reference.....	289
32.4	Part 1 - MULTI-DWELLINGS.....	291
32.5	The New Rule for Multi-Dwelling Units.....	291
	DEFINITIONS TO INTERPRET TABLES .....	292
32.6	THE SEVEN REQUIREMENTS FOR MULTI-DWELLINGS (PART1) .....	296
32.7	ACCESSIBLE ROUTES .....	297
32.8	ACCESSIBLE AND USABLE PUBLIC AND COMMON USE AREAS .....	303
32.9	ACCESSIBLE ROUTE INTO AND THROUGH THE COVERED UNIT.....	310
32.10	LIGHT SWITCHES, ELECTRICAL OUTLETS, THERMOSTATS, AND OTHER ENVIRONMENTAL CONTROLS IN ACCESSIBLE LOCATIONS.....	312
32.11	REINFORCED WALLS FOR GRAB BARS .....	313
32.12	USABLE KITCHENS AND BATHROOMS.....	314
33	<i>PRECAUTIONS DURING BUILDING OPERATIONS .....</i>	<i>323</i>
33.1	PROTECTION OF SITE .....	323
33.2	ADJOINING PROPERTIES .....	323
33.3	STORAGE OF MATERIALS .....	323
33.4	DUST AND MATERIAL CONTROL .....	323
33.5	RUNOFF .....	323
33.6	SAFETY OF WATER TANK EXCAVATIONS .....	323
33.7	PREVENTION OF STANDING WATER .....	323
33.8	BUILDING WORKS ON ESTATE ROADS .....	324

33.9	<b>BUILDING WORKS ON PUBLIC ROADS</b> .....	324
33.10	<b>HEALTH &amp; SAFETY</b> .....	324
34	<i>APPENDIX A: CONSTRUCTION DOCUMENTS FOR BUILDING PERMIT SUBMISSION</i> .....	325
35	<i>APPENDIX B: NAIL FASTENING SCHEDULE</i> .....	331
36	<i>APPENDIX C: REFERENCED DOCUMENTS</i> .....	335
37	<i>APPENDIX D: PART 2 ACCESSIBILITY – ADVISORY GUIDANCE FOR SINGLE DWELLINGS</i> .	337
37.1	<b>THE STRUCTURE OF PART TWO</b> .....	337
37.2	<b>BUILDING BLOCKS</b> .....	338
37.3	<b>ACCESSIBLE ROUTES</b> .....	342
37.4	<b>GENERAL SITE &amp; BUILDING ELEMENTS</b> .....	352
37.5	<b>PLUMBING ELEMENTS &amp; FACILITIES</b> .....	359
37.6	<b>SPECIAL ROOMS AND SPACES</b> .....	383
37.7	<b>OTHER RECOMMENDATIONSTO MAKE A RESIDENCE ACCESSIBLE (NOT MANDATORY)</b> .....	387
38	<i>APPENDIX E: ENERGY AND WATER CONSERVATION ADVISORY DOCUMENT</i> .....	391
E.1	<b>The Purpose of the Energy and Water Conservation Advisory Document</b> .....	391
E.2	<b>Climate Zone</b> .....	391
E.3	<b>Energy Efficient Windows and Doors</b> .....	392
E.4	<b>Sun Tube Lights - Solar Pipe Lights</b> .....	393
E.5	<b>Passive Energy Design</b> .....	396
E.6	<b>Ventilation</b> .....	398
E.7	<b>Solar Photovoltaic</b> .....	402
E.8	<b>Solar Water Heaters</b> .....	405
E.9	<b>Sustainable drainage systems or Pervious Surfaces</b> .....	407
39	<i>APPENDIX F: CONTACT INFORMATION FOR GOVERNMENT DEPARTMENTS</i> .....	415
40	<i>REFERENCES</i> .....	417



## LIST OF ILLUSTRATIONS

Figure 1-1 - Building Limitations.....	23
Figure 4-1 - Ceiling Heights.....	45
Figure 4-2 - Stairway Headroom Requirements.....	46
Figure 4-3 - Allowable Stairway Dimensions.....	47
Figure 4-4 - Winder Stairs.....	48
Figure 4-5 - Circular Stairs.....	48
Figure 4-6 - Spiral Stairs.....	49
Figure 4-7 - Design criteria for window well (a).....	54
Figure 4-8 - Design criteria for window well / rough opening (b).....	55
Figure 5-1 - Existing Rockcuts and Retaining Walls.....	62
Figure 5-2 - Proposed New Rockcuts and Retaining Walls.....	63
Figure 5-3 - Placement of Fill.....	64
Figure 5-4 - Retaining Wall Type 1.....	68
Figure 5-5 - Retaining Wall Type 2.....	69
Figure 5-6 - Retaining Wall Type 3.....	70
Figure 5-7 - Free Standing Wall Construction.....	71
Figure 5-8 - Drainage Soakaway Pits.....	75
Figure 6-1 - Typical Concrete Foundation.....	78
Figure 6-2 - Shallow Footings.....	79
Figure 7-1 - Foundation Wall Construction.....	83
Figure 0-2 - Foundation Wall Construction.....	83
Figure 8-1 - Support to Walls above Suspended Slabs.....	87
Figure 8-2 - Bearing of Suspended Slabs onto Walls.....	87
Figure 8-3 - Placing Conduit in Concrete Slabs.....	88
Figure 8-4 - Cantilevered Concrete Slabs.....	91
Figure 8-5 - Lateral Support to Floor Joists.....	93
Figure 8-6 - Supports to Timber Floor Joists.....	95
Figure 8-7 - Cantilevered Floor Joists.....	97
Figure 8-8 - Openings in Floor Joists.....	98
Figure 8-9 - Notches in Floor Joists.....	99
Figure 8-10 - Holes in Floor Joists.....	99
Figure 9-1 - Acceptable Means of Providing Horizontal Supports to Masonry Walls.....	105
Figure 9-2 - Alternative Methods of Providing Horizontal Supports to Masonry Walls.....	106
Figure 9-3 - Minimum length of Lateral Support Walls.....	107
Figure 9-4 - Connection to Existing Walls.....	107
Figure 9-5 - Connection of Intersecting Walls.....	108
Figure 9-6 - Bond Beams.....	109
Figure 9-7 - Lintels.....	111
Figure 9-8 - Contributory Roof and Floor Spans to Lintels.....	112
Figure 10-1 - Typical Roof Construction Details.....	126
Figure 10-2 - Optional Collar Tie Locations.....	127
Figure 10-3 - Typical fireplace and Chimney construction details.....	137
Figure 10-4 - Fireplace Hearth Dimensions.....	138
Figure 10-5 - Maximum Chimney Height.....	139
Figure 17-1 - Fence height.....	165
Figure 17-2 - Vertical spacing (a).....	165
Figure 17-3 - Vertical spacing (b).....	165
Figure 17-4 - Chain link fence.....	166

Figure 17-5 - Lattice fence diagram .....	166
Figure 17-6 - Pool gate.....	167
Figure 17-7 - Door alarm.....	168
Figure 17-8 - Swimming Pool Required Dimensions.....	169
Figure 18-1 - Smoke alarm locations.....	173
Figure 18-2 - Fire separation between dwelling units that are under one ownership.....	175
Figure 18-3 - Fire separation between dwelling units that are separately owned .....	176
Figure 18-4 - Firestopping requirements for shared party wall.....	177
Figure 20-1 - A concrete-encased electrode.....	193
Figure 20-2 - Examples of tamper –resistant receptacles.....	193
Figure 20-3 - Tamper Resistant Fact Sheet.....	194
Figure 20-4 - Dimensions shown are maximum spacing of general purpose receptacle.....	195
Figure 20-5 - Wall space of 24” or greater must have a receptacle .....	195
Figure 20-6 - Countertop Receptacle outlet locations .....	196
Figure 20-7 - Countertop Receptacle outlet locations .....	197
Figure 20-8 - Receptacle outlet locations.....	197
Figure 20-9 - Receptacle outlet locations.....	198
Figure 20-10 - Receptacle outlet locations.....	198
Figure 20-11 - Island / Peninsular Countertop Receptacle .....	199
Figure 20-12 - Hallway receptacles.....	200
Figure 20-13 - Outdoor receptacles.....	201
Figure 20-14 - A typical water heater branch-circuit installation.....	203
Figure 20-15 Receptacles in Damp or Wet locations or Shower Space.....	205
Figure 20-16 - Kitchen GFCI receptacles outlets locations .....	206
Figure 20-17 - Wet bar, bar sink, laundry area - GFCI receptacle outlet locations.....	206
Figure 20-18 - Hydromassage bathtub receptacle accessibility .....	207
Figure 20-19 - Luminaires in bathtub and shower areas.....	208
Figure 20-20 - Fixtures not permitted .....	209
Figure 20-21 - Clothes closet luminaires.....	210
Figure 20-22 - Clothes closet luminaires (b) .....	211
Figure 20-23 - Required Clearances of Panel Boards.....	213
Figure 20-24 - Multiwire Branch Circuits .....	215
Figure 20-25 - Grouping .....	215
Figure 20-26- Maximum Height Requirements for Circuit Breaker.....	216
Figure 20-27 - Location of pool receptacles.....	218
Figure 20-28 - Junction box location and listing requirements.....	220
Figure 20-29 - Bonding Requirements for a pool area.....	221
Figure 20-30 - Bonding requirements for Swimming Pools.....	224
Figure 20-31 - Minimum cover for cable burial .....	226
Figure 20-32 - Neutral conductor identification.....	227
Figure 20-33 - Environmental Air Wiring Methods .....	228
Figure 23-1 - Pipe Location with Respect to Footings.....	238
Figure 23-2 - Connection of Stack Outside of Wall .....	239
Figure 24-1 - Drainage Pipes above Water Tanks.....	242
Figure 24-2 - Running Trap Vent Offset.....	245
Figure 24-3 - Kitchen/Laundry Vented Trap .....	245
Figure 25-1 - Dry Vent Connection to Horizontal Drain .....	252
Figure 26-1 - Allowable cesspit location .....	260
Figure 26-2 - Cesspit Construction.....	262
Figure 32-1 - Accessibility for Multi-Dwellings .....	291
Figure 32-2 - Accessibility to Dwelling Units.....	299

---

Figure 32-3 - Site Access by Vehicle May Be Acceptable.....	301
Figure 35-1 - Typical Nail Types and Sizes.....	331
Figure 37-1 - Vertical and Beveled Changes in Level .....	340
Figure 38-1 - Sun tube light.....	394
Figure 38-2 - Elevation modified for Bermuda, illustrating passive energy strategies.....	399
Figure 38-3 - Air Flow Calculation.....	400
Figure 38-4 - Passive Energy Design Examples .....	401
Figure 38-5 - Solar PV Illustration.....	402
Figure 38-6 - Solar Panel Detail Using Traditional Construction Practices.....	404
Figure 38-7 - Passive, Batch Solar Water Heating .....	406
Figure 38-8 - Solar Panel Detail Using Traditional Construction Practices.....	408
Figure 38-9 - Permeable Pavement Section .....	411
Figure 38-10 - Visual examples of Permeable Paving.....	414



## LIST OF TABLES

Table 4.1 - Minimum Glazing Areas for Residential Rooms.....	58
Table 4.2 – Minimum natural ventilation areas for room .....	59
Table 4.3 - Minimum Natural Ventilation Areas for Rooms.....	59
Table 5.1- Concrete Masonry Retaining Walls: Size of Blockwork & Reinforcing .....	67
Table 5.2 - Masonry Retaining Walls: Foundation Size & Reinforcing.....	67
Table 5.3 - Required depth of Keys in Footings for Wall Type 2 .....	67
Table 5.4 - Free Standing Wall Construction.....	72
Table 5.5 - Minimum size of Drainage Soakaway Pits .....	73
Table 6.1 - Minimum Allowable Size and Reinforcing of Concrete Strip Foundations.....	78
Table 8.1 - 6” thick slabs .....	88
Table 8.2 - 8” thick slabs .....	88
Table 8.3 - 6” thick slabs .....	89
Table 8.4 - 8” thick slabs .....	89
Table 8.5- 5” thick slabs .....	90
Table 8.6 - 6” thick slabs .....	90
Table 8.7- Simply Supported Floor Joists under Residential Rooms: Max Allowable Live Load 40 psf .....	92
Table 8.8 - Simply Supported Floor Joists under Exterior Balconies: Max Allowable Live Load 60 psf .....	92
Table 8.9 - Minimum Allowable Load of Joist Hanger Connections.....	94
Table 8.10 - Connection details for Timber Stringers to Masonry Walls .....	94
Table 8.11 Cantilevered Floor Joists under Exterior Balconies: Maximum Allowable Live Load 60 lbs/ sq.ft. ....	96
Table 8.12 - Minimum Allowable load of connector from Header joist to Trimming joist .....	97
Table 9.1 - Internal Walls: Maximum spacing between Lateral supports .....	102
Table 9.2 - Exterior Walls: Maximum spacing between Lateral Supports.....	103
Table 9.3 - Lintels Sizes: Supporting Roof ONLY (up to 20’ span).....	113
Table 9.4 - Lintels Sizes: Supporting Floor ONLY (spans up to 10’) or Roof ONLY (spans up to 30’) OR Floor (up to 8’ span) AND Roof (up to 8’ span) .....	115
Table 9.5 - Lintels Sizes: Supporting Roof (up to 15’ span) AND Floor (up to 10’ span) or Floor ONLY (up to 15’ span) .....	117
Table 9.6 - Lintels Sizes: Walls Supporting: Roof (up to 20’ span) AND Floor (up to 15’ span) OR Floor ONLY (up to 25’ span).....	119
Table 10.1 - Minimum Allowable Capacity of Hurricane Clips for Lightweight Pitched Roofs & Lightweight Fully Enclosed Flat Roofs .....	123
Table 10.2 - Minimum Allowable Capacity of Hurricane Clips for Flat Unenclosed Porch Roofs .....	124
Table 10.3 - Minimum Size of Rafters for Flat Roofs .....	128
Table 10.4 - Minimum Connection Details for Rafters of Bda Slate Flat Roofs.....	128
Table 10.5 - Minimum Connection Details for Rafters of Lightweight Flat Roofs .....	128
Table 10.6 – Collar tie at 1/3 roof height (Bermuda slate roof) .....	130
Table 10.7 - Collar tie at 1/3 roof height (Lightweight roof).....	130
Table 10.8 – Collar tie at 1/2 roof height (Bermuda slate roof).....	132
Table 10.9 – Collar tie at 1/2 roof height (Lightweight roof) .....	132
Table 10.10 - Collar tie at wall plate (Bermuda slate roof).....	134
Table 10.11 - Collar tie at wall plate (Lightweight roof) .....	134
Table 13.1- Minimum Cover to Reinforcing Bars.....	147
Table 13.2 - Minimum Allowable Lap Lengths for Reinforced Concrete.....	147
Table 13.3 - Alternative bar sizes.....	147
Table 13.4 - Alternative Mesh Sizes .....	148
Table 14.1- Required Mixes for Building Mortar .....	149
Table 14.2 - Required Mixes for Plastering Mortar.....	150

Table 14.3 - Minimum Allowable Lap Lengths for Reinforced Masonry .....	151
Table 14.4 - Alternative Bar Sizes .....	151
Table 15.1 - Minimum Timber Properties of Standard Dressed Lumber .....	153
Table 15.2 - Allowable Placement Distances of Bolts in Timber .....	154
Table 18.1 - Minimum Water Depths Based on Height of Diving Board.....	169
Table 18.2 - Minimum Clearances of Overhead Conductors above Swimming Pools .....	170
Table 19.1 - Minimum Mechanical Fresh Air Ventilation rates (Intake/Supply Air).....	181
Table 19.2 - Minimum Mechanical Exhaust Rates.....	181
Table 20.1 - Summary of Receptacle Outlet locations .....	202
Table 22.1 - LP Gas Pipe .....	230
Table 22.2 - Location of containers.....	231
Table 24.1 - Maximum Allowable Spacing of Hangers.....	239
Table 24.2 - Nominal Pipe Sizes.....	240
Table 25.1 - Underground sewer and drain pipes.....	244
Table 25.2 - Above Ground Drainage Piping .....	246
Table 25.3 - Drainage Fixture Values for Various Plumbing Fixtures .....	246
Table 25.4 - Maximum Fixture Units Allowed to be connected to Branches and Stacks.....	247
Table 25.5 - Fittings for Change in Direction .....	247
Table 25.6 - Minimum Trap Sizes for Fixtures .....	249
Table 26.1 - Maximum distance of fixture trap from vent .....	252
Table 26.2 - Common Vent Sizes.....	253
Table 26.3 - Wet Vent Size.....	253
Table 26.4 - Waste Stack Vent Size.....	254
Table 26.5 - Size of Combination Waste and Vent Pipe .....	256
Table 27.1 - Cesspit top construction 6" thick slab .....	261
Table 27.2 - Cesspit top construction 8" thick slab .....	261
Table 29.1 - Above Ground Water Tank Wall Construction .....	271
Table 30.1 - Size of Vertical Rainwater Leaders.....	273
Table 30.2 - Size of Horizontal Rainwater Drains .....	273
Table 32.1 - Maximum Run Length (feet) <sup>a</sup> .....	283
Table 32.2 - Mechanical Ventilation System Fan Efficacy .....	284
Table E.1 - Sun path and measures that control solar heat gain .....	397

## 1 SCOPE AND INTERPRETATION

---

### 1.1 SCOPE

This code is applicable only to residential dwellings not exceeding 5000 square feet in area on any floor level and not exceeding two storeys or 24 feet in height.

Multiple single family *dwelling units* located above or adjacent to other single family *dwelling units* (such as condominiums) will be considered as part of this code as long as the fire separation requirements of Chapter 18 are complied with and as long as each *dwelling unit* has its own **independent means of egress**. This means that no common egress elements serving more than one dwelling unit are utilized in the design.

The code sets down construction requirements for 'traditional' Bermuda type buildings consisting of masonry walls, concrete foundations, concrete and/or timber floors and timber roof within the limitations set down in section 1.3.

### 1.2 INTERPRETATION

In this code the word 'shall' indicates a requirement that is mandatory. The use of the word 'should' indicates a recommended practice. The use of the term 'the code' shall refer to this code, the 'Bermuda Residential Building Code 2014'. The appearance of certain words and phrases in italic type means that they have been defined and attention is drawn to their definition to ensure understanding of their meaning. The standards laid down in this code are the **minimum requirements** for compliance. There may be occasions when registered design professionals feel it is good practice to exceed these standards.

### 1.3 LIMITATIONS

This code applies only to buildings within the following limitations:

- a) The maximum height shall be 2 storeys and the eaves height shall not exceed 24' above finished grade. The first storey shall be the storey closest to grade. A basement shall be considered a storey for the purpose of this code when the distance from grade to the finished floor surface above the basement is greater than 6' for more than 50% of the total perimeter.
- b) The maximum gross floor area of the building on any floor level shall not exceed 5000 square feet.
- c) The roof pitch of the main house buildings shall not be less than 5 in 12 (22.6°) or greater than 10 in 12 (39.8°). Lean-to structures such as porches shall have roof slopes between 1 in 12 (4.8°) and 3 in 12 (14°).
- d) Design loads shall not exceed those described in section 1.7.

### 1.4 NOT COVERED IN CODE

Where a type or method of construction or a safety provision is not covered in this code, the provisions of the current *Bermuda Commercial Building Code* shall take effect. Where a conflict

exists between this code and the current *Bermuda Commercial Building Code*, this code shall take precedence.

### 1.5 VARIANCES TO THE CODE FOR LISTED BUILDINGS

The provisions of this Code, relating to the construction, repair, alteration, addition, and restoration of existing buildings and structures listed by the Minister under the provisions of section 30 of the Development and Planning Act 1974, shall not be mandatory. Any variance to the Code sought for such work shall require the support of the Historic Buildings Advisory Committee. Finally, any variance sought under this section must satisfy the Building Official that the intent of the Code, in terms of public health, safety and welfare, is maintained.

### 1.6 EXEMPTION

Where some form of construction is desired that is outside the normal scope of this code it shall require design by a qualified person and submission to the *Building Official* for exemption. There may be instances when the magnitude of the variation from the code is significant enough that the Building Official will deem this code no longer applicable. In this instance, the design will be required to conform to the current Bermuda Commercial Building Code.

### 1.7 USING THE TABLES

Where a design situation falls between the parameters provided in the Tables the next largest size shall be selected (for example roof spans are provided in 2' increments, therefore for a span of 15' the next application span for using the Tables would be 16').

### 1.8 DESIGN PARAMETERS

This code has been based on the loading and design parameters listed below:

#### Live Loads:

Ceiling spaces without storage	5lb/ft <sup>2</sup> or a 200 lb concentrated
Habitable Areas	40 lb/ft <sup>2</sup>
Balconies	60 lb/ft <sup>2</sup>
Garages – Passenger Cars	50 lb/ft <sup>2</sup> or 2000lb on 20 in <sup>2</sup>
Wind loading – Base on:	Basic Wind Speed of 150 mph* Exposure Category C or D (ASCE 7-95)
Retaining Wall Earth Loading – Equivalent Fluid of:	30 lbs per cubic ft
Partitions	20 lb/ft <sup>2</sup> on plan area
Guardrails and Handrails	200 lb concentrated load (in any direction)
Roof loads	5lb/ft <sup>2</sup> or a 200 lb concentrated load

#### Dead Loads

Bermuda Slate Roof	26lb/ft <sup>2</sup>
Foam / Built up roof with cement board underlay	9 lb/ft <sup>2</sup>
Masonry walls	(As per ASCE 7- 95)
Plaster ceilings on Gypsum Board	8 lb/ft <sup>2</sup>

#### Allowable Live Load Deflections

Rafters, Ceiling Joists and Floors	Span / 360
------------------------------------	------------



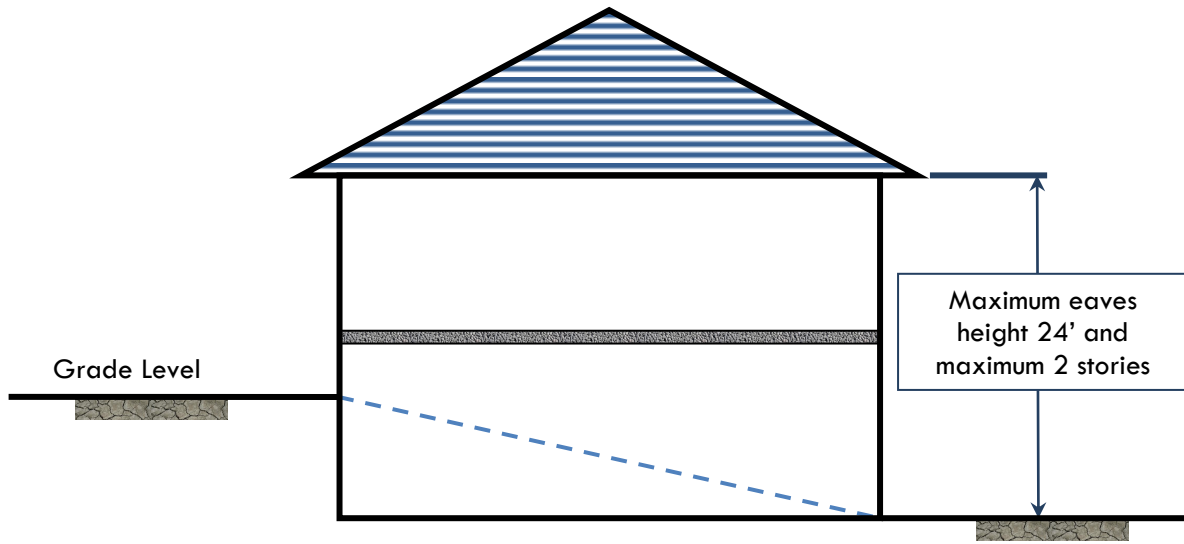

Elevation of Building

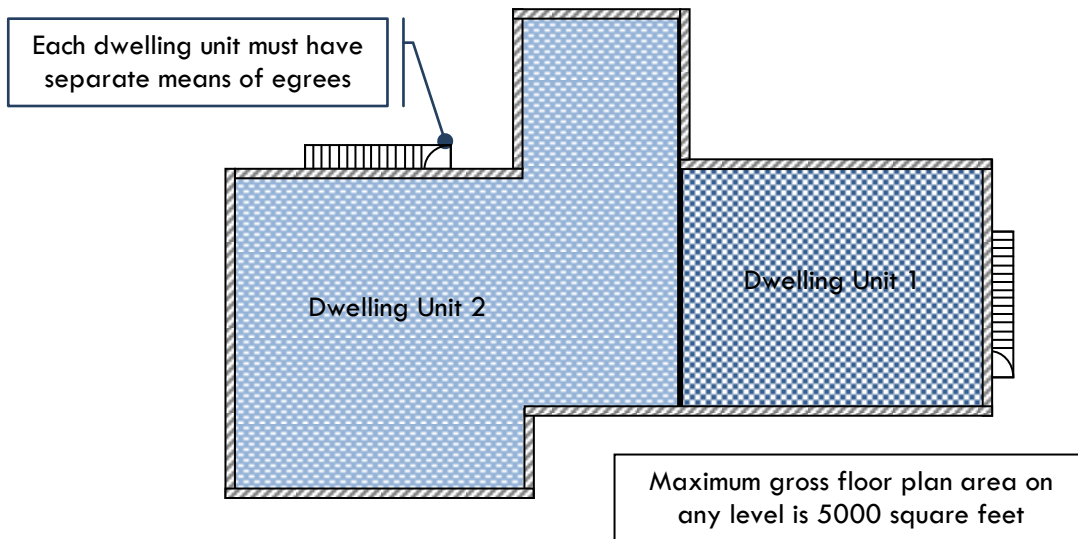

Floor Plan of Building

Figure 1-1 – Building Limitations



## 2 ADMINISTRATION

### 2.1 BUILDING PERMIT REQUIRED

A building permit is required for the following building operations:

- a) the excavation or quarrying of any land, including that under an existing building;
- b) the **demolition of any building** or structure **except** where the following conditions are met:
  - The building or structure is located a minimum of 25 feet from any road or boundary; and
  - the building does not contain any old vinyl floor tiles (exceeding 30 years old) or any pipe insulation (exceeding 30 years old) or asbestos corrugated roofing; and
  - the Department of Health has conducted a preliminary inspection to confirm the above.
- c) the erection of any building or structure, whether permanent or temporary;
- d) the carrying out of any structural alteration or extension of any building, including the removal of any parts of internal load bearing walls or of fire partitions or walls;
- e) the carrying out of works for the purpose of effecting a material change in use of the building or premises;
- f) the installation or renewal of an electrical system;
- g) the installation or renewal of any plumbing or drainage or sewage disposal system;
- h) the installation or renewal of any gas fuel system;
- i) the reconstruction of a building;
- j) the conversion of a movable object into a building;
- k) the removal of a building from one site and its re-erection elsewhere;
- l) the roofing over of an open space between walls or buildings;
- m) the installation, renewal, renovation or change of any mechanical system containing more than 6.6 lbs (3kg) of refrigerant; and,
- n) the installation of any fuel burning system other than a cook top or oven even if the fuel burning system piping is not being altered.

It is an offence under the Building Act 1988 to perform any of the works listed above unless a permit has been obtained in writing from the *Building Official*.

### 2.2 BUILDING PERMIT NOT REQUIRED

A building permit is not required for the normal repairs and maintenance of a building. Such repairs shall not include the cutting away of any loadbearing wall, or of a fire separation wall or portion thereof. Nor shall such repairs include the addition to, alteration of, replacement or relocation of any plumbing, drainage, vent, gas or similar piping or electrical wiring.

A permit is **not** required for internal work that does **not** involve:

- excavation;
- structural, electrical, gas, plumbing or drainage alterations;

- a change in the egress of the building;
- a change in the number of *dwelling units*; or,
- a change in use of the building.

## **2.3 EXISTING STRUCTURES**

Additions, alterations or repairs to any structure shall conform to that required of a new structure, without requiring the existing structure to comply with all the requirements of this code. However such additions, alterations or repairs shall not cause any structure to become unsafe or adversely affect the performance of the structure. In addition, if the structure is found to contain unsafe structural, electrical, gas, fire, egress or sanitary components then the areas identified shall be rectified to the direction of the *Building Official*.

## **2.4 APPLICATION FOR PERMIT**

### **2.4.1 FORM OF APPLICATION**

The application for a permit shall be submitted in such form as the Building Official prescribes.

### **2.4.2 FEES FOR APPLICATION**

The fees shall be as prescribed under the Government Fees Act.

### **2.4.3 BY WHOM APPLICATION IS MADE**

Application for a permit shall be made in the name of the owner or occupier of the building or land. The application can be made by the owner or the agent employed in connection with the proposed work. If the application is made by anyone other than the owner, then the application form shall be signed by the owner.

## **2.5 CONSTRUCTION DOCUMENTS**

The application shall be accompanied by three sets of plans drawn to scale with sufficient clarity and detail to show the nature of the work performed. Appendix A lists a detailed description of the drawings and information that are required for a building permit submittal. The name of the draughtsman of all plans shall be identified on all construction documents as well as the company that they represent (if a company is involved). The Building Official is permitted to waive the requirements for submitting construction documents when the scope is of a minor nature.

## **2.6 PERMITS**

### **2.6.1 OFFENCE**

It is an offence under the Building Official Act 1988 to perform any of the building operations listed in section 2.1 unless a permit has been obtained in writing from the Building Official prior to such works commencing and a valid permit is in effect at all times.

### **2.6.2 APPROVED PLANS**

When the *Building Official* is satisfied that the plans are in accordance with the Building Regulations he/she shall;

- a) stamp or endorse the three sets of plans with the words 'approved';
- b) retain one set of the plans as approved; and,
- c) return two sets of the plans to the applicant who shall keep one set on the building site, available at all reasonable times, for inspection by the *Building Official*.

### **2.6.3 REVOCATION OF THE PERMIT**

Where a permit was issued by virtue of false or inaccurate information on the original submission, the Building Official may revoke the permit if he/she deems necessary.

### **2.6.4 CONDITIONS OF PERMIT**

The permit may be issued with conditions listed as deemed necessary by the *Building Official*. The applicant, on receipt of the building permit, shall sign for acceptance of these conditions. If the applicant objects to any of these conditions, he/she shall notify the *Building Official* prior to signing and the issuance of the permit will be subject to satisfactory resolution of the items involved.

### **2.6.5 BUILDING APPEALS TRIBUNAL**

Any question or dispute arising between the *Building Official* and the applicant as to whether the plans are defective or whether the proposed work would contravene any of the building regulations may be referred to the *Building Appeals Tribunal* as per the procedures described in the Bermuda Building Act 1988 or any subsequent amendment.

### **2.6.6 COMPLIANCE WITH CODE**

The permit shall be a license to commence works. It shall not be constructed as authority to set aside any of the provisions of the code. The issuance of a permit based upon construction documents and other data shall not prevent the Building Official from thereafter requiring the correction of errors in the construction documents and other data, or from preventing building operations from being carried out when in violation of this code.

### **2.6.7 COMPLIANCE WITH PERMIT**

All works shall conform to the approved application and the approved construction documents and any approved amendments.

### **2.6.8 AMENDMENTS**

Application for amendment to a previously issued permit shall be in triplicate and such amendment shall be considered only if it is in accordance with the code and it in no way changes the scope of the original project. The submission of amended documents shall be in accordance with Appendix A.

### **2.6.9 VALIDITY OF PERMIT**

The permit is valid for a maximum period of 5 years from the date of issuance of the permit. No construction work shall take place without a valid permit being in place. Note that valid planning permission must also be in force at all times.

### **2.6.10 RENEWAL OF PERMIT**

A permit may be renewed one time only for a period of 2 years from the original expiration date. For renewed permits, the construction works will be upgraded to meet the amended provisions of the latest adopted version of the code.

**2.6.11 PERMIT EXPIRATION**

A permit that has expired for more than six months or a permit that has already been renewed one time shall not be renewable. A new application and payment of the full permit fee will be required.

**2.6.12 PERMIT NUMBER TO BE DISPLAYED**

The building permit number shall be posted prior to the commencement of any work and shall be left on display until a final certificate of completion and occupancy for the project has been issued. The number shall be visible from the road and the text shall be a minimum of 6" in height.

**2.6.13 PERMIT AND INSPECTION CARD**

A permit and inspection card will be issued with the building permit. This card shall be posted conspicuously at the site and be readily accessible during all reasonable times to the *Building Official*.

**2.7 INSPECTIONS****2.7.1 REQUIRED BUILDING & ELECTRICAL INSPECTIONS**

The permit holder shall, at least one working day before proceeding with or concealing work which requires inspections, notify the *Building Official* that such inspection is needed. These works shall not commence until the inspection has been carried out and *approved*. Further, all structural work designed by a registered engineer shall be inspected for conformance by a registered engineer and a certificate of conformance shall be provided prior to inspection by the building official. For the purposes of this section, work which requires inspection includes:

- a) commencement and/or setting out of the project prior to any building or excavation work;
- b) excavation and foundation reinforcing prior to pouring footing concrete;
- c) structural reinforcing in all structural concrete and reinforced masonry prior to pouring concrete;
- d) all structural members prior to concealing those members;
- e) roof framing, battens and sheathing prior to installation of roof slates, shingles, sheet roofing or roof membrane;
- f) all electrical work prior to concealing;
- g) re-commencement of work if the project has been suspended for a prior exceeding six months; and
- h) completion of building and electrical work prior to occupancy and or use.

A request for inspection shall be in the form prescribed by the *Building Official*.

**2.7.2 MECHANICAL SYSTEM INSPECTIONS**

Building owners shall provide documentation by a qualified person to Building Control that the mechanical installation (fuel burning or HVAC system) complies with the applicable Building Codes in force noting all changes made to the approved Building Control drawings and calculations.

**2.7.3 HEALTH INSPECTIONS**

For the inspection of Plumbing and Drainage installations, the permit holder or contractor shall, at least one working day before proceeding with or concealing work which requires inspections,

notify the Department of Health that such inspection is needed. These works shall not commence until the inspection has been carried out and approved. For the purposes of this section, work which requires inspection includes:

- a) roughing in of all pipework prior to concealing;
- b) cesspit location prior to excavation;
- c) cesspit walls after excavation;
- d) pressure testing of all water supply, drainage, sewer and vent piping; and
- e) final inspection after installation of all fixtures.

#### **2.7.4 VIOLATIONS**

Where work which requires inspection has been concealed, the *Building Official* may order the removal of materials concealing such work and the cost of such removal shall be borne by the owner. Any person who proceeds with, or conceals any work, in respect of which an inspection is required, is guilty of an offence.

#### **2.7.5 RE-INSPECTIONS**

Where an inspection for a particular portion of the works is requested and the work is not ready for inspection or is incorrect, then a re-inspection shall be necessary. In this instance, the Building Official may require that an inspection fee be paid prior to the re-inspection being performed.

#### **2.7.6 RIGHT OF ENTRY**

For the purpose of carrying out inspections for compliance of the development with the requirements of this code, the Building Official shall have a right to enter any premises at all reasonable hours. Further, the Building Official shall have the right during final inspection to take photos to capture all site works completed as per the approved plans, in addition to any other works as deemed necessary by the Building Inspector.

#### **2.8 FIELD CORRECTION NOTICES**

Where works are being carried out that are not in accordance with the code, the approved documents, the Building Act, the approved planning conditions, or any other regulations related to the development, the *Building Official* may issue a field correction notice in accordance with section 23B(1) of the Building Act 1988. This written notice may be served by handing it to an apparently responsible person or affixing it in a conspicuous location at the site. For the purpose of this section an apparently responsible person shall mean the owners, trustees, architect, contractor, project manager or any other person appearing to the *Building Official* to have an influence over the development. The field correction notice shall identify the areas of deficiency and give reasonable time for any required changes to be made. For the purpose of this section, reasonable time shall mean the generally accepted time by construction industry standards to perform a task.

#### **2.9 STOP WORK NOTICES**

Where works are being carried out that are not in accordance with the code, the approved documents, the Building Act, the approved planning conditions, or any other regulations related to the development, the *Building Official* may issue a stop work notice in accordance with section

23B(2) of the Building Act 1988. This written notice may be served by handing it to an apparently responsible person or affixing it in a conspicuous location at the site. For the purpose of this section an apparently responsible person shall mean the owners, trustees, architect, contractor, project manager or any other person appearing to the *Building Official* to have an influence over the development. No work shall continue on works that have been issued with a stop work notice until approval to proceed is issued by the *Building Official* in written form.

## **2.10      DIRECTIONS**

The Building Official shall have the authority as necessary in the interests of public health, safety and general welfare, to issue directions in order to interpret and implement the provisions of the code and to secure the intent thereof. Such directions shall be confirmed in writing by the Building Official in a timely manner.

## **2.11      CERTIFICATE OF COMPLETION AND OCCUPANCY**

### **2.11.1      NEW BUILDINGS**

A building or structure that is erected shall not be used or occupied in whole or in part until a certificate of completion and occupancy has been issued by the *Building Official*.

### **2.11.2      BUILDINGS ALTERED**

A building or structure that is enlarged, extended or altered shall not be occupied or used until the certificate has been issued by the Building Official. This code shall not require the discontinuance of use and occupancy of a lawful existing building or structure, unless such use is deemed to endanger public safety and welfare.

### **2.11.3      CONDITIONS OF ISSUANCE**

A certificate of completion and occupancy shall not be issued until all works for which the permit has been issued have been completed. This shall include all conditions of planning approval.

### **2.11.4      PARTIAL OCCUPANCY CERTIFICATES**

Upon written request by the holder of a permit, the *Building Official* may issue a partial certificate of completion and occupancy before the entire work has been completed, provided such portions will be occupied safely prior to full completion of the building or structure without endangering life or public safety. The final dwelling unit in a multiple development will not be granted partial occupancy until all works have been completed and *approved*.

### **2.11.5      ISSUANCE OF CERTIFICATE**

Upon receipt of written request from the owner of a building or structure, the Building Official shall issue a certificate of completion and occupancy within ten working days if all works to which the permit relates have been completed and are in accordance with the approved permit documents, the planning conditions and the adopted codes of practice. A certificate of completion and occupancy shall not be issued if:

- a) A written request has not been submitted by the owner;
- b) Compliance with the approved plans is not evident; and



- c) All conditions imposed by the DAB have not been met unless a sound and justified reason is clearly specified and accepted by the *Building Official*.

### **2.11.6 APPEARANCE OF THE DEVELOPMENT**

If the appearance has been altered in any way, i.e. a chain link fence approved but a picket fence is installed or if blinds are approved but not installed at the time of inspection, then the changes will have to be approved at the discretion of the Building Official, assuring there are no historical implications.

### **2.11.7 TEMPORARY OCCUPANCY**

The *Building Official* is authorized to issue a temporary certificate of occupancy before the completion of the entire work covered by the permit, provided that such portion or portions shall be occupied safely. The *Building Official* shall set a time period during which the temporary certificate of occupancy is valid.

### **2.12 SUPPLY OF CURRENT**

The supply of electrical current shall not be made available to an electrical wiring installation until the certificate of completion and occupancy or the partial certificate of occupancy has been issued and a copy forwarded to the Bermuda Electrical Light Company.

#### **2.12.1 RENOVATION/DEMOLISHED STRUCTURES POWER SUPPLY**

The status of the existing power supply shall be changed from permanent to temporary for the duration of the construction and meters shall not be fully energized until a Completion of Use and Occupancy Certificate has been issued and a copy sent to the Bermuda Electric Light Company.



### **2.13 OFFENCES**

Any person who:

- a) performs a building operation without first obtaining a building permit from the Building Official;
- b) erects, constructs, alters or repairs a building or structure other than in accordance with the conditions of a valid building permit or in violation of an approved plan or direction of the Building Official;
- c) fails to comply with a permit or a certificate issued under the provisions of this code; or
- d) fails to comply with a field correction notice or stop work notice

is guilty of an offence under the Building Act 1988.

Offences are punishable on conviction as described in the Building Act 1988 or any subsequent amendments.

**2.14      PLANNING APPROVAL MUST BE IN FORCE**

Nothing in this code shall infer compliance with any planning regulations. Planning permission in accordance with the current Development and Planning Act must be obtained prior to any building permit being issued and must be currently in force prior to any building operations being performed.

### 3 DEFINITIONS, ABBREVIATIONS, SYMBOLS & CONVERSIONS

---

#### 3.1 SCOPE

Unless otherwise expressly stated, the following words, terms and abbreviations shall, for the purposes of this code, have the meanings defined in this chapter, unless inconsistent with the context.

#### 3.2 INTERCHANGEABILITY

Words used in the present tense include the future; words and phrases used in the masculine gender include the feminine and neuter.

#### 3.3 TERMS NOT DEFINED

Where terms are not defined in this chapter, such terms shall have the ordinarily accepted meanings such as the context implies.

#### 3.4 DEFINITIONS

**Agent:** A person that acts on behalf of the owner of the property for the purpose of obtaining building permit approval and/or overseeing the construction works.

**Air Gap (plumbing):** The unobstructed vertical distance through free atmosphere between the lowest opening from a water supply discharge to the flood level rim of a plumbing fixture.

**Ancillary Rooms:** A room that is ancillary to the main *habitable rooms* in a building and includes bathrooms, toilet rooms, hallways, laundries, walk-in-closets, pantries and similar spaces.

**Applicant:** Owner or occupier of the building or land (see section 2.4.3 for requirements).

**Approved Agency:** Underwriters Laboratories, Underwriters Laboratories Canada or other such internationally recognized organizations as the Building Official may decide at his/her discretion.

**Approved:** Acceptable to the *Building Official*.

**Attic:** The space between the ceiling joists/collar ties and the roof rafters.

**Backwash Pit:** An approved soakaway pit excavated in the ground for the purpose of enabling adequate drainage of swimming pool backwash water.

**Basement:** That part of a building which is partly or completely below grade.

**Bathroom:** An area containing a basin with one or more of the following: a toilet, a bathtub or a shower.

**Bay Window:** A window projecting beyond the wall line of the building.

**Belt Course:** See Bond Beam.

**Bermuda Commercial Building Code:** The long form of building code regulations, enacted under the Building Act 1988, that covers all building works in Bermuda.

**Blocking (bridging):** The stiffening of adjacent timber joists with cut-in sections of timber the same size as the joist.

**Bond Beam:** A horizontal reinforced concrete beam cast into or on top of a masonry wall. It is used to tie the walls together. Often referred to as a belt course or concrete belt.

**Branch Interval:** A vent connecting two or more individual vents with a vent stack or stack vent.

**Branch:** Any part of a piping system apart from a riser, main or stack.

**Building Drain (foul water):** The lowest part of the drainage piping system that collects the discharge from all other foul water drainage piping inside the house and conveys it to the building sewer (waste water) outside the building wall.

**Building Drain (waste water):** The lowest part of the drainage piping system that collects the discharge from all other waste water drainage piping inside the house and conveys it to the building sewer (waste water) outside the building wall.

**Building Official:** The Director of Planning (includes his/her authorized representatives)

**Building Sewer (foul water):** That part of the drainage piping system that exceeds from the building and conveys foul water from the bathroom fixtures to a cesspit or public sewer.

**Building:** Means any permanent or temporary building and includes any other structure or erection of whatever kind or nature.

**Ceiling Height:** The clear vertical distance from the finished floor to the finished ceiling.

**Cesspit:** A covered excavation in the ground that receives waste materials and allows seepage of the liquids into the surrounding ground.

**Chimney:** A passageway for conveying fireplace gases to the outside.

**Cleanout:** An access opening in the drainage system utilized for the removal of obstructions.

**Clear Width:** The net unobstructed width of a door or window opening without projections into such width.

**Collar Tie:** A member connecting paired rafters below the level of the ridge board of a roof.

**Concrete fill:** A flowable mixture of cement, sand, aggregate and water used for filling cells of blockwork walls.

**Dead End (plumbing):** A branch of a drainage system that terminates at a developed length of 2 feet or more by means of a plug, cap or other closed fitting.

**Dead Load:** The self weight of a structure and any permanently installed loads acting on it.

**Developed Length (plumbing):** The length of a pipe measured along the centerline of the pipe and fittings.

**Development Plan:** Development Plan as specified in the Development Planning Act 1974.

**DOT:** U.S. Department of Transportation.

**Drainage Fixture Unit (DFU):** A measure of the probable discharge into the drainage system by various types of plumbing fixtures.

**Dwelling Unit:** A single unit providing complete, independent living facilities for one or more persons including permanent provisions for living, sleeping, eating, cooking and sanitation.

**Edge Distance:** The distance from the edge of a timber member to the centre of the nearest bolt, measured perpendicular to the grain.

**Effective Opening:** The minimum cross-sectional area at the point of water-supply discharge.

**End Distance:** The distance measured parallel to the grain from the square cut end of a timber member to the centre of nearest bolt.

**Estate Road:** A road other than a public road that gives access to 3 or more dwelling houses and over which the occupants of the dwelling houses have a right of way.

**Exit:** That part of a means of egress that opens directly to a safe outdoor area.

**Firebox:** The space inside a fireplace where the combustible material is burnt.

**Fire resistance rating:** The time in hours or minutes that materials or their assemblies will resist fire exposure as determined by the test procedures set forth in ASTM E-119.

**Fire resistance:** That property of materials or their assemblies which prevents or retards the passage of heat, hot gases or flames under conditions of use.

**Flat Roof:** A shallow monopitch roof such as a porch or lean-to roof with a minimum slope of 1 in 2 and a maximum slope 3 in 12.

**Flue:** The vertical opening to the outside to provide for the release of smoke from the fireplace.

**Footcandle:** A unit of illuminance measured in lumens per square feet (see also 'lux').

**Foul Water:** Water that is contaminated with soil water and waste water in a foul drain.

**Foundations:** Those parts of a building that are bearing on the ground and are used to transmit and distribute the loads of the building to the ground.

**Fullway valve:** A valve that in the open position has an opening cross-sectional area equal to a minimum of 85% of the cross-sectional area of the connecting pipe.

**Gable:** The triangular part of an exterior wall between the planes of the roof and the line of the eaves.

**Gas:** Liquefied petroleum gas (LPG) in accordance with NFPA 58 and NFPA 54.

**Gathering:** Narrowing of the fireplace chimney above the throat and leading to the flue. Forms the sides of the smoke chamber.

**Grade:** The finished ground level adjoining the building at all exterior walls.

**Habitable room:** Any room in a building meeting the requirements of this code for sleeping, living, cooking or dining purposes, excluding such enclosed places as closets, storage spaces, pantries, bath or toilet rooms, hallways, laundries, utility rooms and similar spaces.

**Handrail:** A horizontal or sloping rail intended for grasping by the hand for guidance or support, for arresting falls on the adjacent walking surface and for providing a visual clue for change in elevations.

**Header Joists:** A short floor joist that encloses one side of a rectangular hole in a timber floor, carrying the full length trimmed (curtailed) joists that are cut off for the hole.

**Hearth:** The area that exceeds the floor of the fireplace (firebox) beyond the face of the fireplace.

**Herringbone strutting:** The stiffening of adjacent joists by bridging between them with pairs of light struts forming crosses, fixed from the bottom of each joist to the top of its neighbor.

**Highway:** Any road or place over which the general public has right of way.

**Holding Tank:** An *approved* watertight receptacle for collecting and holding sewage.

**Hot Water:** Water that is supplied to plumbing fixtures at a temperature of between 120 and 140 degrees Fahrenheit.

**Hydromassage bathtub:** A bathtub equipped with a re-circulating piping system, pump and associated equipment. It is designed so it can accept, circulate and discharge water upon each use.

**Inspector:** An officer who is responsible for assisting the Building Official in the performance of his/her duties.

**Joist Hangers:** Various connectors for timber framing made of galvanized steel pressed to shape with punched nail holes.

**Joist:** A horizontal framing member that directly supports the floor or ceiling lining.

**Kitchen trap:** An *approved* trap located outside the kitchen wall and designed to provide an air gap between the kitchen drainage piping and the *building sewer* (waste water) to the cesspit.

**Kitchen:** An area used, or designated to be used, to prepare food.

**Lateral Support Wall:** A wall that resists horizontal forces applied in the plane of the wall.

**Lath:** Horizontal timber members installed on a timber roof to support the roofing slates.

**Lavatory:** A hand basin for washing up.

**Links:** A single bar stirrup between one top bar and one bathroom bar.

**Lintel:** A beam placed over an opening or a recess in the wall which supports the construction above.

**Listed:** Equipment or materials included in a list published by an organization acceptable to the Building Official and concerned with product evaluation, that maintains periodic inspection of production of listed equipment or materials and whose listing states that either the equipment or material meets appropriate standards or has been tested and found suitable for use in a specified manner.

**Live Load:** A temporary load that can be removed or replaced on a structure.

**Load:** Forces or other actions that arise on structural systems from the weight of all permanent construction, occupants and their possessions, or from various environmental effects.

**Loadbearing wall:** A wall that supports vertical loads other than its own weight, i.e. from floors. Ceiling joists, roofs or any combination thereof.

**Loaded Edge:** When a timber member is loaded perpendicular to the grain, the loaded edge is defined as the edge in the direction toward which the bolt is acting.

**Loaded End:** When a timber member is loaded parallel to the grain, the loaded end is defined as the direction towards which the bolt is acting.

**Location, Damp:** Partially protected locations under canopies, marquees, roofed open porches and interior locations subject to moderate degrees of moisture such as unsealed basements.

**Location, Dry:** A location not normally subject to dampness or wetness. A location classified as dry may be temporarily subject to dampness or wetness, as in the case of building under construction.

**Location, Wet:** Installations underground or in concrete slabs or masonry in direct contact with the earth, and locations exposed to the weather.

**Lot Line:** A line dividing one lot from another, or from a road or any public place.

**LPG portable exchange cylinder:** A portable container constructed to DOT cylinder specifications with a maximum water capacity of 100 lbs.

**LPG storage container:** A container constructed to DOT cylinder specifications with a maximum water capacity of 420 lbs or to ASME specifications with a maximum water capacity of 500 lbs, to be used in a stationary installation and site filled with LPG.

**Lux:** A unit of illuminance measured in lumens per square meter (see also 'footcandle').

**Main:** The principle pipe artery to which the branches are connected.

**Means of egress:** A continuous and unobstructed path of travel from any point in a building to the outside. The means of egress comprises vertical and horizontal means of travel and shall include intervening rooms, spaces, doors, hallways, ramps and stairs.

**Monopitch roof:** A roof that has only a single slope with no ridge line. Also known as a lean-to-roof.

**Mortar:** A mixture of cement, sand, and water used for bedding and jointing of block work. May also include lime or other approved additives.

**Nominal dimension:** The dimension used in naming something such as masonry blocks or timber. The actual size may differ by an allowable tolerance.

**Owner:** Includes any person having a legal interest in a property or a building.

**Partition:** A non loadbearing wall, one storey high used to divide building areas.

**Party Wall:** A shared wall on an interior lot line between two separate owned, attached buildings that also acts as a fire wall.

**Person:** Includes a corporation, firm, partnership, association, organization and any other group acting as a unit as well as individuals. It shall also include any executor, administrator, trustee or other representative appointed according to law. Whenever the word "person" is used in an article prescribing a penalty or fine, as to partnerships the word includes the partners thereof; as to associations the word shall include members thereof; and as to corporations and firms the word shall include the officer, agents and members who are responsible for any violation and shall include the directors thereof.

**Plaster:** Material for creating a smooth finish on a wall or ceiling surface.

**Plumbing Fixture:** A receptor or device which requires both a water-supply connection and a discharge to the drainage system.

**Qualified Person:** A person who having regard for his/her qualifications, practical knowledge of, and experience in the building industry, the Building Official considers to be qualified for the relevant sections of the code.

**Registered Architect:** An architect registered under the Architects Registration Act 1969 or any subsequent amendment.



**Registered Engineer:** An engineer under the Professional Engineers Registration Act 1972 or any subsequent amendment, and specializing in the area of engineering specifically referred to under that section of the code.

**Registered Surveyor:** An registered surveyor registered under the Professional Surveyors Registration Act 1997 or any subsequent amendment.

**Reinforcement:** Any form of reinforcing rod, bar or mesh that complies with the requirements of Chapter 12 and 13.

**Render:** Mortar mix of sand/cement used to finish wall surfaces.

**Repair:** The reconstruction or renewal of any part of an existing building for the purpose of its maintenance.

**Retaining Wall:** A wall used to resist the lateral displacement of soil or any other material.

**Riser (water pipe):** A water supply pipe which extends one full storey or more to convey water to branches or to a group of fixtures.

**Road:** Any road, whether public or private, that includes any street, square, court, alley, lane, bridge, footway, track, path, passage, railway trial or other highway whether a thoroughfare or not.

**Running Bond:** Construction technique for laying block work where the joints are staggered half the length of a masonry unit.

**Running Trap:** A trap installed before the discharge of the *building sewer* into the cesspit or sewer main.

**Septic tank:** A tank that receives waste material and partially treats sewage through processes of sedimentation, flotation and bacterial action so as to separate solids from the liquid, and then discharges the liquid to an approved disposal system.

**Sewage:** Liquid waste that contains fecal matter.

**Shall:** A term, when used in the code, is constructed as mandatory.

**Should:** A term, when used in the code, means a recommended practice.

**Slope (also fall or pitch):** The fall of a line in reference to a horizontal plane.

**Smoke Alarm:** An *approved*, listed assembly incorporating the detector, control equipment and the alarm sounding device in one unit.

**Smoke Chamber:** The space inside a fireplace chimney formed by the gathering, the throat and the smoke shelf.

**Smoke Shelf:** A ledge across the back of a fireplace smoke chamber which is curved upwards to reflect down draught from wind gusts back up the flue.

**Soil Pipe:** The sanitary pipe work that carries away soil water to the building sewer.

**Soil Water:** Water that contains fecal matter.

**Spa or Hot Tub:** A hydromassage pool, or tub for recreational or therapeutic use, designed for immersion of users, and usually having a filter, heater and motor driven blower. Generally a spa or hot tub is not designed to have its contents drained or discharge after each use.

**Spa or Hot Tub, Packaged Assembly:** A factory fabricated unit consisting of water-circulating, heating and control equipment mounted on a common base, intended to operate as a spa or hot tub. Equipment may include pumps, air blowers, heaters, lights, controls, etc.

**Span:** The distance between the centers of the supports of structural members such as beams, rafters and joists.

**Stack Pipe:** The vertical pipe which takes discharge from the parts of a building above ground down to the *building sewer*.

**Stack Vent:** A drainage stack carried through the roof for the purpose of venting.

**Stairway:** One or more flights of stairs and the necessary landings connecting them, to form a continuous and uninterrupted passage from one floor to another.

**Stirrups:** Reinforcement bars that bind around the main bars in beam, forming a cage.

**Storey:** That portion of a building between the upper surface of a floor and upper surface of the floor or roof above.

**Stringer:** A timber member fastened to a wall to carry vertical loads.

**Structure:** Anything that is built or constructed.

**Swimming Pool:** Any structure intended for swimming or recreational bathing that is capable of containing water of 24" deep or greater. This includes in-ground, aboveground and on-ground swimming pools, hot tubs and spas.

**Swimming Pool, Indoor:** A swimming pool which is contained within a roofed structure and surrounded on all four sides by fully closable walls of the structure.

**Throat:** The narrowing of a fireplace chimney to reduce pressure in the smoke chamber.

**Trap dip:** The top of the low point of the trap.

**Trap seal:** The vertical distance between the weir and the top of the dip of the trap.

**Trap weir:** The level that corresponds to the water seal on the outlet side of the trap.

**Trap:** A fitting or device which provides a liquid seal to prevent the escape of sewer gases.

**Trimmed (curtailed) joist:** A floor joist that has been cut short at the location of a hole and is supported by a header joist.

**Trimming Joists:** A full length floor joist adjacent to a rectangular hole in a wooden floor that runs parallel to the other floor joists. It supports the header joists.

**Unloaded Edge:** When a timber member is loaded perpendicular to the grain, the unloaded edge is defined as the edge of the timber opposite the direction in which the load is acting.

**Unloaded End:** When a timber member is loaded parallel to the grain, the unloaded end is defined as the end opposite the direction in which the load is acting.

**Unsafe:** A building or structure or part thereof that is deemed to pose a hazard to public safety or welfare by the *Building Official*.

**Vapour Barrier:** A layer of impervious material, often polyethylene sheet, to prevent condensation and ingress of moisture.

**Vent Stack:** A vertical pipe installed to provide circulation of air to and from drainage which extends through one or more stories. It carries no drainage.

**Vent System:** A pipe or pipes installed to provide a flow of air to or from a drainage system, or to provide a circulation of air within such system to protect trap seals from siphonage or back pressure.

**Vent Terminal:** End of vent pipe to a drainage system above the level of the roof of the building.

**Ventilation:** The natural or mechanical process of supplying air to, or removing it from any space.

**Wall plate:** A horizontal piece of timber along the top of a wall at eaves level that supports the rafters and/or joists.

**Waste Stack:** A vertical pipe for carrying waste water.

**Waste Water:** Water from sinks or washing not containing soil water (fecal matter).

**Water Closet:** A toilet fixture.

**Water Service Pipe:** The outside pipe from the water main or water supply to the distribution system inside the building, terminating at the service valve.

**Wet Vent:** A vent which also receives the discharge of wastes from other fixtures.

**Winder:** A circular curve in a stair used to form a bend in a flight of stairs.

### 3.5 ABBREVIATIONS AND SYMBOLS

The following abbreviations are used in the code. Where terms are not defined in this chapter, such terms shall have the ordinarily accepted meanings such as the context implies.

ABBREVIATION AND SYMBOLS	
'	Feet
"	Inches
°F	Degrees Fahrenheit
ACI	American Concrete Institute
ASCE	American Society of Civil Engineers
ASTM	American Society for Testing and Materials
BOCA	Building Officials & Code Administrators Inc.
C	Degrees Celsius
c/c	Centre to Centre or on-centre
CCA	Chromated Copper Arsenate
cfm	Cubic feet per minute
CVPC	Chlorinated Polyvinyl Chloride pipe
d	Pennyweight designation for nails
dBA	Decibels
DFU	Drainage Fixture Unit
DOT	U.S. Department of Transportation
ENT	Electrical Non Metallic Tubing
ft	Foot
ft <sup>2</sup>	Square feet
ft <sup>3</sup>	Cubic feet
GFCI	Ground fault circuit interrupter
H	Height of roof from top of wall plate to top of ridge
ICC	International Code Council, Inc.
in <sup>2</sup>	Square inches
ksi	Kips per square inch
lb	Pounds
lb/ft <sup>2</sup>	Pounds per square foot
LPG	Liquefied Petroleum Gas
mil	One thousandth of an inch
mg	milligrams
mm	millimetres
mph	Miles per hour
N/A	Not Applicable
N/mm <sup>2</sup>	Newtons per millimetre squared
NEC	National Electric Code
NFPA	National Fire Protection Association
PB	Polybutylene pipe
PSI	Pounds per square inch
PVC	Polyvinyl chloride
sq	Square
sq ft	Square feet
sq in	Square inches
T	A high yield deformed reinforcing bare of the stated diameter in millimetres
UL	Underwriters Laboratory of Canada
X	Times

**3.6 CONVERSION FACTORS**

To convert	To	Multiply by;
acres	hectares	0.4047
acres	Square feet	43564
acres	Perches	160
C	°F	1.8xC +32
chain	Yards	22
chain	Feet	66
cubic feet	Imperial gallons	6.25
cubic feet	US gallons	7.50
feet	metres	0.3048
footcandles	lux	10.76
hectares	acres	2.471
imperial gallons	US gallons	1.201
imperial gallons	liters	4.546
imperial gallons	cubic feet	0.160
inches	milligrams	25.4
kilograms	lbs	2.205
kiloNewtons	lbs	224
kips	lbs	1000
kN/m <sup>2</sup>	lbs/sq ft	20.89
knots	miles per hour	1.152
lbs	milligrams	454
lbs/ft <sup>2</sup>	N/m <sup>2</sup>	47.88
lb/ft <sup>3</sup>	N/m <sup>3</sup>	157.1
lbs	Newtons(N)	4.448
lbs/sq ft	kilopascals(kN/m <sup>2</sup> )	0.0479
lux	footcandles	0.093
metres	feet	3.281
mil	millimeters	0.0254
miles per hour	kilometers per hour	1.609
milligrams	lbs	0.002205
millimeters	inches	0.03937
pascals (N/m <sup>2</sup> )	lbs/sq in (psi)	145
perches	acres	0.00625
square kilometers	acres	247.1
square kilometers	hectares	100
square feet	square inches	144
square miles	acres	639.7
square miles	hectares	258.9
tonne	lbs	2205
tons (short)	lbs	2000
US gallons	Imperial gallons	0.8327
US gallons	litres	3.785
US gallons	cubic feet	0.1333
yards	feet	3
yards	metres	0.9144

## 4 BUILDING LAYOUT

### 4.1 GENERAL

The location, height and nature of the buildings on the site shall comply with the requirements of the current Development and Planning Act, Planning Statement and Development Plan.

### 4.2 ROOM SIZES

Every *dwelling unit* shall have at least one *habitable room* which shall have not less than 150 sq-ft. of floor area. *Other habitable rooms*, except kitchens shall have not less than 70 sq-ft. of floor area. Every kitchen shall have no less than 50 sq-ft. of floor area. *Habitable rooms* except kitchens shall be not less than 7 feet in width in any horizontal dimension. Kitchens shall have a minimum dimension of 5 feet in width.

### 4.3 CEILING HEIGHTS

#### 4.3.1 HABITABLE ROOMS

All *habitable* rooms other than kitchens shall have a ceiling height of not less than 7'-6".

#### 4.3.2 ANCILLARY ROOMS

Ancillary rooms and kitchens shall have a ceiling height of not less than 7 feet.

#### 4.3.3 SLOPING CEILINGS

Not more than 50% of the required area specified in Section 4.2 may have a sloped ceiling less than the required height with no portion of the required area less than 5' in height.

#### 4.3.4 PROTRUSIONS INTO CEILING HEIGHT

Beams and girders spaced not less than 4 feet on centre may project not more than 6" below the required ceiling height.

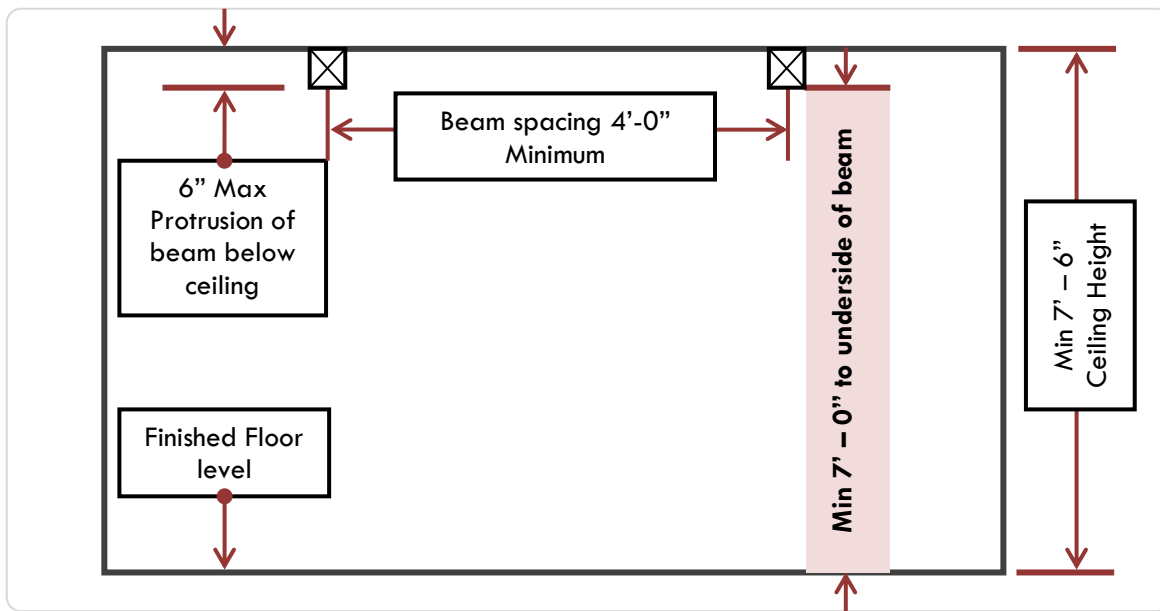

Figure 4-1 – Ceiling Heights

## 4.4 STAIRWAYS

### 4.4.1 WIDTH

Stairways shall be not less than 36" in clear width at all points above the permitted handrails height and below the required headroom height. The minimum width at and below the handrail shall be not less than 32" where a handrail is installed on one side or 28" where a handrail is installed on both sides.

Exception: Stairways that do not form part of a means of egress from the building may be reduced to a minimum of 30" in width.

### 4.4.2 HEADROOM

The minimum headroom in all parts at the stairway shall be not less than 6'6" measured vertically from the sloped plane adjoining the tread nosing or from the floor surface of the landing or platform.

Exception: Where existing conditions are such that due to space constraints the creation of this headroom is deemed impractical by the Building Official, the minimum headroom requirement may be reduced to 6'-4".

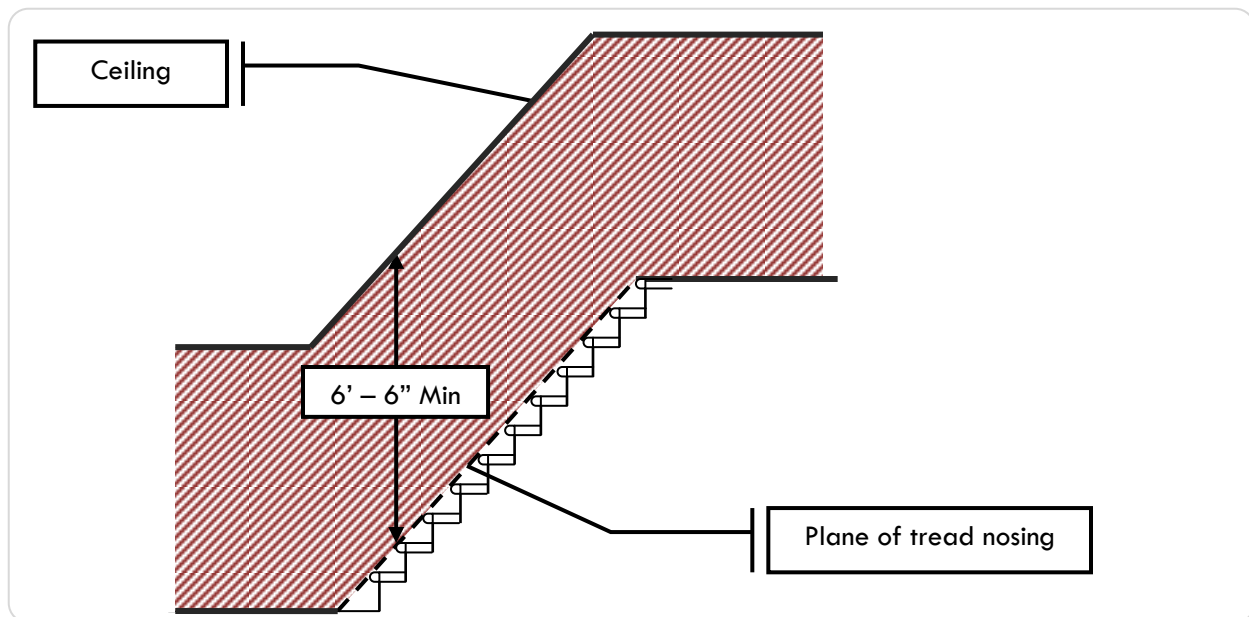

Figure 4-2 - Stairway Headroom Requirements

### 4.4.3 TREADS AND RISERS

The maximum riser height shall be 7 <sup>3</sup>/<sub>4</sub> inches and the minimum tread depth shall be 10 inches. The minimum riser height shall be 4". The riser shall be measured vertically between leading edges of the adjacent treads. The tread depth shall be measured horizontally between the vertical planes of the foremost projections of adjacent treads and at a right angle to the tread's leading edge. The walking surface of treads and landings of a stairway shall be sloped no steeper than one unit vertical in 48 units horizontal (2-percent slope). The greatest riser height within any flight of stairs shall not exceed the smallest by more than <sup>3</sup>/<sub>8</sub> inch. The greatest tread depth within any flight of



stairs shall not exceed the smallest by more than  $\frac{3}{8}$  inch. The maximum nosing on the stairs shall be  $1\frac{1}{4}$ ".

#### 4.4.4 LANDINGS

The maximum vertical rise of stairs between landings shall be 12 feet. The minimum size of landings shall be 36"x36". Landings shall be provided either side of exit doors and at the top of all other exterior stairs leading to a building where there are more than 3 risers. The maximum step from the interior floor level to an exterior landing shall be  $7\frac{3}{4}$ ".

#### 4.4.5 WINDERS CIRCULAR STAIRS

These are permitted, provided that the width of the tread at a point not more than 12 inches from the side where the treads are narrower is not less than 10 inches and the minimum width of any tread is not less than 6 inches. The smaller radius of circular stairs shall be not less than twice the width of the stairway.

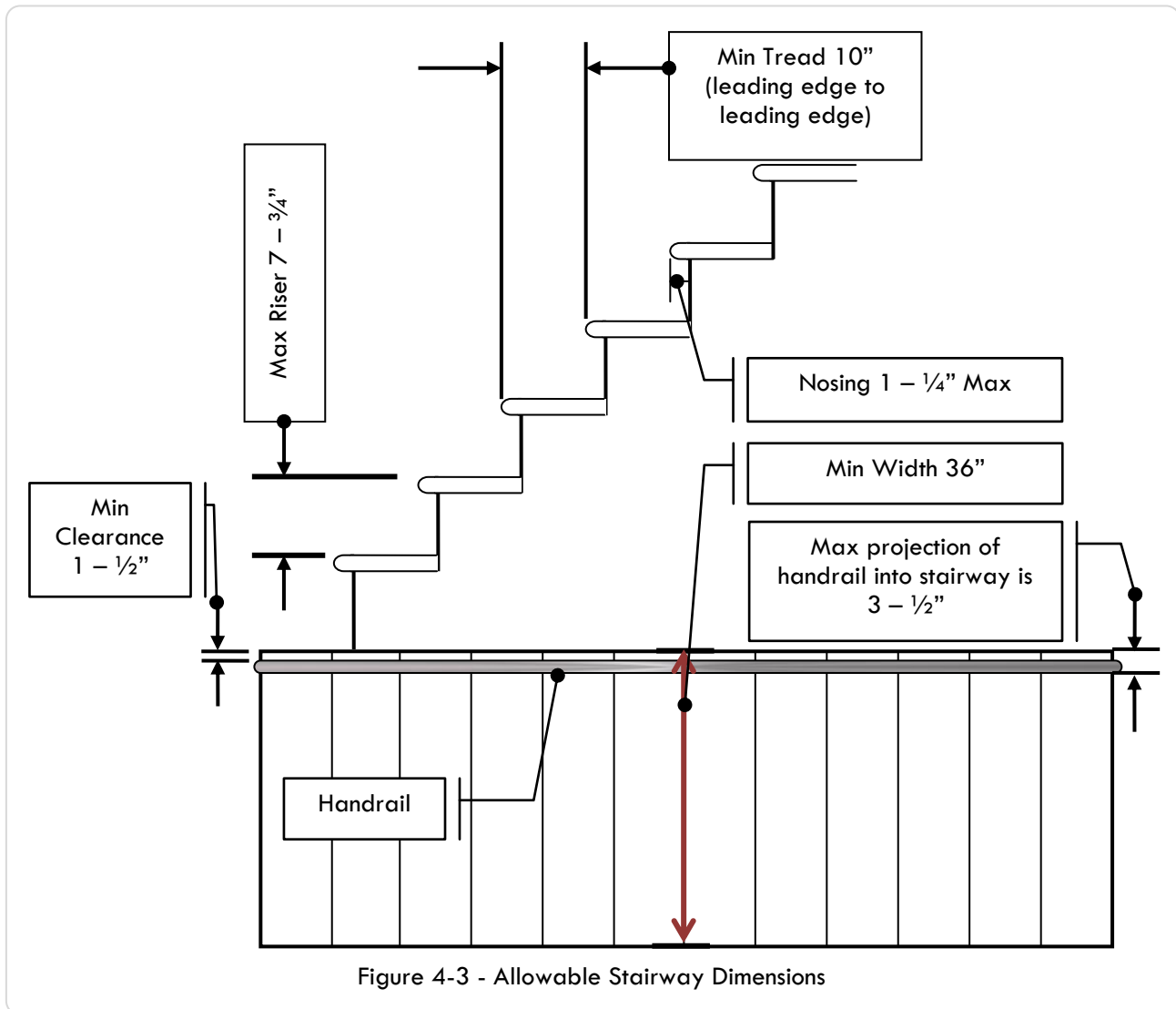

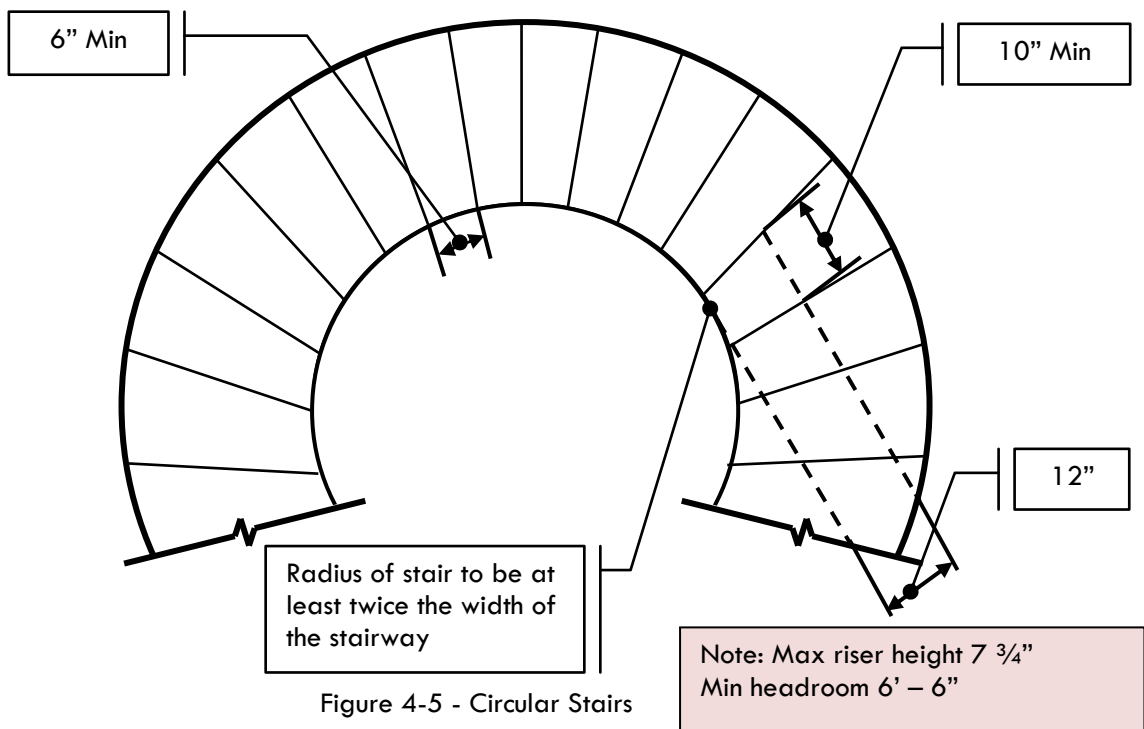
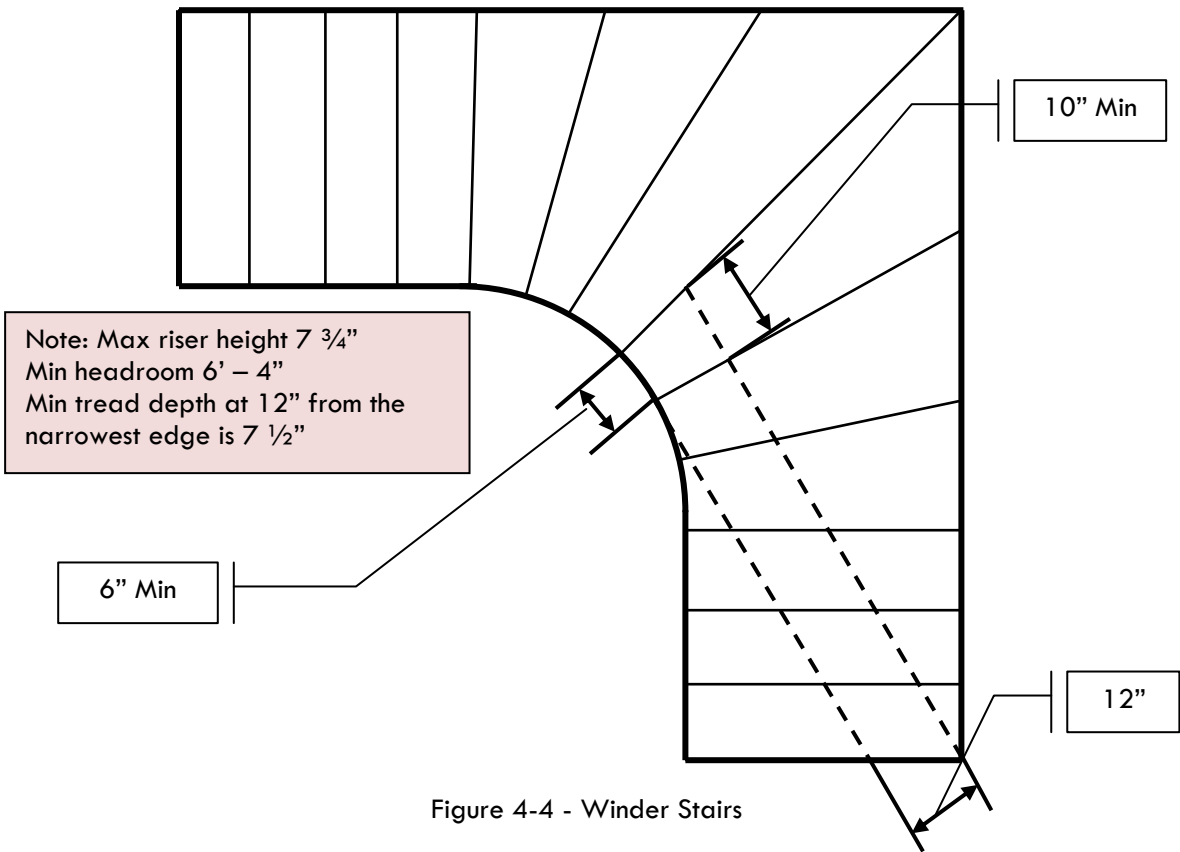

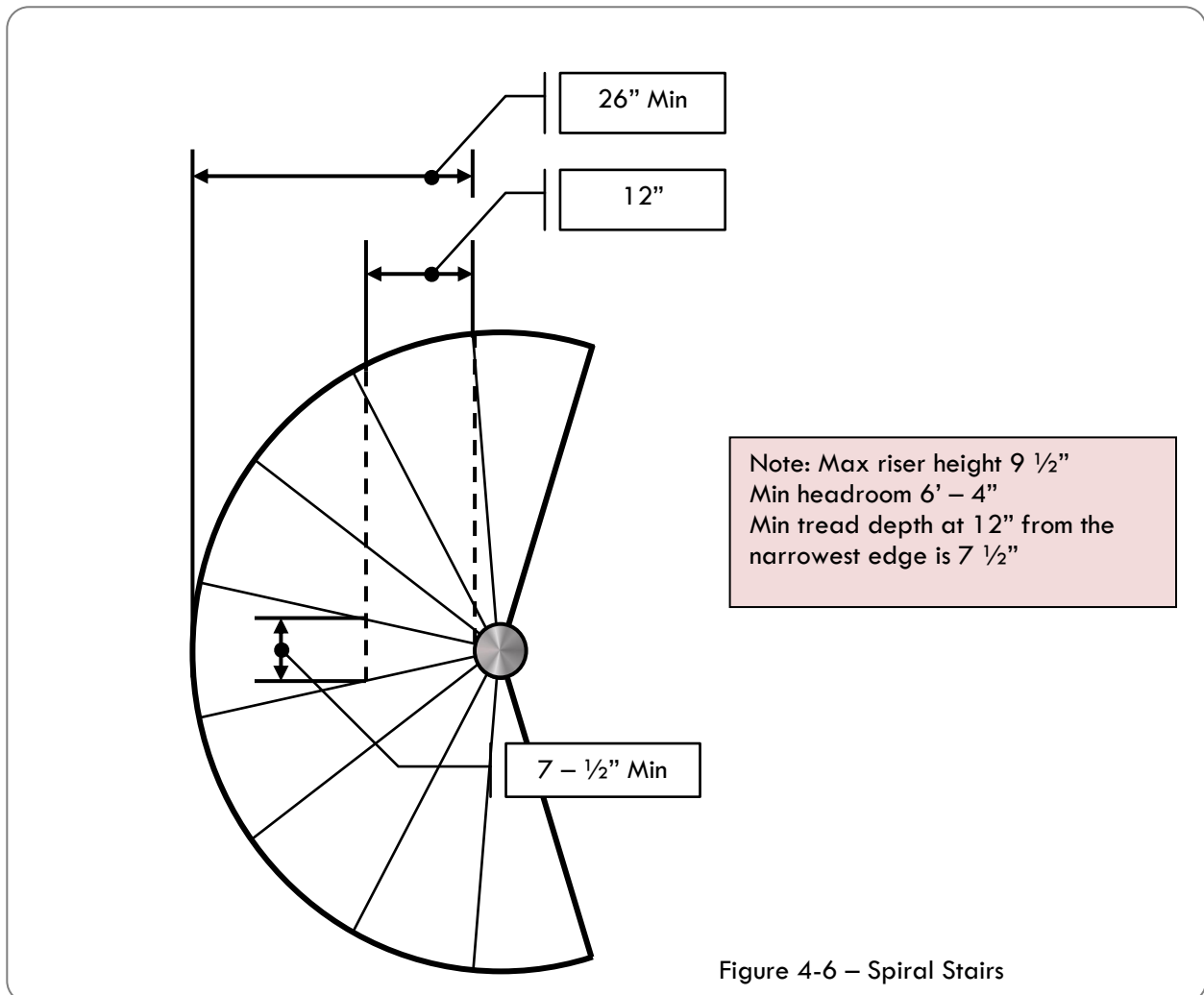

#### 4.4.6 **SPIRAL STAIRS**

Spiral stairways are permitted, provided the minimum tread width shall be 26 inches with each tread having a 7 ½ inch minimum tread depth at 12 inches from the narrow edge. All treads shall be identical, and rise shall be no more than 9 ½ inches. Minimum headroom of 6'-6" shall be provided.

#### 4.4.7 **ILLUMINATION**

All stairs shall be provided with illumination in accordance with section 4.10.6

#### 4.5 **HANDRAILS**

##### 4.5.1 **GENERAL**

Handrails shall be provided on at least one side of stairways of 3 or more risers for interior stairs and exterior stairs that form part of the means of egress from the building. Other exterior stairs shall have handrails provided where the total rise of the stairway exceeds 4 feet between landings

that comply with section 4.4.4. Spiral staircases shall have the required handrail located on the outside radius. Handrails shall be continuous for the full length of the stair.

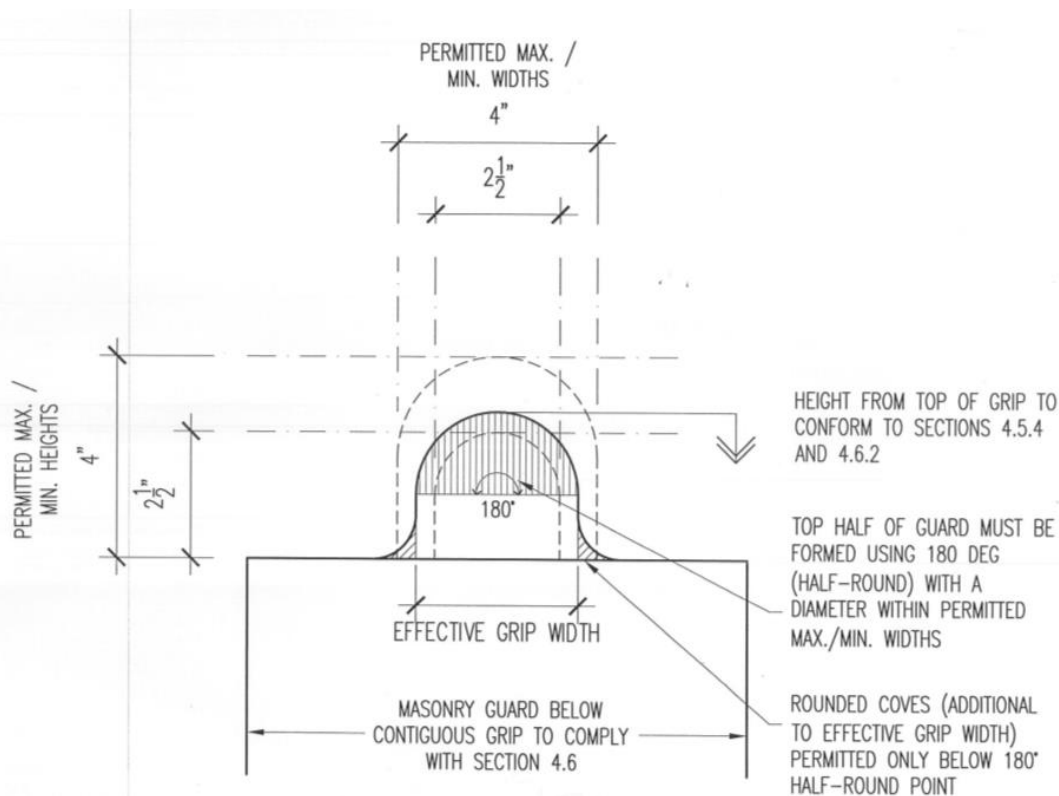

Figure 4-7 – Masonry-formed continuous grip handrail

#### 4.5.2 CLEARANCE

The clear space between the handrail and the adjacent wall surface shall not be less than 1 ½".

#### 4.5.3 GRIP SIZE

The handrails shall have a circular cross section not greater than 2" or less than 1 ¼", or any shape with the largest cross-sectional dimension not exceeding 2 ¼".

#### 4.5.4 MASONRY-FORMED HANDRAIL

The masonry-formed handrails shall have a circular cross section not greater than 4" or less than 2 ½", or any shape with the largest cross-sectional dimension not exceeding 2 ¼".

#### 4.5.5 HEIGHT

Handrails shall be neither less than 30" nor more than 38" measured vertically above the leading edge of the tread or the walking surface of the landing. Handrails that form part of a guard shall be in accordance with section 4.6.

#### 4.5.6 LOADINGS

All handrails shall be designed for a 200 lb concentrated load applied at any point and in any direction.

## 4.6 GUARDRAILS

### 4.6.1 GENERAL

Porches, balconies, raised floor surfaces, landings, or open sides of stairs where the raised floor surface is greater than 30" above the floor below shall be equipped with guards. In addition, guards in exterior situations shall be installed in accordance with section 5.6.1.

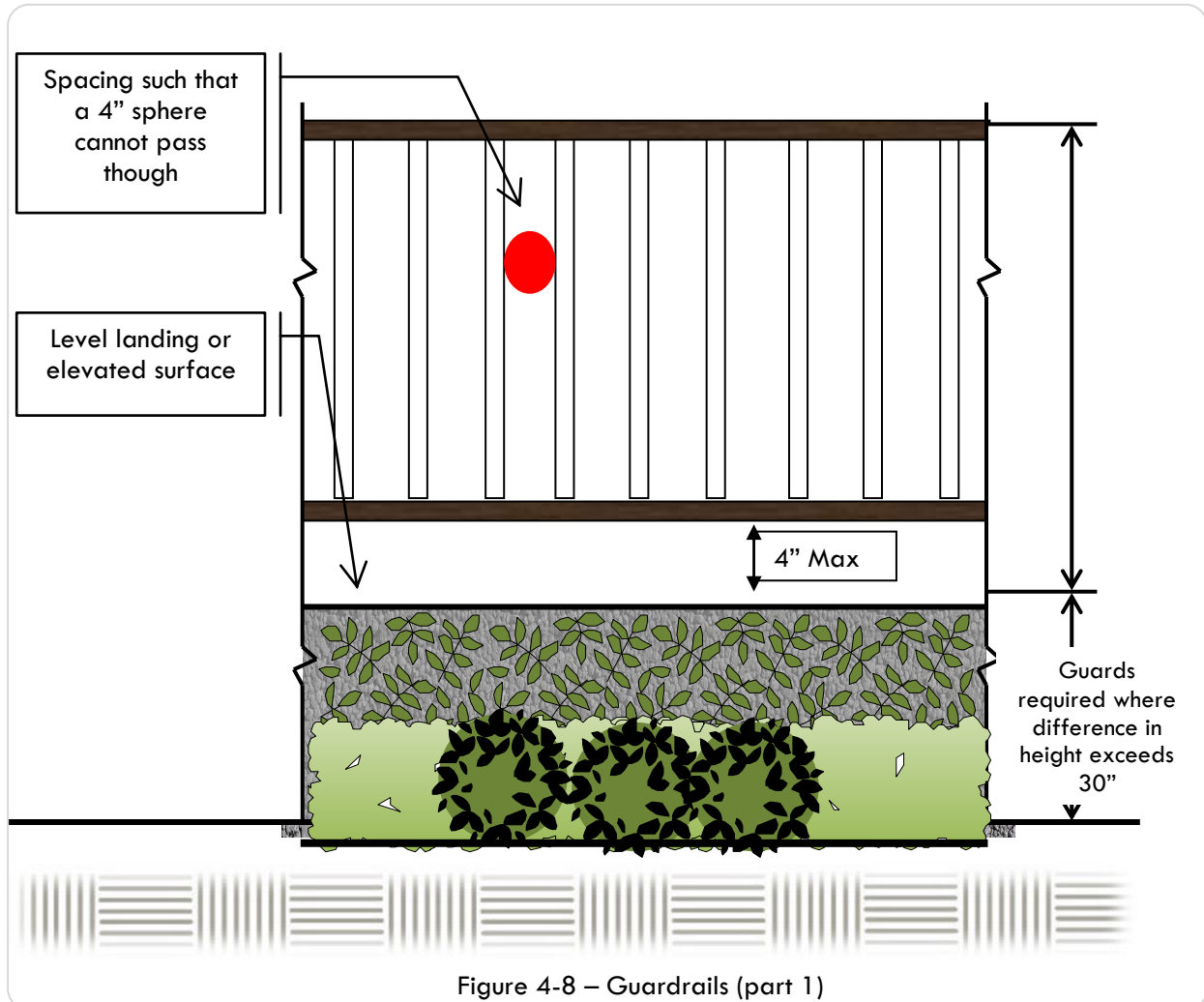

### 4.6.2 HEIGHT

Guardrails shall be not less than 36" above the adjacent surface.

Exception: Open sides of stairs shall have guardrails not less than 34" in height measured vertically above the nosing of the tread.

### 4.6.3 OPENINGS

Guardrails shall be so constructed that a sphere with a diameter of 4" cannot pass through it at any point. This includes the triangular openings formed by the riser, the tread and the bottom rail. Guards shall not be constructed so that a ladder effect is produced that would enable a person to climb up it.

**Exception:** Where an addition to an existing building is planned and the designer wishes to match the existing guardrails conditions, the *Building Official* may, at their discretion, make an exception to the guardrail opening requirements.

#### 4.6.4 LOADINGS

All guardrails shall be designed for the worst case of a 200 lb concentrated load applied at any point and in any directions or a 200 lb/ft uniform load applied at the top of the assembly. Infill areas shall be designed for a horizontal concentrated load of 200 pounds applied on a 1 square foot area at any point in the system.

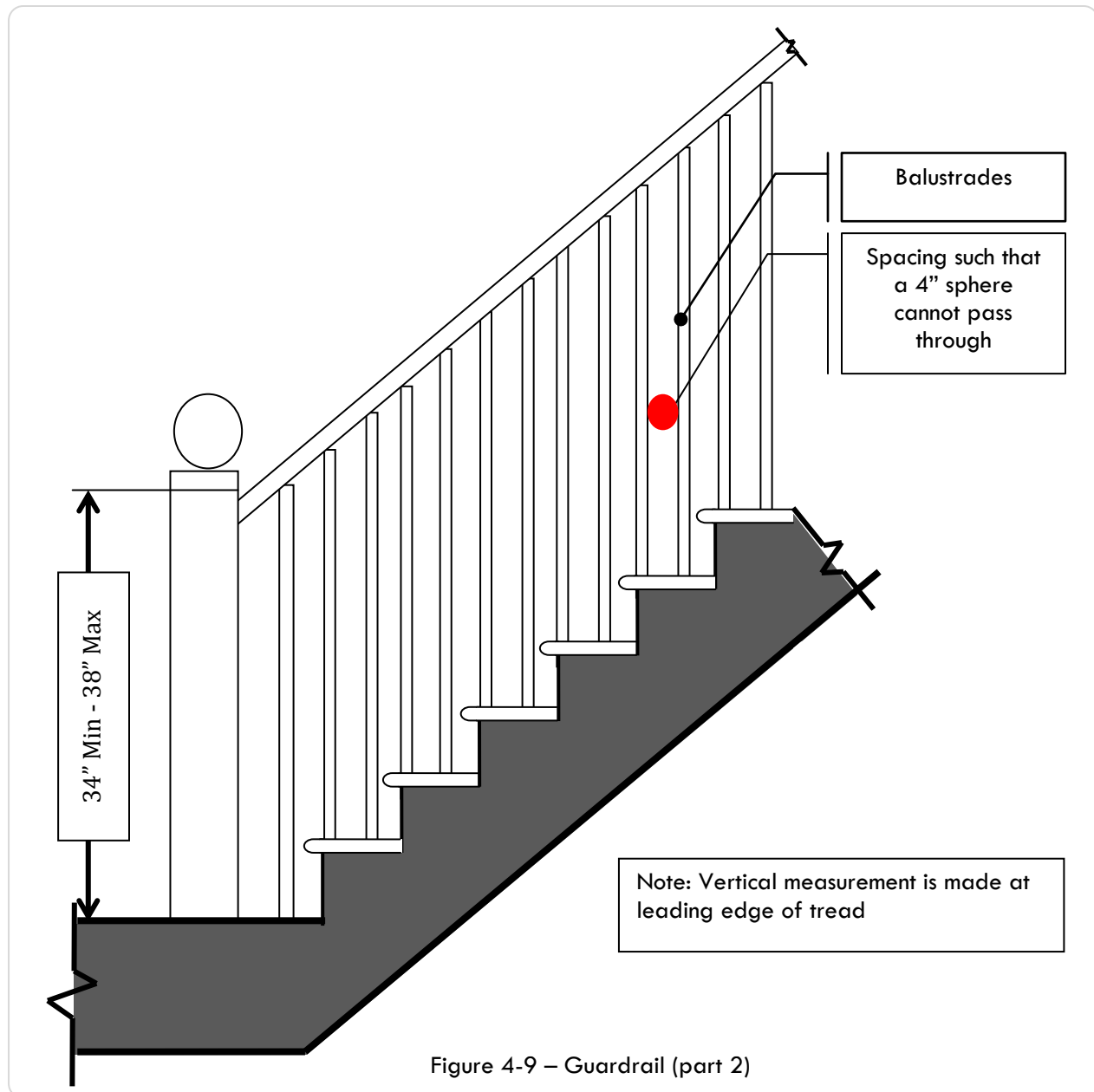

## **4.7 EXITS**

### **4.7.1 GENERAL**

At least one exit complying with this chapter shall be provided for each dwelling unit.

### **4.7.2 EXIT DOORS & HALLWAYS**

At least one exit door shall be provided per dwelling unit and it shall open directly to a safe outdoor area. The exit door shall not be shared with any other dwelling unit. The required exit door shall be a side-hinged door or an approved sliding door not less than 32 inches in width and 6'-8" in height. Other exterior hinged or sliding doors shall not be required to comply with these minimum dimensions and may be reduced to the standards specified in section 4.8. The minimum width of a hallway or exit access leading to the exit door shall be not less than 3 feet.

### **4.7.3 DOOR HARDWARE**

Door handles, pulls, latches, locks and other operating devices shall be at a maximum height of 48 inches above the finished floor. The operating devices shall be capable of operation with one hand.

### **4.7.4 LOCKS AND LATCHES**

All exit doors shall be readily openable from the inside without the use of a key or special knowledge or effort. All exit doors shall require no more than two separate actions to open them.

#### **Exception:**

1. Key operation shall be permitted from an exit door provided that the key cannot be removed from the lock when the door is locked.
2. Exit doors shall be permitted to be equipped with a night latch, dead bolt or security chain, provided that such devices are openable from the inside without the use of a key or tool and are mounted at a height not to exceed 48 inches above the finished floor. Electronic mechanisms may be installed that meet the exit requirements for egress.

### **4.7.5 WINDOW WELL**

An emergency and rescue opening with a finished sill height below the adjacent ground level shall be provided with a window well in accordance with sections 4.7.5.1 through 4.7.5.3.

### **4.7.6 MINIMUM SIZE**

The minimum horizontal area of the window well shall be 9 sq-ft, with a minimum dimension of 36 inches. The area of the window well shall allow the emergency escape and rescue opening to be fully opened.

### **4.7.7 LADDERS OR STEPS**

Window wells with a vertical depth of more than 44 inches shall be equipped with an approved permanently affixed ladder or steps. Ladders or rungs shall have an inside width of at least 12 inches, shall not project not more than 18 inches on center (o.c.) vertically for the full height of the window well. The ladder or steps shall not encroach into the required dimensions of the window well by more than 6 inches. The ladder or steps shall not be obstructed by the emergency escape and rescue opening.

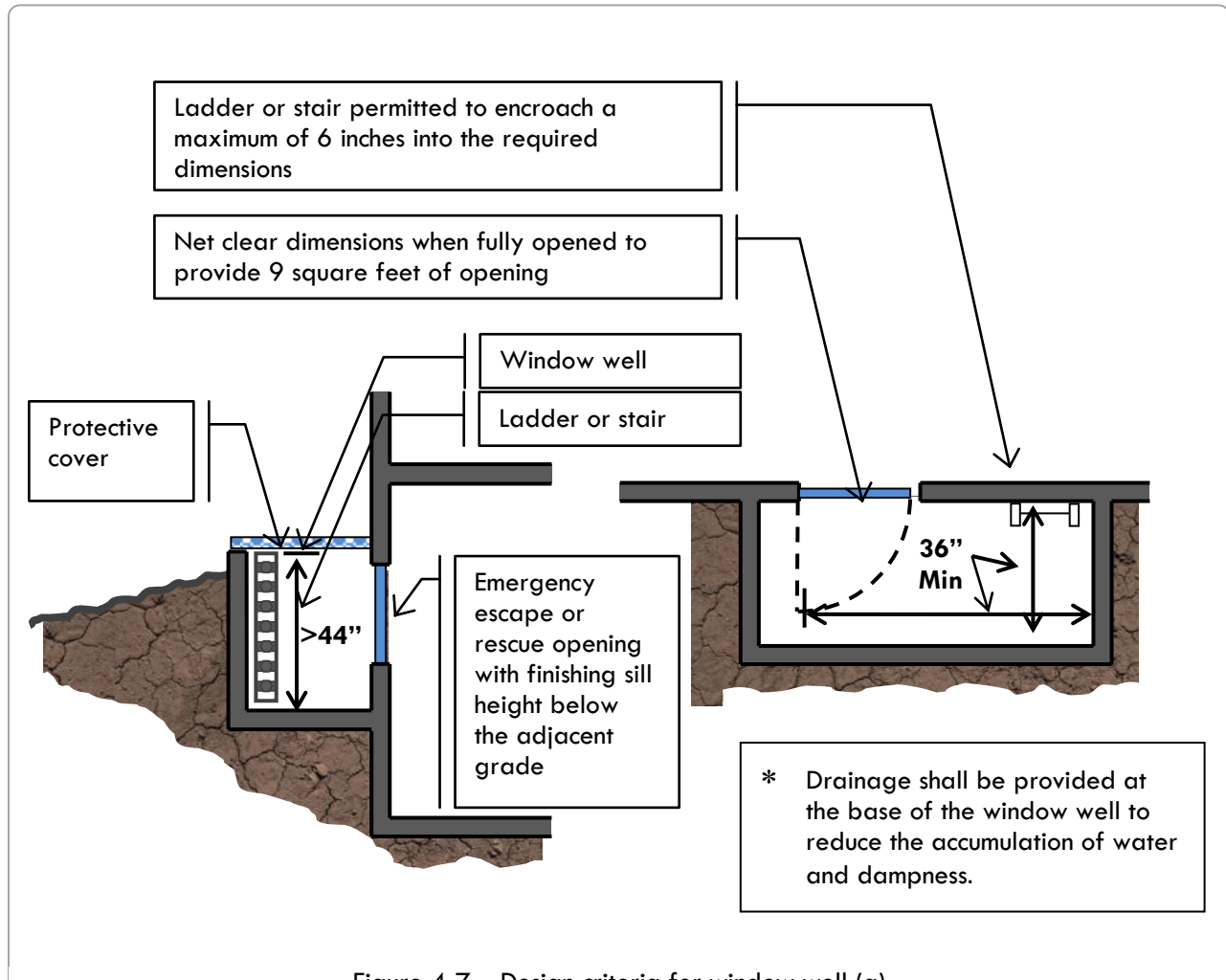

Figure 4-7 – Design criteria for window well (a)

#### 4.7.8 BARS, GRILLS, COVERS, SCREENS

Bars, grills, covers, screens or similar devices are permitted to be placed over emergency escape and rescue openings or window wells that serve such openings provided the minimum net clear opening size complies with IRC-R310 and is removable from the inside without the use of a key, tool, special knowledge or force greater than that which is required for normal operation of the escape and rescue opening.



**Design criteria:**

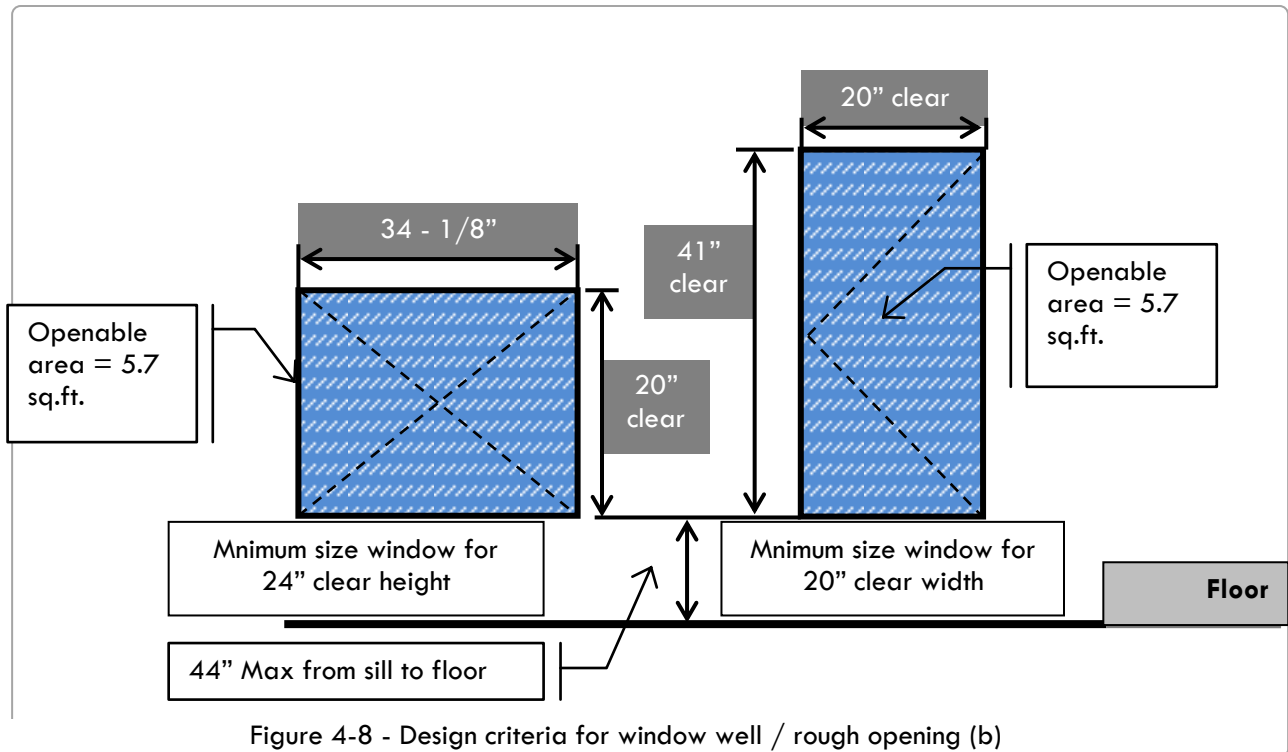
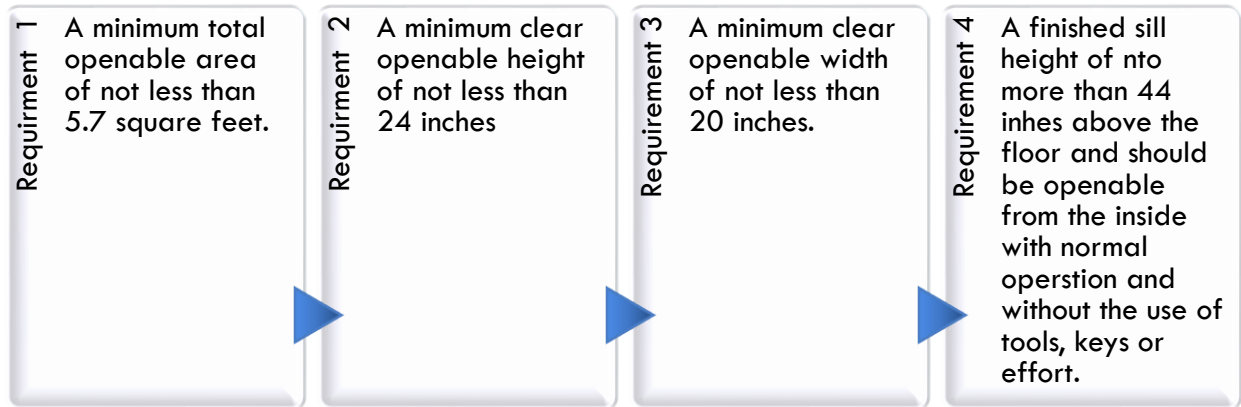

Figure 4-8 - Design criteria for window well / rough opening (b)

**4.7.9 EMERGENCY EGRESS**

**4.7.9.1 EACH ROOM**

Every sleeping room shall have a second means of egress consisting of at least one operable window or exterior door approved for emergency egress or rescue. The units must be operable from the inside to a full clear opening without the use of a key or tool. Where windows are provided as a means of egress or rescue they shall have a sill height of not more than 44 inches above the floor.

**4.7.9.2 MINIMUM SIZE**

All egress or rescue windows from sleeping rooms shall have a minimum net clear opening height of 24 inches and a minimum net clear opening width of 20 inches.

**4.7.9.3 BARS, GRILLS AND SCREENS**

Bars, grills, screens or other obstructions placed over emergency escape windows shall be releasable or removable from the inside without the use of a key or tool.

**4.8 DOORS****4.8.1 DIMENSIONS**

The minimum width of doors shall be not less than 28" unless they are an exit door as described in section 4.7.2. The height of doors shall be not less than 6'-6". Door openings to storage closets and into other spaces that are not habitable or ancillary rooms within a dwelling unit shall not be limited to the minimum height and width requirements.

**4.8.2 DOOR HARDWARE**

Door handles, pulls, latches, locks and other operating devices shall be at a maximum height of 48 inches above the finished floor. All means of egress doors shall be of a side-swinging type or approved sliding doors and comply with section 4.7.2.

**4.8.3 CLOSET DOORS**

Every closet door shall be such that children can open the door from inside the closet.

**4.8.4 BATHROOM DOORS**

Every bathroom door shall be designed to allow opening from the outside in case of an emergency when locked.

**4.9 SANITATION****4.9.1 SANITARY FACILITIES**

Every *dwelling unit* shall be provided with potable running water, at least one water closet, lavatory, and a bath or a shower.

**4.9.2 PRIVACY**

Every water closet, bath and shower shall be installed in a room which will afford privacy to the occupant.

**4.9.3 KITCHEN**

Each *dwelling unit* shall be provided with a kitchen area and every kitchen area shall be provided with a sink of *approved* non-absorbent material.

**4.9.4 ACCESS TO FIXTURES**

Plumbing and drainage fixtures shall be installed so as to afford easy access for cleaning both the fixture and the area around the fixture.

#### **4.9.5 COMMUNAL TRASH CONTAINERS**

Where there are three or more apartments on a single lot, a communal trash container shall be provided in accordance with the current development plan.

#### **4.9.6 SETTING & INSTALLATION**

##### **4.9.6.1 WATER CLOSETS**

A water closet shall not be set closer than 15" from its centre to any side wall, partition or other obstruction. There shall be at least 15" clearance in front of the water closet to any wall, fixture or door. Water closet compartments shall be not less than 30" wide and 60" deep.

##### **4.9.6.2 SHOWERS**

All shower compartments shall have a minimum of 900 sq. inches (6.25 sq ft) and the minimum dimension shall be not less than 30", measured from the interior of the shower exclusive of fixture valves, shower heads, soap dishes and safety grab bars.

#### **4.10 LIGHTING**

##### **4.10.1 GENERAL**

The lighting of all *habitable rooms* shall be adequate to provide an average illumination of 10 foot candles over the area of the room at a height of 30" above the floor level. *Ancillary rooms* shall be provided with lighting adequate to provide an average illumination of 3 foot candles over the area of the room measured at a height of 30" above the floor level. For emergency purposes only, 6' candles will be required.

##### **4.10.2 MINIMUM GLAZING AREA**

The minimum glazing area for rooms within *dwelling units* shall conform to Table 4.1. Every *habitable room* or space intended for human occupancy shall have an exterior glazing area of not less than 8% of the floor area and 4% natural ventilation. Natural light shall be provided by glazing areas that open onto courts or yards or by other *approved* means.

Bedrooms formed in basements must conform to the requirements as far as practicable. Any proposed deviation may be granted at the discretion of the *Building Official*.

##### **4.10.3 ADJOINING SPACES**

Where natural light for rooms or spaces without exterior glazing areas is provided through an adjoining room, the unobstructed opening to the adjoining room shall be at least 8 percent of the floor area of the interior room or space, but not less than 25 square feet. The exterior glazing area shall be based on the total floor area being served.

Location	General Provision	With minimum acceptable electric lighting
Living rooms, Dining rooms, Bedrooms	8% of floor area	8% of floor area
Kitchen	8% of floor area	Windows not required
Bathrooms, W.C room	2 sq ft	Windows not required
Laundry, Basement, Recreation room	4% of floor area	Windows not required

**Note:**

1) Where windows are not provided, mechanical ventilation in accordance with section 20.2 shall also be provided.

2) Electric lighting shall be in accordance with section 4.10.1

**Table 4.1 - Minimum Glazing Areas for Residential Rooms**

#### **4.10.4 HALLWAYS**

Natural light should be capable of penetrating the full length of the hallway. Any room that opens into the hallway shall have 3-way switch or multi switching and hallways that are over 6 feet must have at least 2 switches.

Internal Hallways with no external wall access to daylight could gain natural light from the use of skylights or solar reflectors in the form of mirrored tubes (sun tube lights).

##### **4.10.4.1 BUILDING PERMIT/REGULATIONS FOR SUN TUBE LIGHTS**

All applications for sun tube lights will have to be furnished with the specifications and installation requirements from the manufacturer of choice.

#### **4.10.5 BATHROOM / TOILET ROOM LIGHTING**

A *bathroom* should wherever possible be situated on an external wall and be provided with a window not less than 2 sq. ft. in area. Every *bathroom* and toilet room shall also be provided with artificial light. The illumination shall have an average intensity of 3 foot candles measured at a height of 30" above the floor.

#### **4.10.6 STAIRWAY ILLUMINATION**

All stairways and internal ramps within *dwelling units* shall be provided with a minimum illumination level of 10 foot candles measured at every tread nosing. Exterior stairways serving a dwelling unit shall have an illumination level on tread runs of 1 foot candle.

##### **4.10.6.1 CONTROLS**

The control for activation of the required stairway lighting within a *dwelling unit* shall be operable from the top and bottom of each stairway (by way of a 3 way switch) without traversing any step of the stair.

The illumination of an exterior stairway serving a dwelling unit shall be controlled from inside the dwelling unit, unless continuously illuminated or automatically activated. Six (6) steps or more shall be provided with lighting (artificial or natural).

**4.11 VENTILATION**

**4.11.1 GENERAL**

Natural ventilation of *habitable rooms* and garages shall be through windows, doors, louvers or other natural openings to the outside air.

**4.11.2 VENTILATION REQUIRED**

The minimum openable area shall be in accordance with Table 4.2.

Location	With minimum acceptable electric lighting
<b>Living rooms, Dining rooms, Bedrooms, Kitchen</b>	4% of floor area
<b>Garages</b>	4% of floor area
<b>Bathrooms, W.C room</b>	1 sq-ft
<b>Laundry, Basement, Recreation room</b>	2% of floor area

Note:

1) Where natural ventilation is not provided in accordance with Table 4.2, mechanical ventilation in accordance with section 20.2 shall be provided

Table 4.2 – Minimum natural ventilation areas for room

**4.11.3 ADJOINING SPACES**

Where rooms and spaces without openings to the outdoors are ventilated through an adjoining room, the unobstructed opening to the adjoining room shall be at least 8 percent of the floor area of the interior room or space, but not less than 25 square feet. The ventilation openings to the outdoors shall be based on the total floor area being ventilated.

**4.11.4 OPENINGS BELOW GRADE**

Openings below grade shall be acceptable for natural ventilation provided that the outside horizontal clear space measured perpendicular to the opening is 1½ times the depth below the average adjoining grade to the lowest point of the openable portion of the window.

**4.11.5 BATHROOMS AND TOILET ROOMS**

*Bathrooms* and toilet rooms shall be provided with a window at least 2 sq. ft. in area of which 50% is openable. Where this is not possible mechanical ventilation must provide at least 50 cubic feet per minute of outdoor ventilation air. Bathroom vents shall not discharge into kitchen parameters.

Location	Minimum openable areas
Living rooms, Dining rooms, Bedrooms, Kitchens	4% of floor area
Garages	4% of floor area
Laundry, Basement, Recreation room	2% of floor area

Note:

1) Where natural ventilation is not provided in accordance with Table 4.2, mechanical ventilation in accordance with section 20.2 shall be provided.

Table 4.3 - Minimum Natural Ventilation Areas for Rooms

**4.11.6 MECHANICAL VENTILATION**

Where natural ventilation is not possible in rooms, mechanical ventilation shall be provided as per Chapter 19.

**4.12 SOUND TRANSMISSION CONTROL****4.12.1 GENERAL**

This applies to all common interior walls, partitions and floor/ceiling assemblies between adjacent *dwelling units*.

**4.12.2 AIR-BORNE NOISE**

Walls, partitions and floor/ceiling assemblies separating *dwelling units* from each other shall have a sound transmission classification of not less than 45 for air borne noise when tested in accordance with ASTM E 90.

**4.12.3 STRUCTURE-BORNE NOISE**

Floor ceiling assemblies between dwelling units shall have an impact insulation class rating of not less than 45 when tested in accordance with ASTM E492.

**4.13 RAMPS****4.13.1 GENERAL**

Where used, ramps shall comply with the following requirements.

**4.13.2 MAXIMUM SLOPE**

Ramps shall have a maximum slope of 1 unit vertical to 8 units horizontal for a total rise up to 12". For rises above 12" the slope shall be 1 unit vertical to 12 units horizontal. The maximum slope across the direction of travel shall be 1 in 48.

**4.13.3 WIDTH**

The minimum width of a ramp shall be 36 inches.

**4.13.4 HANDRAILS**

Handrails shall be provided on at least one side of the ramp and they shall comply with the requirements of section 4.5.

**4.13.5 LANDINGS**

Landings of minimum size 36 inches by 36 inches shall be provided at the top and bottom of ramps, where doors open onto the ramp, and where the ramp changes direction.

## 5 SITEWORKS

### 5.1 PROPOSED AND EXISTING WORKS

The applicant may need to submit a site plan based on a site survey, full or partial, prepared by a registered surveyor where buildings or building operations are proposed within a setback to a lot line specified in the current development plan, as required at the discretion of the *Building Official*.

### 5.2 EXISTING SERVICES

The applicant is responsible for determining the occurrence of all existing services on the site. These include underground electricity, telephone, cable TV, water, gas and sewer lines. These shall be adequately marked out prior to any excavation taking place and shall be capped or re-routed where necessary.

Services are to be depicted on drawings following completion of installation to the satisfaction of the local utility company. Services within 5' of the setback, as specified in the current development plan, must be marked out by a registered surveyor.

### 5.3 SITE BOUNDARY

The extent of the site shall be marked out by survey stakes placed by a registered surveyor prior to the commencement of any work that is closer than 5' to the line of setback (as specified in the current development plan) or under any other circumstances deemed necessary by the Building Official.

### 5.4 SETTING OUT

All proposed excavations shall be adequately marked out by a qualified person (with spray paint or other such approved means) prior to any works commencing in order to avoid any over-excavation of the property.

### 5.5 EXISTING ROCKCUTS/RETAINING WALLS

Where the underside of the foundations for a proposed new structure is situated closer to the edge of an existing rockcut/retaining wall than the height of the rockcut/retaining wall, and thus imposes a surcharge loading on the rockcut/retaining wall, it shall be necessary to have a registered engineer check the stability of the existing rockcut / retaining wall. If deemed necessary by the *Building Official* the existing rockcut/retaining wall shall be shored up to withstand the surcharge loadings.

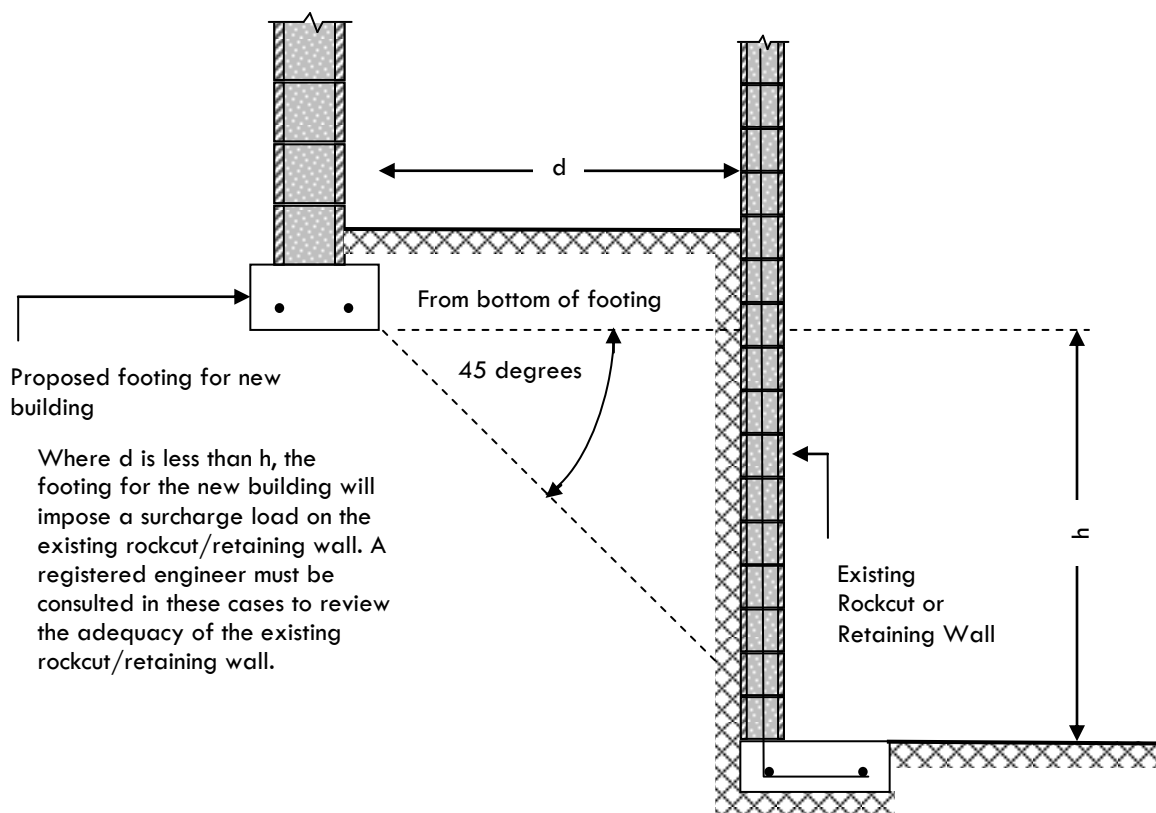
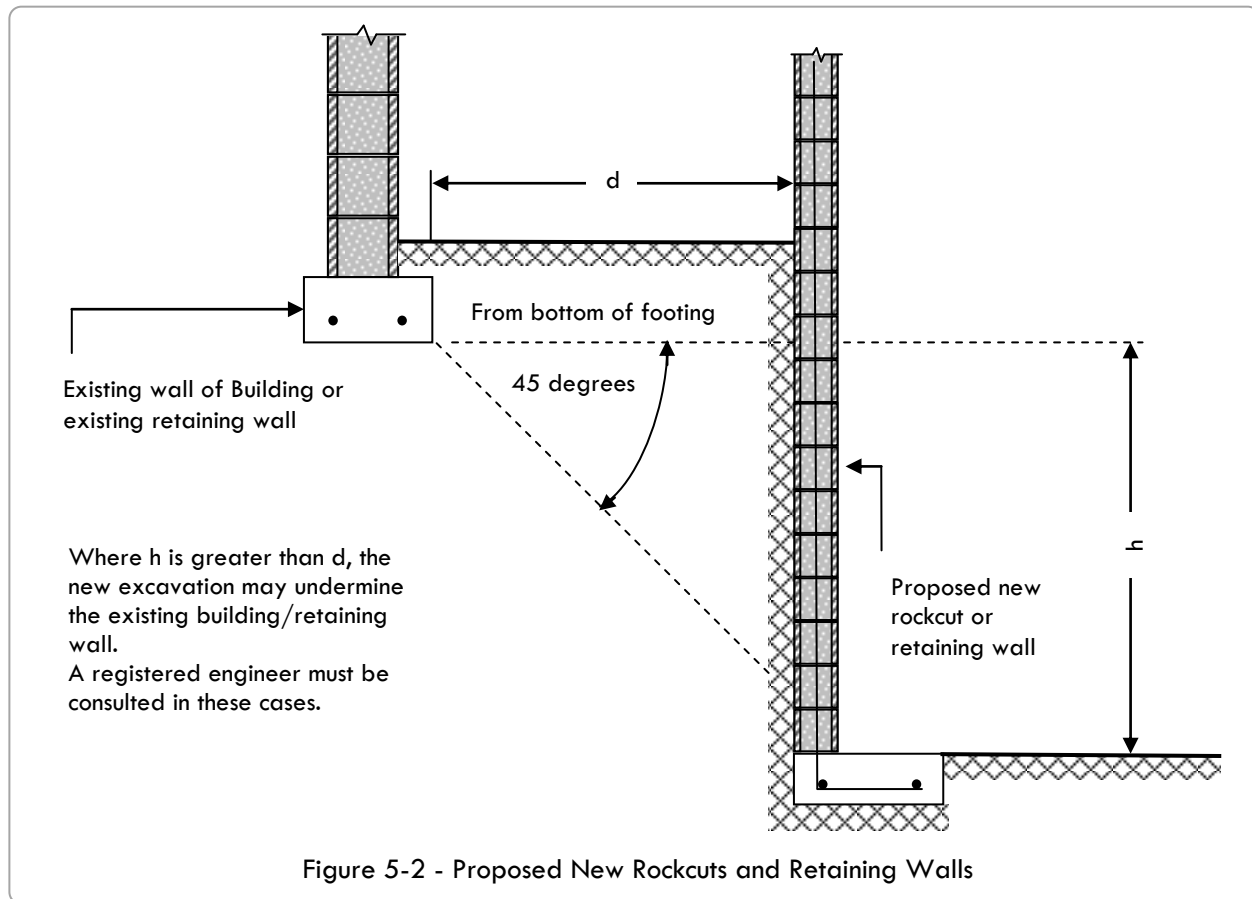

Figure 5-1 - Existing Rockcuts and Retaining Walls

## 5.6 NEW EXCAVATIONS/ROCKCUTS/RETAINING WALLS

When an excavation is to be made, the owner shall erect a retaining wall at their own expense and on their own land. Such a wall shall comply with the requirements of section 5.9 or be designed by a registered engineer and shall be suitable to adequately retain the adjacent property and any structures that are on it. Where the site is suitable to accommodate a rockcut in lieu of a retaining wall, rockcuts greater than 6 feet in height shall be certified by a registered engineer. Where rockcuts and excavations are proposed within a distance closer than the height of an existing rockcut or retaining wall, either on the owners' property or the property of an adjoining owner, a report on the possible undermining effects of the proposed new excavation shall be forwarded to the *Building Official* by a registered engineer.





### 5.6.1 GUARDRAILS

Guardrails shall be erected for all exterior retaining walls or rockcuts where the difference in grade between the upper and lower levels exceeds 4 feet above soil or sand and 30" above a hard surface. For slopes that exceed a gradient of 1 vertical to 1 horizontal where the difference in grade between the upper and lower levels exceeds 4 feet, guardrails shall also be installed. These guardrails shall be built on the owner's property. The guard system shall be erected prior to the commencement of all excavation works. The guardrail shall be in accordance with section 4.6. Alternatively a natural barrier (e.g. a dense hedge) a minimum of 3'-0" in height may be allowed at the discretion of the *Building Official*. Natural barriers can only be used up to a height of 8'. It may be necessary to erect temporary barriers while the natural barrier matures.

### 5.7 FILL

Where it is desirable to place fill on the site to raise the level then this shall be performed as follows:

#### 5.7.1 PLACING OF FILL

Fill material shall be made up of well graded natural stone free of organic soil, rubbish or vegetation. The fill shall be placed in layers not exceeding 6" thick and thoroughly consolidated by means of watering and approved mechanical compaction between each layer.

### 5.7.2 FILL SLOPES

Where fill material can be sloped off entirely on the owner's property it may be done so at a slope not exceeding 1 vertical to 3 horizontal. Such slopes should be planted with vegetation to prevent erosion and run off.

### 5.7.3 RETENTION OF FILL

Where it is desirable to retain fill on a site, or where fill is placed against a boundary where the level of the adjacent property is lower than the finished height of the fill then a retaining wall shall be built. The retaining wall shall be in accordance with section 5.9 or it shall be designed by a registered engineer.

### 5.7.4 FOUNDATIONS ON FILL

Buildings shall not be founded on fill material unless the conditions of section 6.4 have been met.

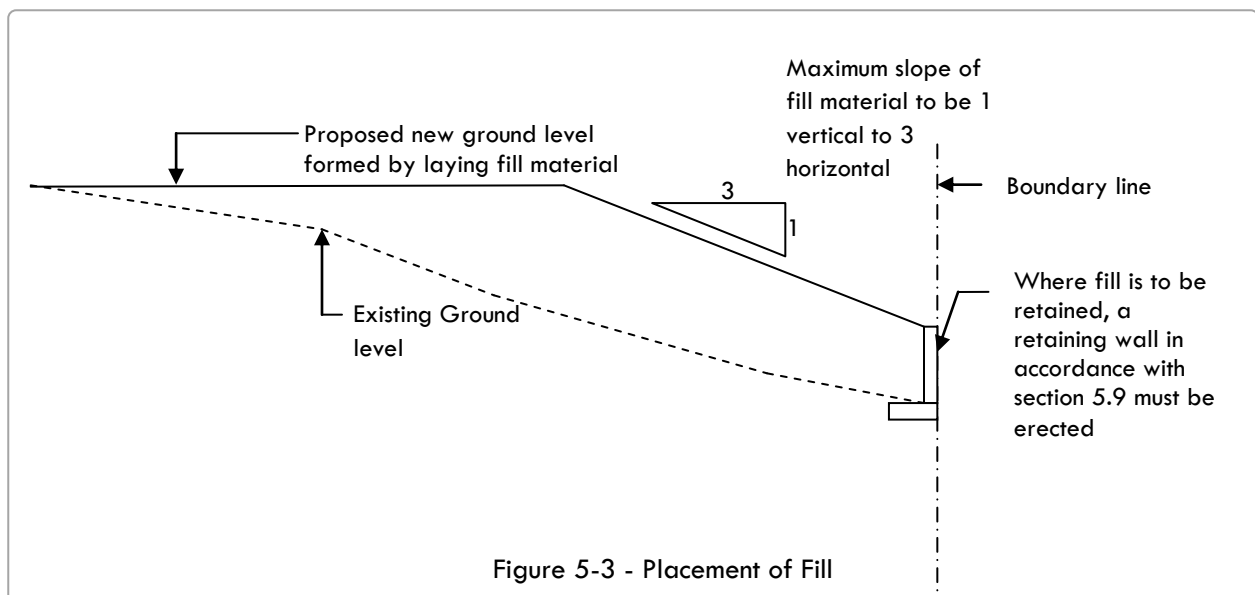

### 5.8 SITE GRADING

The surface immediately adjacent to the building shall be sloped away from the walls.

### 5.9 RETAINING WALLS

#### 5.9.1 GENERAL

Retaining walls complying with Tables 5.1 and 5.2 and Figures 5.4, 5.5 and 5.6 may be used when the soil behind the wall is free draining and all of the conditions listed below are adequately complied with. All retaining walls shall be inspected and approved by a registered engineer prior to inspection by the *Building Official*.

#### 5.9.2 SLOPE BEHIND WALL

The surface of the fill behind the wall is not to exceed a slope of 1 vertical to 3 horizontal.

### **5.9.3 SURCHARGES BEHIND THE WALL**

The walls have been designed so as to accommodate vehicular loads from passenger cars. Where they are subject to higher surcharge loads such as from a public or private road or from a building foundation, these Tables are not applicable. In these cases a registered engineer shall be consulted.

#### **5.9.3.1 RETAINING WALLS ALONG PUBLIC ROADS**

All retaining walls along public roads and highways shall be subject to design criteria defined by the Ministry of Public Works.

### **5.9.4 GROUTING THE WALL**

All cells in the masonry retaining walls shall be concrete filled as per section 14.7.

### **5.9.5 DRAINAGE BEHIND THE WALLS**

#### **5.9.5.1 GRAVEL LAYER**

A layer of free draining gravel a minimum of 6" wide shall be placed behind the wall for its full height.

#### **5.9.5.2 WEEP HOLES**

Weep holes shall be placed at maximum centres of 4' no more than 8" above the base of the wall. The weep holes shall comprise of staggered openings in the masonry, 2" wide x 8" high or of 3" internal diameter PVC pipe. The inside of the weep holes shall be covered with filter cloth or equivalent material to prevent material behind the wall from washing out.

### **5.9.6 REINFORCING**

#### **5.9.6.1 SIZE & SPACING**

The amount of vertical reinforcing in the wall shall be as per Table 5.1 and will vary depending on the height of the wall.

#### **5.9.6.2 PLACEMENT**

The reinforcing is to be placed 3" from the earth retaining face of the wall. Particular care must be exercised to position the reinforcing correctly in the foundations and walls.

#### **5.9.6.3 LAP LENGTH**

The minimum lap length of the reinforcing shall be in accordance with Table 14.3.

### **5.9.7 GUARDS**

Guardrails in accordance with section 4.6 shall be provided to the top of walls where the difference in grade exceeds 4' above soil or sand or 30" above a hard surface.

### **5.9.8 BOUNDARIES**

Where retaining walls are being constructed on or near boundaries, the location of the boundary shall be determined by a registered surveyor. No part of the wall, including the foundation, shall be constructed on the adjacent property unless approval in writing is obtained from the neighbouring property owner.

### **5.9.9 CONCRETE**

All concrete works shall comply with Chapter 13.

**5.9.10 MASONRY**

All masonry works shall comply with Chapter 14.

Required spacing of Vertical Reinforcing for bar size of;				
Maximum Retained Height (H)	Wall Thickness	T12	T16	T20
4'	8"	24"	40"	48"
	10"	40"	48"	48"
	12"	48"	48"	48"
6'	8"	N/A	N/A	N/A
	10"	N/A	24"	32"
	12"	16"	32"	40"
8'	8"	N/A	N/A	N/A
	10"	N/A	N/A	N/A
	12"	8"	N/A	N/A

Notes:

1. Reinforcing is to be placed 3" from the earth retaining face of the wall.
2. All cells of the blockwork retaining walls shall be grouted with concrete fill.
3. N/A means not applicable.
4. Minimum lap length of reinforcing bars shall be in accordance with Table 14.3.
5. Refer to Table 14.4 for equivalent imperial bar sizes to the metric reinforcing designated in the Tables.

Minimum foundation width (W) for various wall types			
Maximum Retained Height	Wall Type 1	Wall Type 2	Wall Type 3
4'	2'- 8"	3'- 6"	2'-8"
6'	4'- 0"	5'-0"	4'-0"
8'	5'- 0"	7'- 0"	5'-0"

**Note:**

1. Foundations are to be a minimum of 12" deep.
2. Foundations are to be reinforced with transverse steel (As) across the foundation using the same size and spacing of reinforcing as the wall. This steel shall be placed in the foundation with 3" cover.
3. Longitudinal reinforcing of T12 bars at 12" c/c shall be placed continuously along the length of the foundation.
4. A T12 longitudinal bar shall be placed on top of the bend of the wall starter bars.
5. The cover to the foundation reinforcing shall be 3".
6. The minimum bend into the foundation of the wall starter bars shall be 16".
7. The wall types shall be as per Figures 5.4, 5.5 and 5.6.

Wall type 2 shall also have foundation keys installed in accordance with Table 5.3

Table 5.1- Concrete Masonry Retaining Walls: Size of Blockwork & Reinforcing

Table 5.2 - Masonry Retaining Walls: Foundation Size & Reinforcing

Type of Foundation Material		
Maximum Retained Height	Rock	Sand
4'	12"	18"
6'	12"	24"
8'	18"	30"

**Note:**

1. The foundation keys described in Table 5.3 are only required for wall type 2.
2. The minimum width of foundation keys shall be 8".
3. Keys shall be continuous along the length of the retaining wall.
4. Keys shall be reinforced with L shaped bars, T12 at 12" centre to centre along the entire length of the foundation.

A continuous longitudinal T12 bar shall be placed in the bottom of the key.

Table 5.3 - Required depth of Keys in Footings for Wall Type 2

**Retaining Wall Type 1**

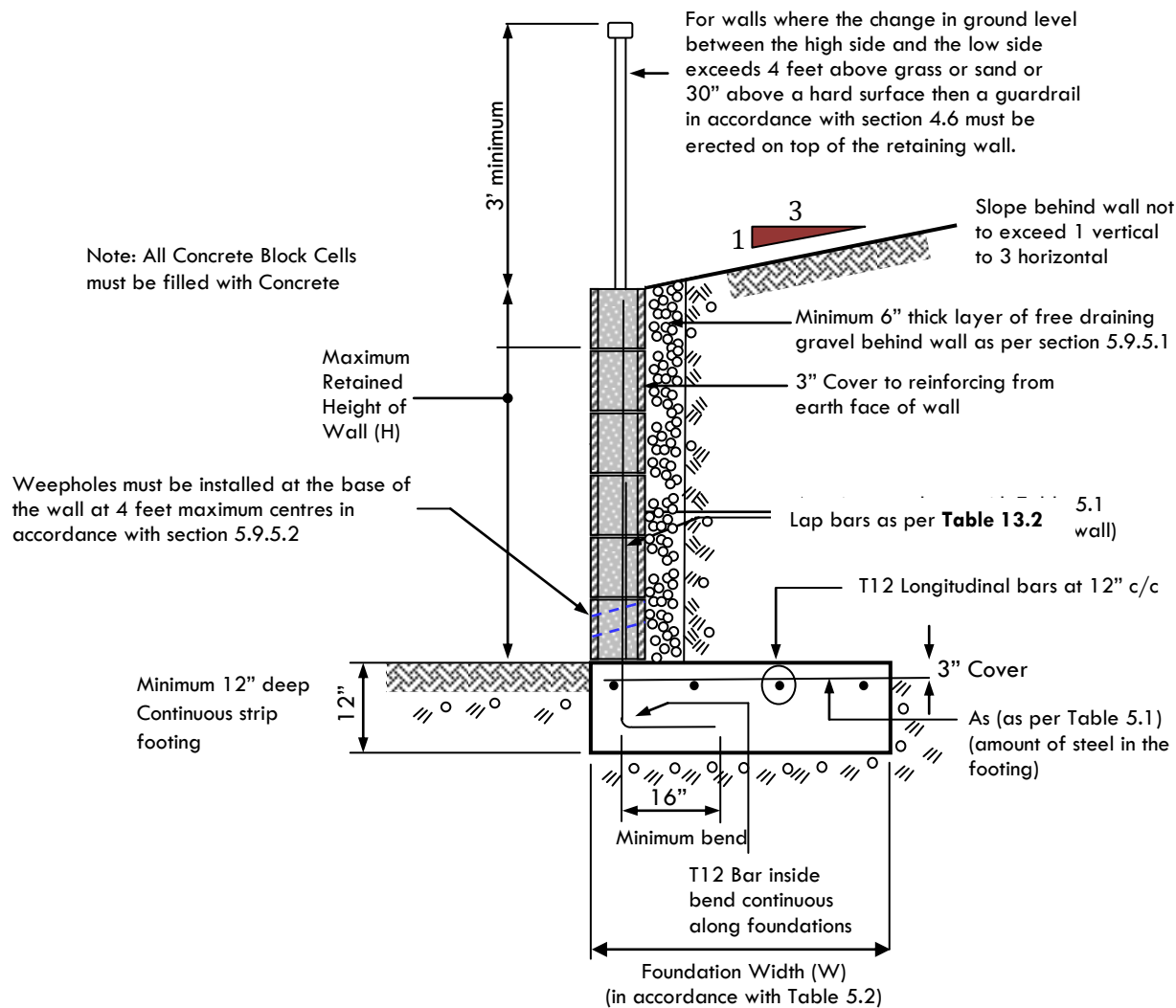

**Figure 5-4 - Retaining Wall Type 1**

**Retaining Wall Type 2**

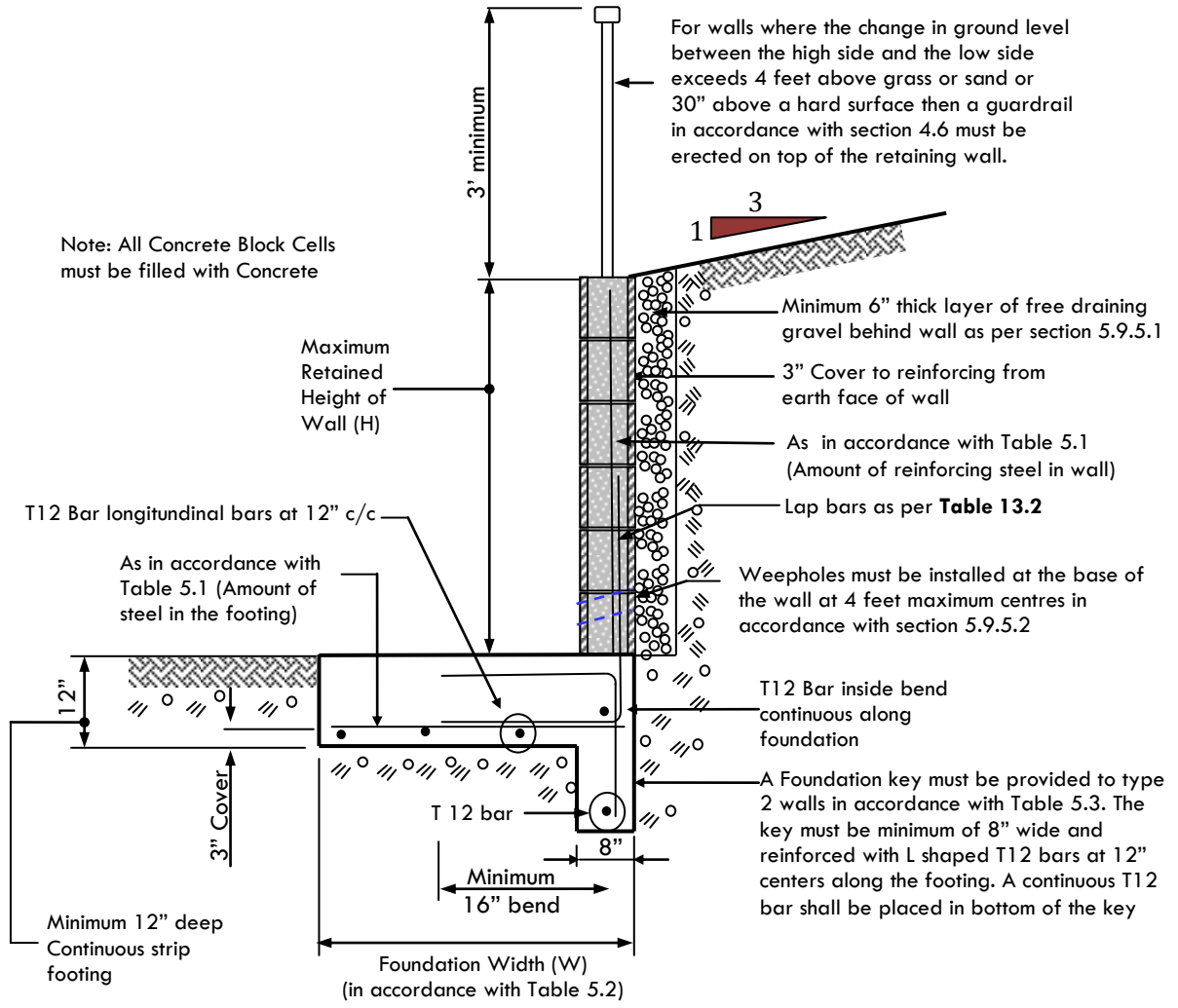

**Figure 5-5 - Retaining Wall Type 2**

**Retaining Wall Type 3**

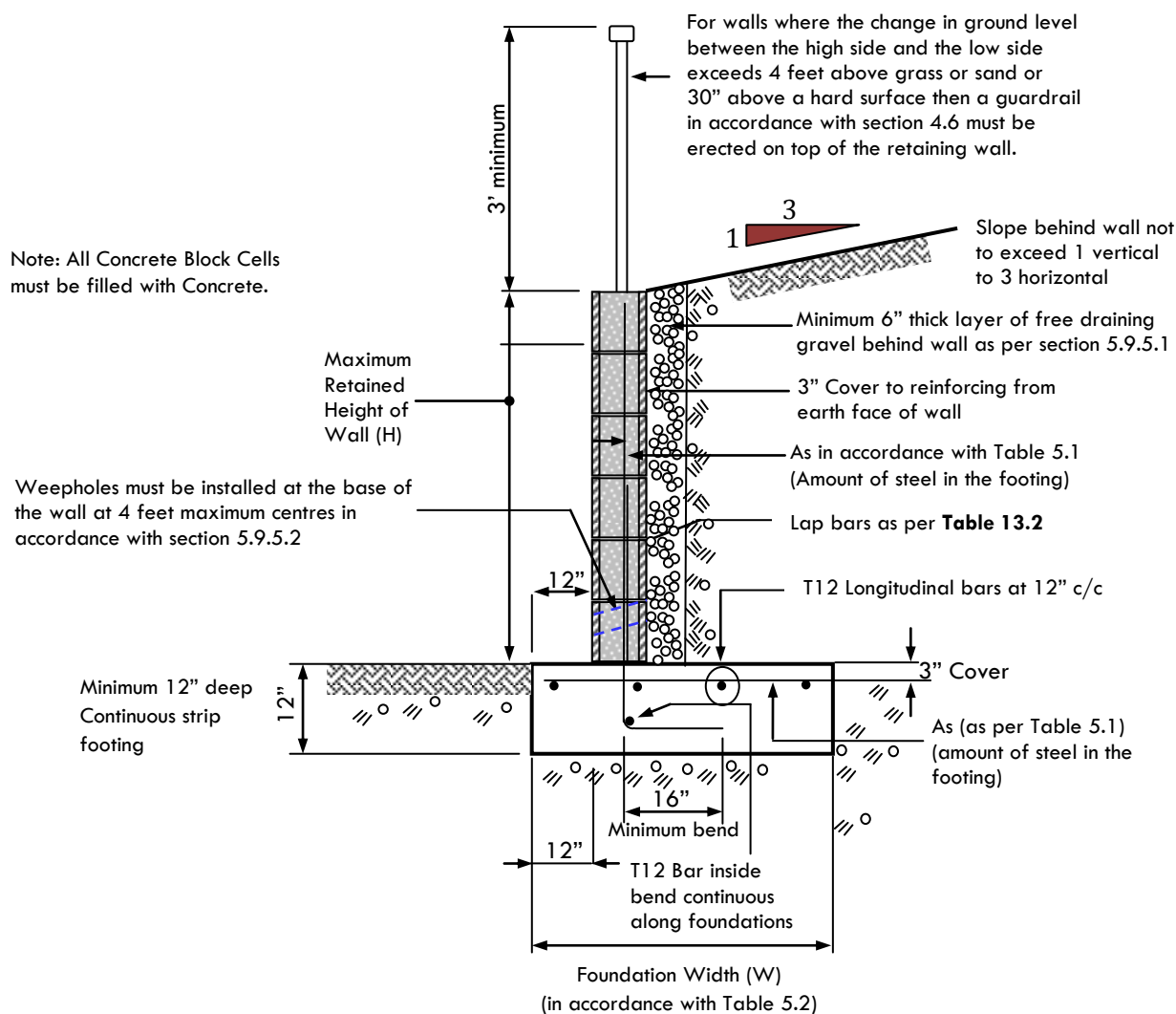

**Figure 5-6 - Retaining Wall Type 3**

**5.10 BIOENGINEERED WALLS AND EMBANKMENTS**

Alternative soil retaining systems in excess of 4' in vertical height shall be inspected and approved by a registered engineer prior to inspection by the *Building Official*.



## 5.11 CERTIFICATE OF INSTALLATION

A certificate of installation in accordance to the manufacturer's specifications must be furnished at the time of completion by a certified installer.

## 5.12 FREE STANDING WALLS

### 5.12.1 GENERAL

Free standing walls that do not retain any material may be constructed to the requirements of table 5.4.

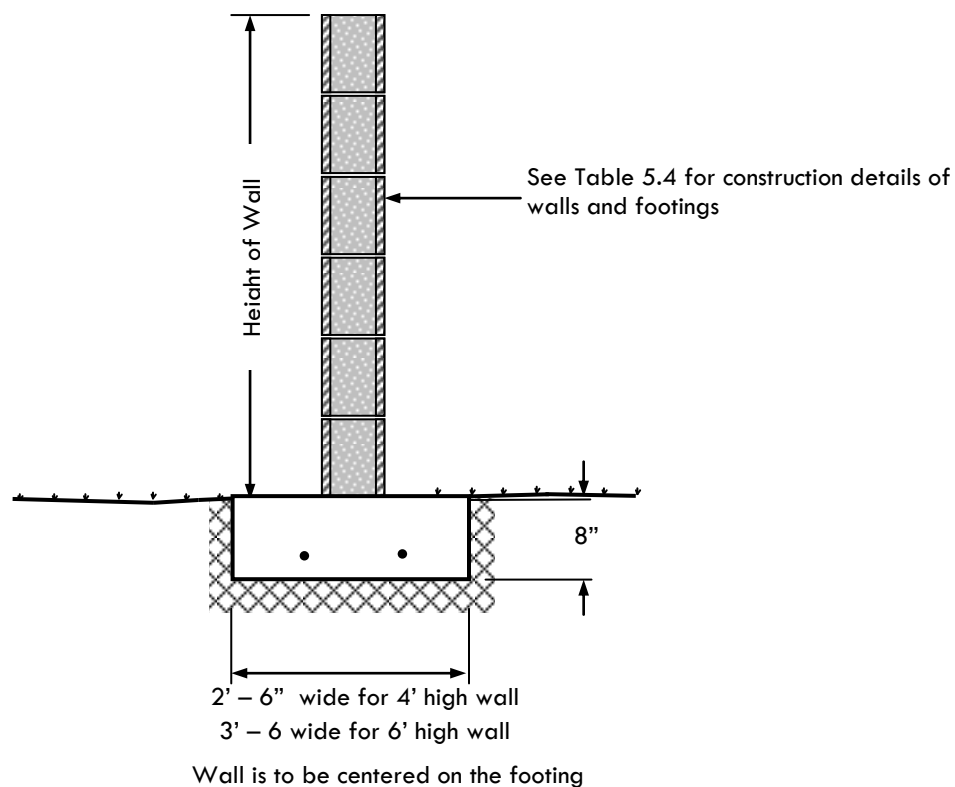

Figure 5-7 - Free Standing Wall Construction

### 5.12.2 BOUNDARIES

Where walls are being constructed on or near boundaries, the location of the boundary shall be determined by a registered surveyor. No part of the wall, including the foundation, shall be constructed on the adjacent property unless approval in writing is obtained from the neighboring property owner. All such walls shall be inspected and approved by a registered engineer prior to inspection by the *Building Official*.

Free Standing Wall Construction							
Height of Wall	Bermuda Stone Wall	Blockwork Ungrouted	Blockwork Fully Grouted	8" Block Reinforced	10" Block Reinforced	Foundation Size	Foundation Reinforcing
4 Feet	8" Bda Stone	8" Block	6" Block	Not required	Not required	2'- 6" wide x 8" deep	2T12
6 Feet	10" Bda Stone	10" Block	8" Block	T16 @ 32" c/c	T12 @ 24" c/c	3' – 6" wide x 8" deep	3T12

**Notes:** With reinforced masonry the bars shall be placed vertically in the centre of the cells and only those cells containing reinforcing need be concrete filled. The reinforcing shall be turned a minimum of 12" into the footing below. The foundations shall be reinforced with the required steel the entire length of the strip footing. The wall shall be placed on the centre of the foundation. Refer to Table 14.4 for equivalent bar sizes to the metric reinforcing designated in the Tables.

Table 5.4 - Free Standing Wall Construction

## 5.13 DEMOLITION

### 5.13.1 **SERVICE CONNECTIONS**

Before any building or structure can be demolished or removed, the owner shall notify all utilities having service connections within a building or structure. These include water, gas, electricity, sewer and other connections. A permit to demolish shall only be granted when a letter is obtained from the relevant utility companies stating that their respective service connections have been disconnected.

### 5.13.2 **NOTICE TO ADJOINING OWNERS**

When the building or structure to be demolished is within 15 feet of an adjoining property, written notice of the intent to demolish shall be given to the owner of the neighbouring property prior to application for a building permit and proof of written notice shall accompany the permit application.

### 5.13.3 **SAFETY OF SITE**

The site on which demolition is taking place shall be maintained in a safe manner at all times. Access to the site by members of the public shall be prevented by the use of temporary fences or barriers in accordance with section 34.1.

### 5.13.4 **ASBESTOS REMOVAL**

Prior to applying for a demolition permit, the owner shall ascertain whether the structure or building to be demolished comprises or contains any asbestos containing materials. Where there is

any doubt, the Department of Health should be contacted for clarification. The removal of such waste shall be strictly in accordance with the Department of Health's Asbestos Removal Policy.

#### **5.13.5 REMOVAL OF OTHER HAZARDOUS MATERIALS**

The removal of other hazardous materials such as but not limited to PCB's, refrigerants, and fluorescent tubes shall be removed strictly in accordance with the requirements of the Departments of Health, Public Works and or Environmental Protection.

#### **5.13.6 DISPOSAL OF MATERIALS**

All materials removed from the site shall be disposed of in accordance with the Ministry of Works & Engineering's Waste Disposal Policy.

### **5.14 SITE DRAINAGE**

#### **5.14.1 GENERAL**

The stormwater runoff shall be maintained entirely on the application site. Drainage soakaway pits shall be required to collect runoff in the following situations:

- a) Driveways, parking areas and other hard paved areas of the property;
- b) Roofs of any buildings that do not discharge into a water storage tank;
- c) Water tank overflows where the size of the storage capacity of the water tank is less than that required in section 29.5 of the code, and
- d) In other situations that the *Building Official* deems have the potential to cause a nuisance to public or private property.

#### **5.14.2**

All pits shall be inspected by the *Building Official* prior to covering over.

#### **5.14.3 SIZE OF SOAKAWAY PITS**

The size of the soakaway pits shall be based on the catchment area of the drainage surfaces in question. The sizes specified in Table 5.5 are based on free draining natural limestone rock or sandy material. . Where organic or clay soils or very tightly cemented rock (e.g. Walsingham Formation) is encountered, the percolation rates will be substantially reduced. In these instances the Building Official shall be consulted.

<b>Catchment area (square feet)</b>	<b>Minimum size of soakaway pit</b>
up to 150 sq ft	12" wide x 18" deep drainage trench x width of driveway or 3ft x 3ft x 2ft deep pit
up to 300 sq ft	3ft x 3ft x 4' deep pit
up to 500 sq ft	4ft x 4ft x 4ft deep pit
greater than 500 sq ft	4ft x 4ft x 4ft deep pit every 500 sq ft of catchment along with a drainage trench as per 5.12.4 for each pit

Table 5.5 - Minimum size of Drainage Soakaway Pits

**5.14.4 DRAINAGE TRENCHES TO DRIVEWAYS**

Drainage trenches shall be installed at the base of driveways and at intervals for driveways exceeding 500 sq ft of catchment area. Their purpose is to direct the flow of stormwater to the soakaway pits. These trenches shall be a minimum of 12" in width by 18" depth. These trenches shall be covered by removable grating suitable to stop the ingress of vegetation and leaves and shall be of sufficient strength to resist the loading of traffic above. These trenches shall be maintained on a regular basis to prevent them from clogging up. Alternative drainage methods to these drainage trenches may be provided at the approval of the Building Official.

**5.14.5 HARD SURFACED AREAS**

All other hardsurfaced areas such as parking areas, walkways and patios shall be sloped so as to retain storm water on the property and suitable subsurface drainage installed to direct runoff to the soakaway pit(s) on the property.

**5.14.6 LOCATION OF SOAKAWAY PITS**

Soakaway pits shall not be located closer than 5 feet to any boundary. The top of the pit of the soakaway must not be below the top of the cesspit.

**5.14.7 CONSTRUCTION OF SOAKAWAY PITS**

The pits shall be of the sizes specified in Table 5.5. Where installed under driveways or parking areas they shall be covered with a reinforced concrete slab as for a cesspit and constructed in accordance with Tables 27.1a and 27.1b. The pit slabs must be provided with a removable access hatch not less than 18" x 18". Where installed elsewhere on the property, the pits shall be covered with suitable removable covers that will resist a minimum 300 lb load from pedestrians.

**5.14.8 MAINTENANCE OF SOAKAWAY PITS**

All soakaway pits, trenches and other drains to the pits shall be adequately maintained by the owner to ensure that they do not become blocked by sediment, sand, leaves and other vegetation. Regular cleaning shall take place to ensure that proper drainage is maintained.

**5.14.9 DRAINAGE BOREHOLES**

Where the owner wishes to use drainage boreholes instead of soakaway pits to dispose of surface water runoff, approval must be obtained from the Environmental Authority.

**5.14.10 SUSTAINABLE DRAINAGE SYSTEMS/PERVIOUS PAVEMENTS****5.14.10.1 BUILDING PERMIT/REGULATIONS**

All applications for permeable pavement will have to be furnished with the specifications and installation requirements from the manufacturer of choice. Such applications can possibly be considered and reviewed as minor development applications, otherwise known as a Permitted Development Permit (PDP) or a full Building Permit application which will be subject to affiliated site factors, such as square footage, location and the type of pavement used, etc (see section E 9.4).

**5.14.10.2 CERTIFICATE OF INSTALLATION**

A certificate of installation in accordance to the manufacturer's specifications must be furnished at the time of completion by a certified installer.

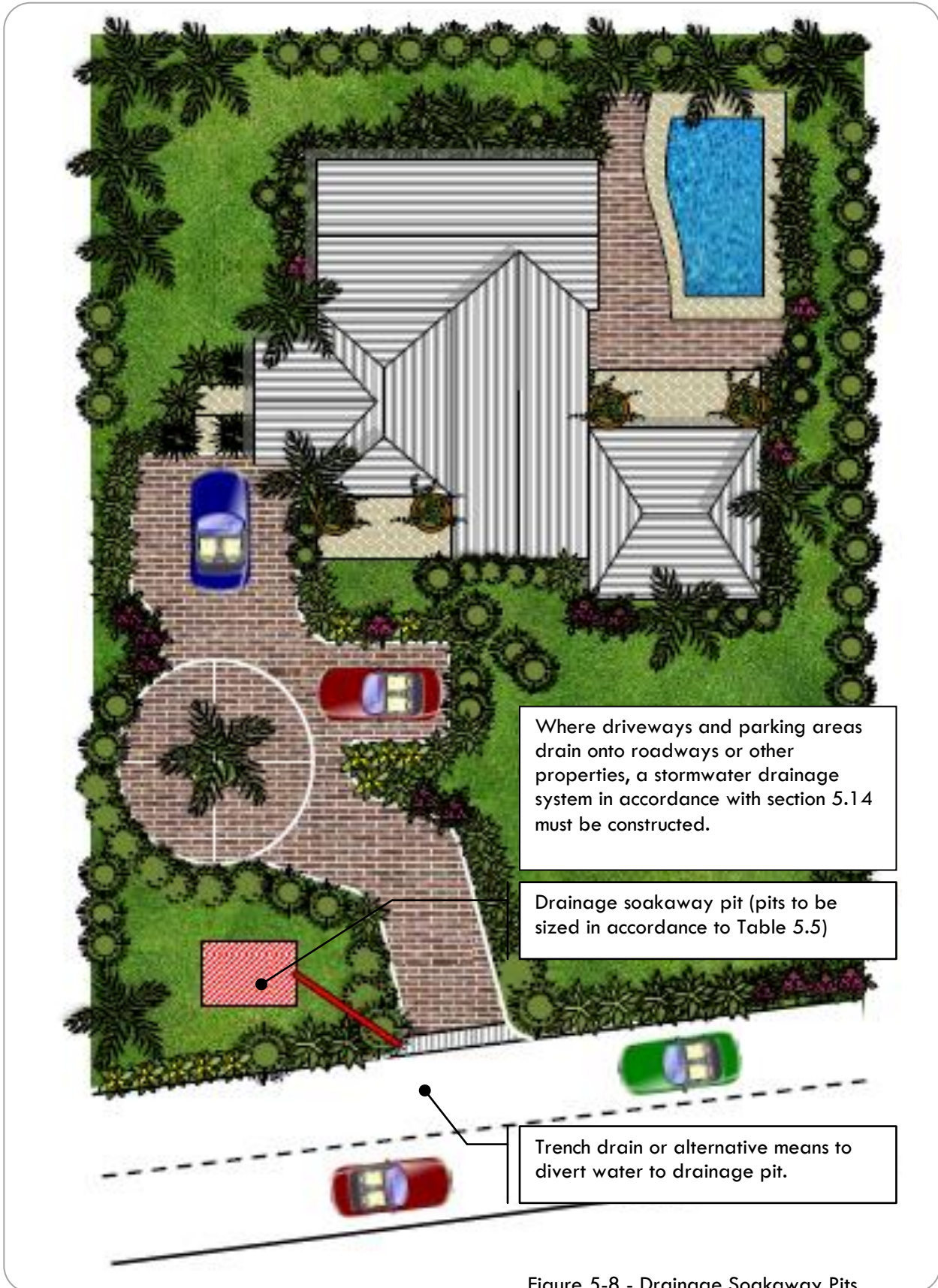

Figure 5-8 - Drainage Soakaway Pits

**5.15**      **CAVES****5.15.1**      ***LOCATION OF BUILDINGS AND OTHER STRUCTURES***

All structures shall be located such as to protect any underlying cave systems. Suitable site investigation works shall be carried out prior to design in an attempt to determine the extent of caves.

**5.15.2**      ***ON SITE DISCOVERY OF CAVE SYSTEMS***

Where a cave is discovered during the progress of construction works, the works on the affected area of the site must cease until an officer from the Departments of Conservation Services and or Environmental Protection has inspected the cave and made a decision on its scientific value.

**5.15.3**      ***STRUCTURAL STABILITY***

Where cave systems are encountered and the applicant is granted permission to construct over or in the location of such caves, a registered engineer shall be consulted in reference to the foundation details of the structure.

---

## **6 FOUNDATIONS**

---

### **6.1 SCOPE**

Foundations in this Chapter have been designed such that they shall be limited to supporting a maximum of 30' of masonry wall, two floors and a heavy roof. Any conditions not specifically covered by this chapter shall be designed, inspected and approved by a registered engineer prior to inspection by the Building Official.

### **6.2 SITE INVESTIGATION**

The applicant shall conduct site investigations to confirm that the site is suitable to carry a structure of the type intended.

### **6.3 SUITABLE FOUNDATION MATERIALS**

Satisfactory bearing materials for spread footing shall include sound rock or compact sand in its natural state. Any organic material, soil or fill shall not be suitable for this code.

### **6.4 UNSUITABLE FOUNDATION MATERIALS**

Where organic material, soil or fill are encountered on site, or where one portion of the building is situated on rock and another portion on sand, the applicant shall engage a registered engineer to design the foundations in accordance with the Bermuda Commercial Building Code.

### **6.5 CONCRETE FOOTINGS**

#### **6.5.1 *GENERAL***

All footings shall be supported on suitable foundation materials in accordance with section 6.3 and they shall be of a minimum size and reinforced as per Table 6.1. Footings shall be constructed of concrete with a minimum 28 day characteristic compressive strength of 2,500 PSI. The cover to the reinforcing shall be a minimum of 3" and a maximum of 4" from the bottom and sides of the concrete footings. Reinforcing shall be lapped in accordance with Table 13.2.

#### **6.5.2 *FORMING OF CONCRETE***

Concrete footings may be cast against the side of excavated natural rock. Where sand is encountered, the sides of the footings shall be formed in accordance with Chapter 13.

#### **6.5.3 *SLOPE***

The top and bottom surface of footings shall be level. Footings shall be stepped where it is necessary to change the elevation of the top surface of the footings. Reinforcing shall be carried through the step in the footings.

Number of Stories	Nature of bearing properties of foundation	
	Rock	Compacted Sand
1-storey	16" wide x 10" deep 2 T12 bars longitudinal	20" wide x 12" deep 2T16 bars longitudinal
2-storey	24" wide x 12" deep 2 T16 bars longitudinal	30" wide x 12" deep 3T16 bars longitudinal
	T10 transverse at 12" c/c	T12 transverse at 12" c/c

**Notes:**

1. Concrete for the foundations shall comply with the requirements of Chapter 13.
2. Where the foundations bear on both rock and sand, see the requirements of section 6.4.
3. The reinforcing designated as longitudinal refers to longitudinal steel that is to be continuous the length of the strip foundation with lap lengths in accordance with Chapter 13.
4. The reinforcing designated as transverse refers to steel across the width of the strip foundation at centre to centre spacing as listed.
5. The cover to the reinforcing shall be 3" from the bottom and sides of the foundation.
6. Refer to Table 13.3 for equivalent imperial bar sizes to the metric reinforcing designated in the Table

Table 6.1 - Minimum Allowable Size and Reinforcing of Concrete Strip Foundations

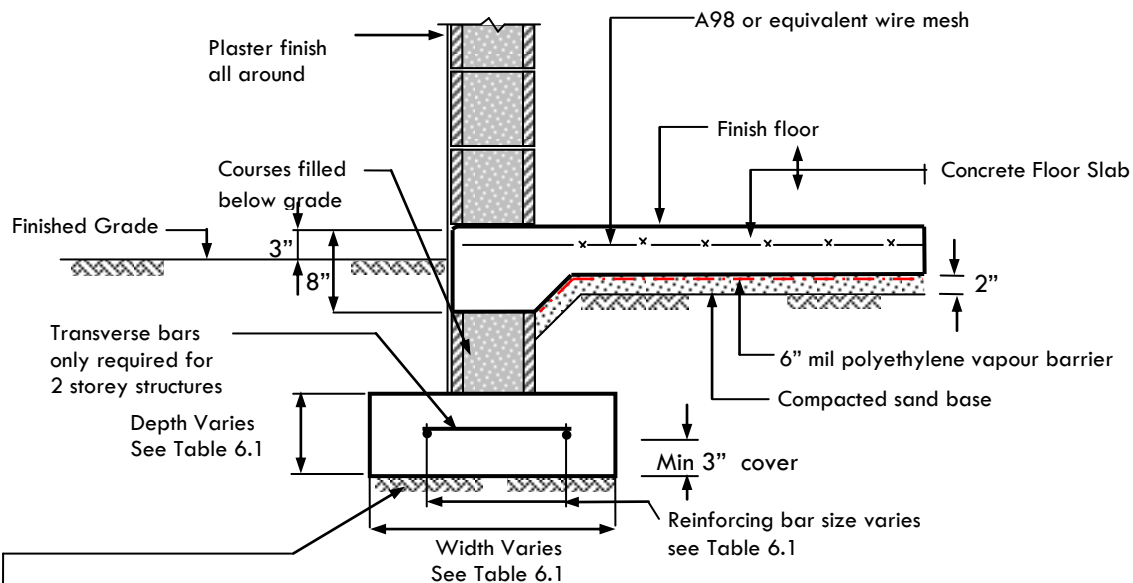

Foundations must be taken down to a sound bearing stratum. Where organic material, soil or fill is encountered, or where part of the foundation is on rock and the other part on sand, then a registered engineer must be consulted

Figure 6-1 – Typical Concrete Foundation



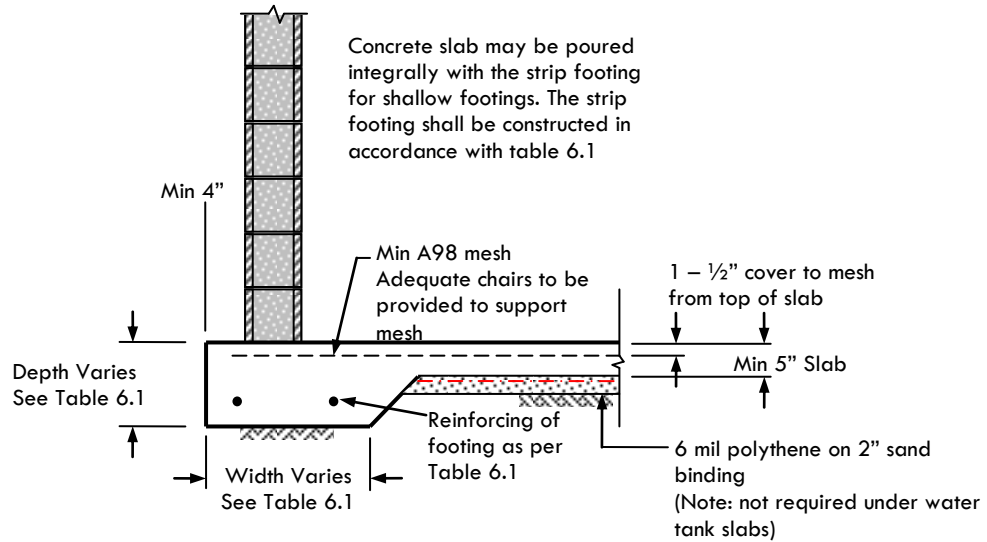

Foundations must be taken down to a sound bearing stratum. Where organic material, soil or fill is encountered, or where part of the foundation is on rock and the other part on sand, then a registered engineer must be consulted

Figure 6-2 – Shallow Footings

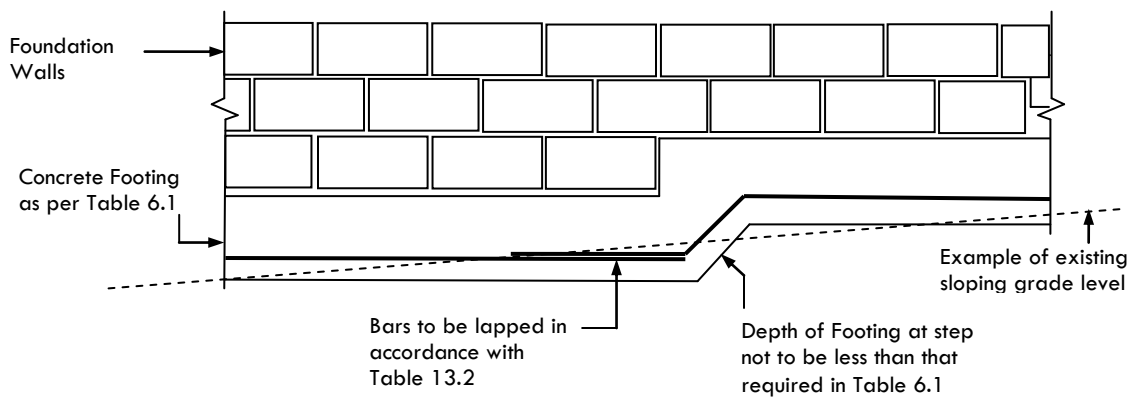

Figure 6.3 – Stepped Footings



---

## **7 FOUNDATION WALLS**

---

### **7.1 GENERAL**

Buildings shall not be founded on fill material unless the conditions of section 6.4 have been met. Any conditions not specifically covered by this chapter shall be designed, inspected and approved by a registered engineer prior to inspection by the Building Official.

### **7.2 UNBALANCED FILL**

Where a foundation wall is placed against anything other than a natural rock cut, the foundation walls shall conform to Table 7.1. Walls supporting more than 9' of fill shall be designed by a registered engineer.

### **7.3 DAMPPROOFING MATERIAL**

Below grade walls for underground rooms shall be adequately damp-proofed. This shall consist of a ½" thick plaster coating on the exterior of the masonry walls. The plaster mix shall be proportioned to 1 part cement: 2 parts sand. Two layers of a bituminous material or other such membrane as approved by the Building Official shall then be applied to the outside face of the wall prior to backfilling.

### **7.4 SUBSOIL DRAINAGE**

Where a site is not graded to drain surface water away from the foundations and/or is of material that is not free draining, a subsoil drainage system shall be installed if deemed necessary by the Building Official. The drain shall be placed around the perimeter of the foundation and consist of a 4" minimum diameter perforated drainage pipe placed on a minimum of 2" of gravel or crushed stone. The perforated pipe shall be covered by an approved filter fabric material then backfilled with gravel or stone extending a minimum of 12" beyond the outside edge of the footing and 6" above the pipe. The underside of the drain pipe shall be not greater than 6" above the top of the footing. The drain shall dispose of the water by gravity to an approved drainage system or soakaway.

### **7.5 BACKFILL**

The foundation walls shall be backfilled with material that is free from organic material construction debris and large rocks. The backfill shall be placed and compacted in a manner that does not damage the dampproofing material.

Height of Unbalanced Soil	Masonry Size	Reinforcing
4'	8" Block	Not Required
5'	8" Block	Not Required
6'	8" Block	Not Required
7'	8" Block	T12 @ 24"c/c
8'	10" Block	T12 @ 24"c/c
9'	12" Block	T12 @ 24"c/c

**Note:**

- a) Unbalanced soil is the difference in height of the exterior and interior finished grade levels. Where an interior slab is provided the height of unbalanced fill shall be measured from the exterior finished grade to the top of the interior slab.
- b) The maximum vertical height between lateral supports shall be 9'.
- c) All cells of the walls shall be concrete filled in accordance with section 14.7.
- d) With reinforced masonry the bars shall be placed vertically in the centre of the cells. The reinforcing shall be turned a minimum of 12" into the footing below and 12" into a concrete slab or concrete bond beam above.
- e) Minimum lap length of reinforcing bars shall be in accordance with Table 14.3.
- f) These foundation walls must be adequately propped at floor level by a concrete slab or timber floor above.
- g) Refer to Table 14.4 for equivalent imperial bar sizes to the metric reinforcing designated in the Table.

Table 7.1 - Foundation Wall Construction

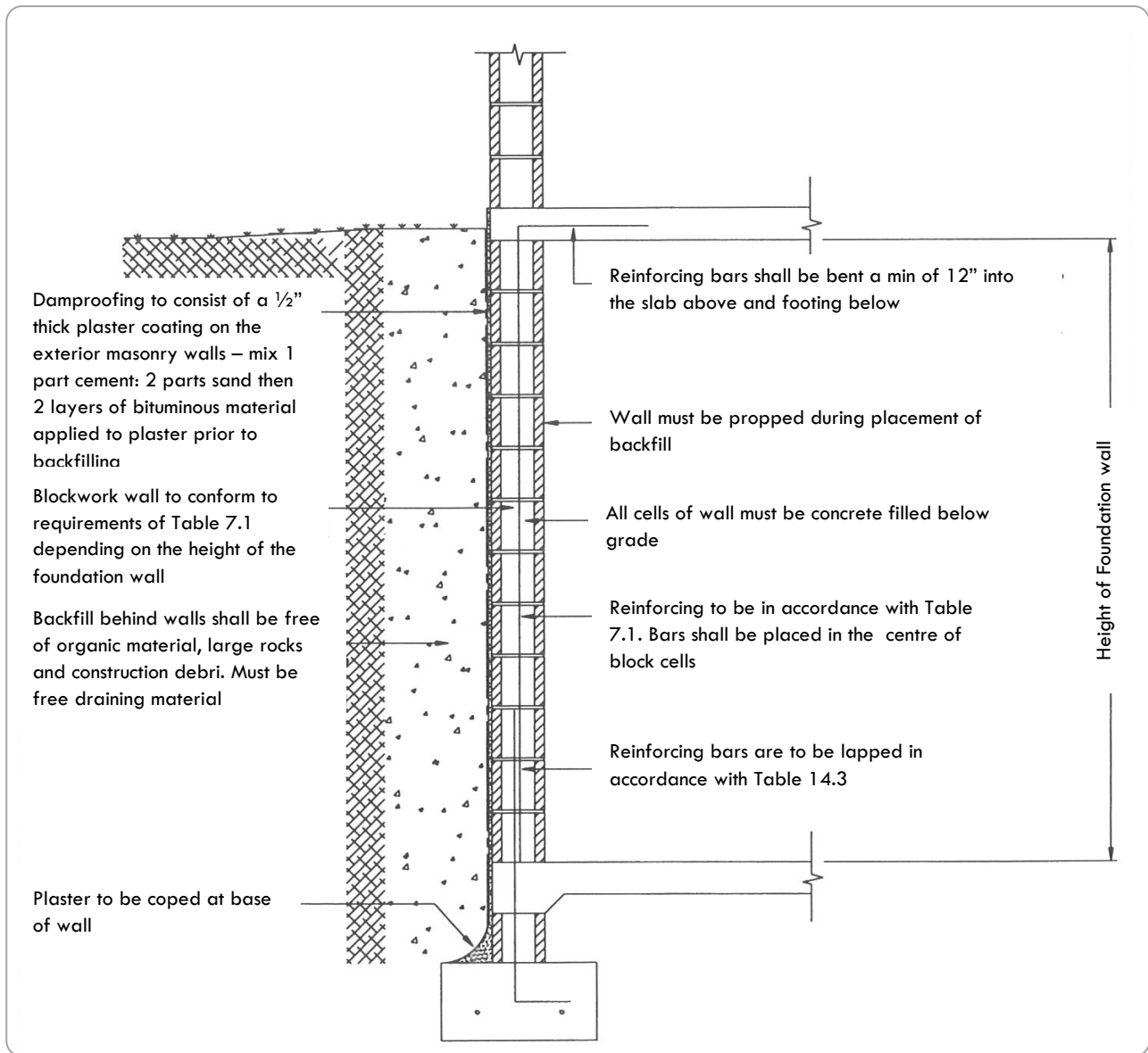

Figure 7-1 – Foundation Wall Construction



## **8 FLOORS**

---

### **8.1 GENERAL**

Any conditions not specifically covered by this chapter shall be designed, inspected and approved by a registered engineer prior to inspection by the Building Official.

### **8.2 CONCRETE GROUND FLOORS ON GRADE**

#### **8.2.1 CONSTRUCTION**

The slabs shall be constructed of concrete in accordance with Chapter 13. The minimum thickness of on-grade concrete slabs shall be 5". They shall be reinforced with a minimum of A98 mesh or 6x6x10 gauge mesh or equivalent. This mesh shall be lapped a minimum of one square at joints. Reinforcement shall extend to within 3" of the outside edge of the slab. The mesh shall be placed 1½" from the top of the slab and be adequately supported to prevent sagging during concrete placement.

#### **8.2.2 BASE**

Slabs may be placed on graded natural rock or sand or on granular fill material but in all cases a level surface shall be provided. Where granular fill is used, it shall be placed and compacted in layers not exceeding 6". The maximum overall thickness of granular fill shall be 12". A 2" thick layer of sand shall be placed over the top of the rock or granular fill material in order to protect the vapour barrier.

#### **8.2.3 VAPOUR BARRIERS**

A vapour barrier shall be placed below all slabs on grade floors. It shall consist of a polyethylene (polythene) sheet of minimum 6 mil (6/1000th of an inch) thickness. The sheets shall be lapped not less than 6" where continuously taped at joints or 18" otherwise. Penetrations through the vapour barrier shall be adequately taped prior to concrete placement. Supports for reinforcing shall be such that they do not damage the vapour barrier.

#### **8.2.4 PERIMETER OF SLAB**

Slabs can either be poured onto the foundation walls below or they can be thickened at their edges. Slab thickening shall receive a footing as per section 6.5 which can be poured integrally with the slab for shallow footings.

#### **8.2.5 SUPPORT TO NON LOADBEARING WALLS**

Slabs beneath non-loadbearing walls constructed of block work larger than 8" in thickness shall be thickened as follows: to a depth of 8" and a width of 12" and reinforced with a minimum of 2 T12 continuous bars. Loadbearing walls shall receive a footing as per section 6.5.

#### **8.2.6 GROUND FLOOR LEVEL**

The finished floor level of the ground floor at points of egress from the building should be a minimum of 4" above the level of the adjoining finished grade level. The grade adjacent to the building shall be sloped away for drainage purposes. If a finished floor is more than 4" above outside grade level, a landing and/or a concrete pad shall be provided and adjusted accordingly. Landings shall be defined as surfaces in concrete, brick or other suitable material.

### **8.3        SUSPENDED CONCRETE FLOORS**

#### **8.3.1        CONSTRUCTION**

All concrete shall be in accordance with Chapter 13.

#### **8.3.2        SUSPENDED GROUND FLOOR SLABS**

The underside of these slabs shall be a minimum of 18" above the grade beneath. To prevent dampness the minimum area of ventilation openings in the foundation walls shall be 1 sq.ft. for every 500 sq.ft. of crawl space. One such ventilation opening shall be within 3' of each corner of the building. Access shall be provided to the sub-floor areas by a crawl hole a minimum of 18"x24" in size. The underside of metal deck slabs shall be coated with an approved bitumen based material. The metal decking itself shall conform to the requirements of section 8.3.4. The underfloor grade shall be cleared of all vegetation and organic material.

#### **8.3.3        CAST IN PLACE SLABS**

Cast in place concrete slabs, formed on the underside shall be in accordance with Tables 8.1 through 8.6, inclusive. Slabs that are outside the scope of these tables shall be designed by a registered engineer.

#### **8.3.4        METAL DECK FLOORS**

Composite steel systems shall not be in damp or wet locations, unenclosed porches, or over a water tank. They may be used elsewhere provided all the following conditions are met:

- a) use must be strictly in accordance with the manufacturers specifications and load tables;
- b) information including specification sheets, loading information, deck profile and metal gauge shall be provided with the permit application;
- c) the steel sheets shall be galvanized to a minimum finish of G60 in accordance with ASTM A525 (0.6 ounces /sq.ft.);
- d) shoring of the slab shall be placed in locations specified by the manufacturer and shall be of sufficient strength to support the loads;
- e) site cutting or welding of the metal decking is to be touched up by use of zinc rich paint;
- f) shrinkage mesh reinforcing shall be provided in accordance with the manufacturers specifications;
- g) where the slab is continuous over an intermediate support, negative moment reinforcing shall be provided in accordance with manufacturers specifications; and
- h) metal decking shall rest upon 50 percent of the thickness of the load bearing wall.

#### **8.3.5        SUPPORT TO WALLS ABOVE**

Where suspended slabs support any of the conditions listed below, additional support of the slabs shall be provided in accordance with section 9.7 or as designed by a registered engineer.

- a) non loadbearing wall of 6" unfilled block greater than 10' in height.
- b) non loadbearing wall of 8" unfilled block greater than 8' in height
- c) any loadbearing walls, column loads or other heavy point loads as the Building Official deems significant.



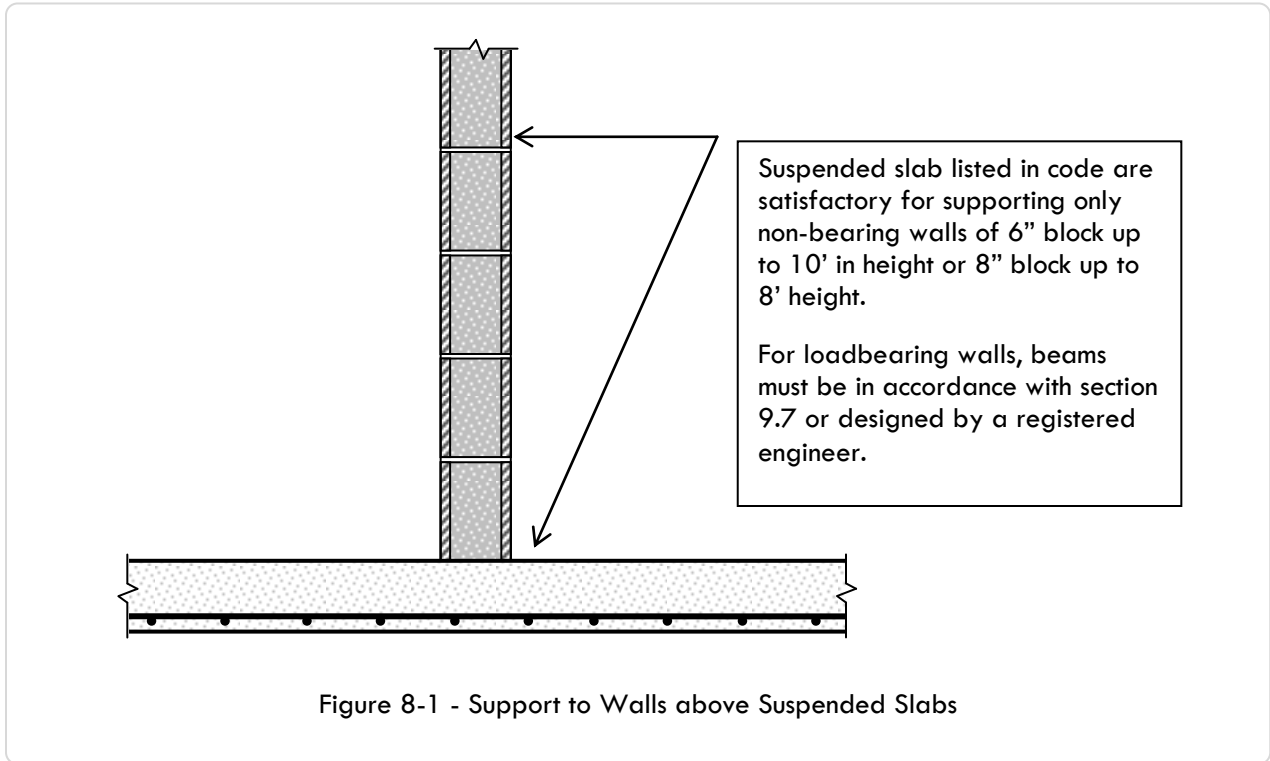

Figure 8-1 - Support to Walls above Suspended Slabs

**8.3.6 BEARING**

The suspended slabs shall bear a minimum of 4" onto masonry or concrete or a minimum of 6" onto sound hard Bermuda stone. Where in renovation works it is not possible to achieve the required bearing, the advice of a registered engineer shall be obtained by the owner and the written recommendation of the engineer shall be submitted to the *Building Official*.

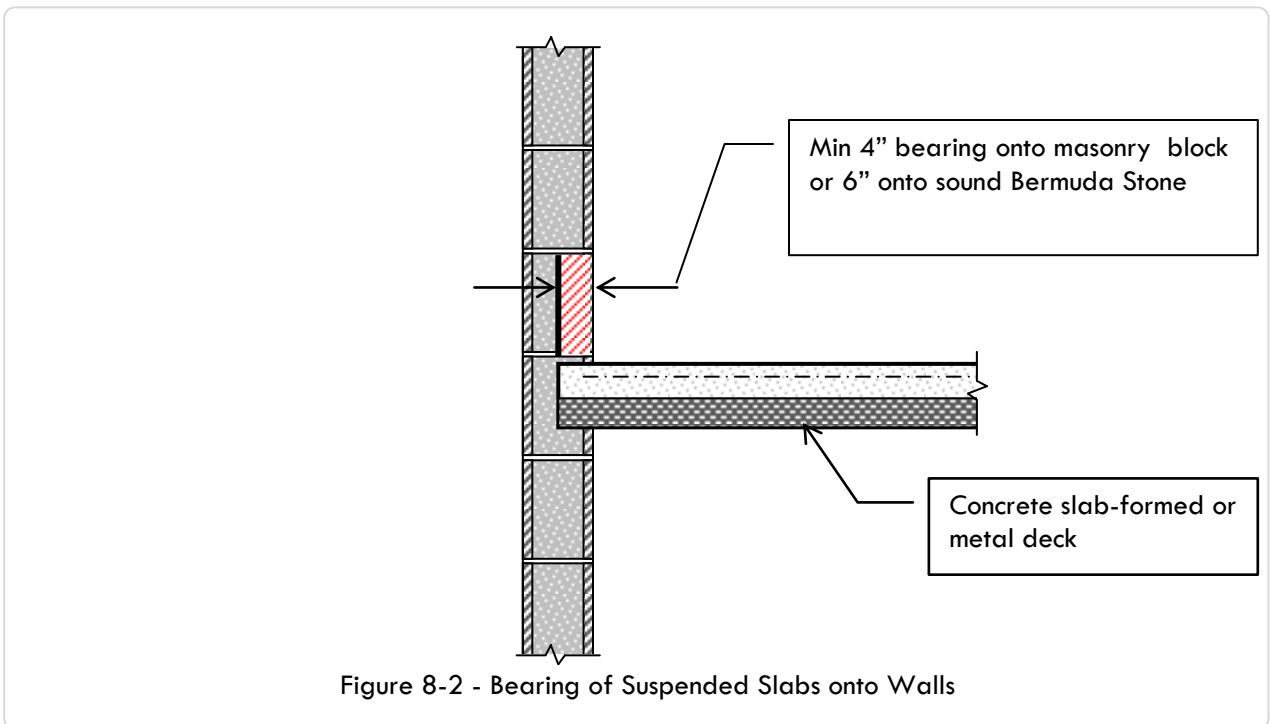
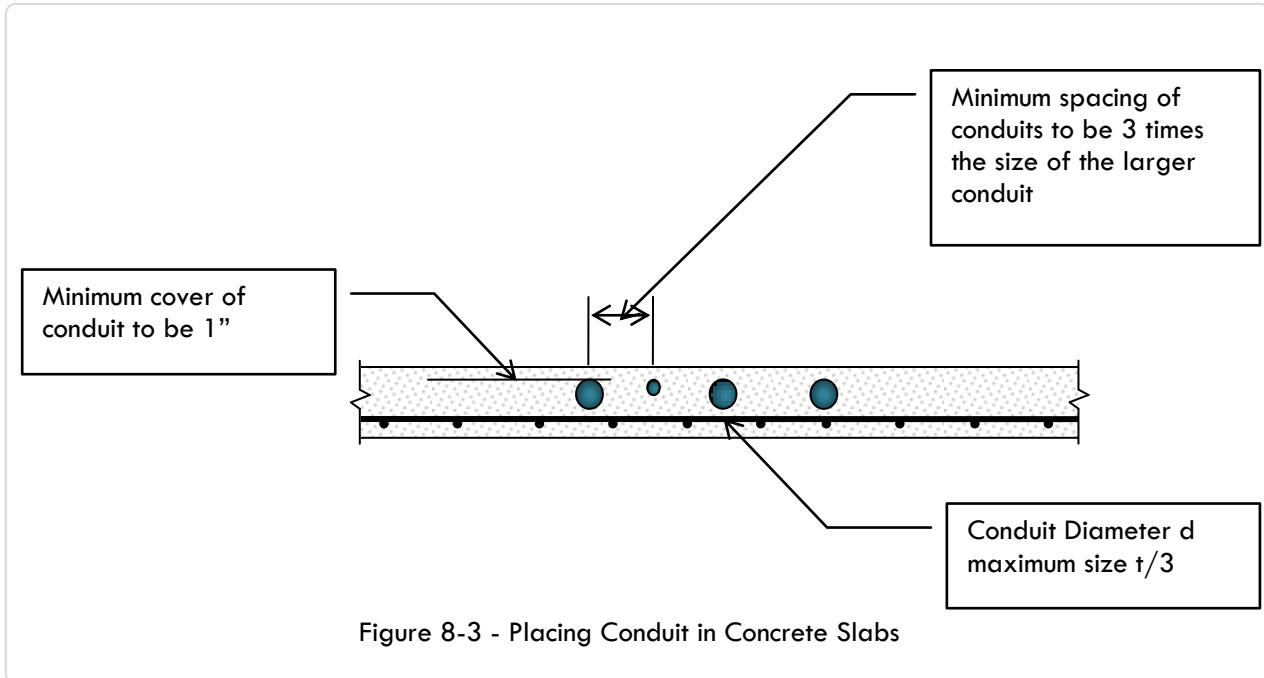

Figure 8-2 - Bearing of Suspended Slabs onto Walls

**8.3.7 CONDUITS**

Conduits shall not be larger in outside dimension than 1/3 of the overall thickness of the slab and they shall be placed not closer than 3 diameters on center. The concrete cover to these conduits shall be not less than 1". Where possible, conduits shall be laid in the center of slabs.



**Suspended Concrete Slabs under Residential Rooms: Maximum Live Load 40psf**

6" thick slabs				
Bar size	Maximum allowable span of slab for bar spacing of;			
	12"	10"	8"	6"
T10	8'	9'	10'	11'
T12	10'	11'	12'	14'
T16	12'	13'	14'	15'

Table 8.1 - 6" thick slabs

8" thick slabs				
Bar size	Maximum allowable span of slab for bar spacing of;			
	12"	10"	8"	6"
T10	9'	10'	11'	13'
T12	12'	14'	15'	16'
T16	15'	16'	17'	18'

Table 8.2 - 8" thick slabs

**Suspended Concrete Slabs under Garages: Maximum Live Load 40psf**

<b>6" thick slabs</b>				
<b>Bar size</b>	<b>Maximum allowable span for bar spacing of;</b>			
	<b>12"</b>	<b>10"</b>	<b>8"</b>	<b>6"</b>
<b>T10</b>	7'	8'	9'	10'
<b>T12</b>	10'	11'	12'	13'
<b>T16</b>	11'	12'	13'	14'

Table 8.3 - 6" thick slabs

<b>8" thick slabs</b>				
<b>Bar size</b>	<b>Maximum allowable span for bar spacing of;</b>			
	<b>12"</b>	<b>10"</b>	<b>8"</b>	<b>6"</b>
<b>T10</b>	8'	9'	10'	11'
<b>T12</b>	11'	13'	14'	15'
<b>T16</b>	13'	14'	15'	16'

Table 8.4 - 8" thick slabs

**Notes for Tables 8.1, 8.2 and 8.3, 8.4**

- 1) The reinforcing specified in Tables 8.1, 8.2 and 8.3, 8.4 is the main span steel (short span) and shall be placed 1½" from the bottom of the slab.
- 2) A minimum transverse distribution of steel comprising of T10 bars at 10" c/c for 6" slabs and T12 bars at 12" c/c for 8" slabs shall be placed in the long span direction. This steel shall be placed on top of the main steel.
- 3) Negative tension reinforcing steel comprising A142 mesh or W 6 X 6 X 6 gauge mesh shall be placed in the top of the slab with 1½" top cover for one third the span either side of all interior supports on walls or beams.
- 4) Refer to Table 13.3 for equivalent imperial bar sizes to the metric reinforcing designated in the Table.

**Cantilevered Concrete Slabs under Garages: Maximum Live Load 60 psf**

Cantilevered Concrete Slabs: Maximum Live Load 60 psf				
Bar size	5" thick slabs			
	Maximum allowable span for bar spacing of;			
	12"	10"	8"	6"
T10	2'-0"	2'-6"	3'-0"	3'-6"
T12	3'-0"	3'-6"	4'-0"	4'-6"
T16	3'-6"	4'-0"	N/A	N/A

Table 8.5- 5" thick slabs

Bar size	6" thick slabs			
	Maximum allowable span for bar spacing of;			
	12"	10"	8"	6"
T10	2'-6"	3'-0"	3'-6"	4'-0"
T12	3'-6"	4'-0"	4'-6"	5'-0"
T16	4'-0"	4'-6"	5'-0"	N/A

Table 8.6 - 6" thick slabs

**Notes for Table 8.5 and 8.6**

- 1) The reinforcing specified Tables 8.5 and 8.6, is the main cantilever steel and shall be placed 1½" from the top of the slab.
- 2) A minimum transverse distribution steel comprising of T10 bars at 12" c/c for 5" slabs and T10 at 10" c/c for 6" slabs shall be placed in the long span direction. This steel shall be placed under the main steel.
- 3) The cantilever slabs have been designed to support their own weight, the uniform live load listed and a masonry 36" high guard wall. Where column loads or line loads from walls are applied, the use of Tables 8.5 and 8.6 is not applicable and the slabs will have to be designed by a registered engineer.
- 4) The cantilever steel shall be carried back a minimum of 1.5 times the cantilever span back into the interior slab, beyond the support wall.
- 5) Refer to Table 13.3 for equivalent imperial bar sizes to the metric reinforcing designated in the Tables.
- 6) A minimum 6" deep drop beam shall be poured at the throat of the cantilever slab on top of the support wall. This shall be reinforced with 2T12 re bars continuous along the length of the cantilever. Where the cantilever is located over an opening, the beams shall be sized and reinforced in accordance with section 9.7.
- 7) Cantilever slabs and drop beams shall be poured integrally (at the same time) with the main slab.
- 8) Reinforcements should be installed at locations of support. Seek engineer for advice.

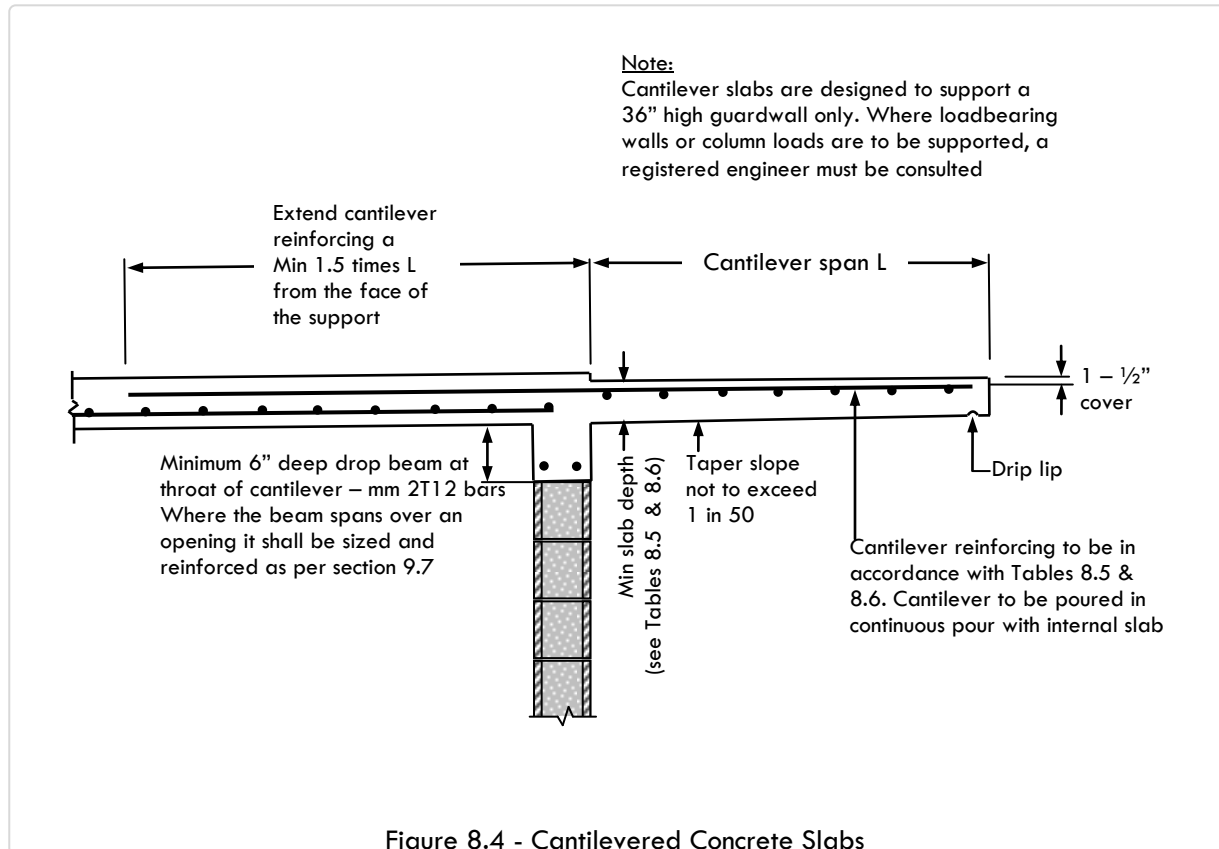

## 8.4 **TIMBER FLOORS**

### 8.4.1 **CRAWL SPACE/VENTILATION**

The underside of the floor joists shall be a minimum of 18" above the grade beneath. To prevent dampness, the minimum area of ventilation openings in the support walls shall be 1 sq.ft. for every 150 sq.ft. of floor area. One such ventilation shall be provided within 3' of each corner of the building. Access shall be provided to the sub ground floor areas by a crawl hole a minimum of 18" x 24" in size. The timbers should be treated with preservative to the minimum standard of 0.25 lb/ft<sup>3</sup> CCA. The underfloor shall be cleared of all vegetation and organic material.

### 8.4.2 **FLOOR FRAMING**

The timber joists shall comply with the requirements of Chapter 15. The allowable spans shall be in accordance with Tables 8.7 and 8.8.

### 8.4.3 **BEAMS UNDER LOADBEARING WALLS AND COLUMNS**

These shall be designed by a registered engineer to support the applied loads.

### 8.4.4 **JOISTS UNDER BLOCKWORK WALLS**

Timber floor joists supporting blockwalls shall not be allowed. Beams designed by a registered engineer are required.

**Simply Supported Floor Joists under Residential Rooms: Max Allowable Live Load 40 psf**

Floor Joist Size	Maximum span for spacing of:		
	12"	16"	24"
(normal inches)	(ft-inch)	(ft-inch)	(ft-inch)
2x6	11'	10'	9'
2x8	14'	13'	11'
2x10	18'	16'	14'
2x12	22'	20'	17'

Table 8.7- Simply Supported Floor Joists under Residential Rooms: Max Allowable Live Load 40 psf

**Simply Supported Floor Joists under Exterior Balconies: Max Allowable Live Load 60 psf**

Floor Joist Size	Maximum span of joists for spacing of:		
	12"	16"	24"
(normal inches)	(ft-inch)	(ft-inch)	(ft-inch)
2x6	9'	8'	7'
2x8	12'	11'	10'
2x10	16'	14'	13'
2x12	19'	17'	15'

Table 8.8 - Simply Supported Floor Joists under Exterior Balconies: Max Allowable Live Load 60 psf

**8.4.5 JOISTS UNDER NON-LOADBEARING PARTITIONS****8.4.5.1 WALLS PARALLEL TO JOISTS**

Joists under parallel non loadbearing partitions shall be doubled. Where the wall falls between two joists solid timber blocking of not less than 2"x4", and on not more than 24" centres is required.

**8.4.5.2 WALLS PERPENDICULAR TO JOISTS**

Non loadbearing walls may run perpendicular to floor joists as long as the base plate of the wall is a minimum of 2"x4" in size.

**8.4.6 LATERAL SUPPORT OF FLOOR JOISTS**

All floor joists shall receive solid blocking at each support except where the joist is continuous over the support. The solid blocking shall be as per section 8.4.6(a). In addition all joists spanning greater than 10' shall receive a row of lateral support at mid span which shall consist of either:

- a) Solid blocking 2" in thickness and the same depth as the joists (blocking can be offset 2" from each other for ease of nailing); or
- b) Herringbone strutting (cross-bridging) consisting of 2"x2" timber set diagonally in opposite directions between the top and bottom edges of every joist. Alternatively an *approved* galvanized strutting may be used.

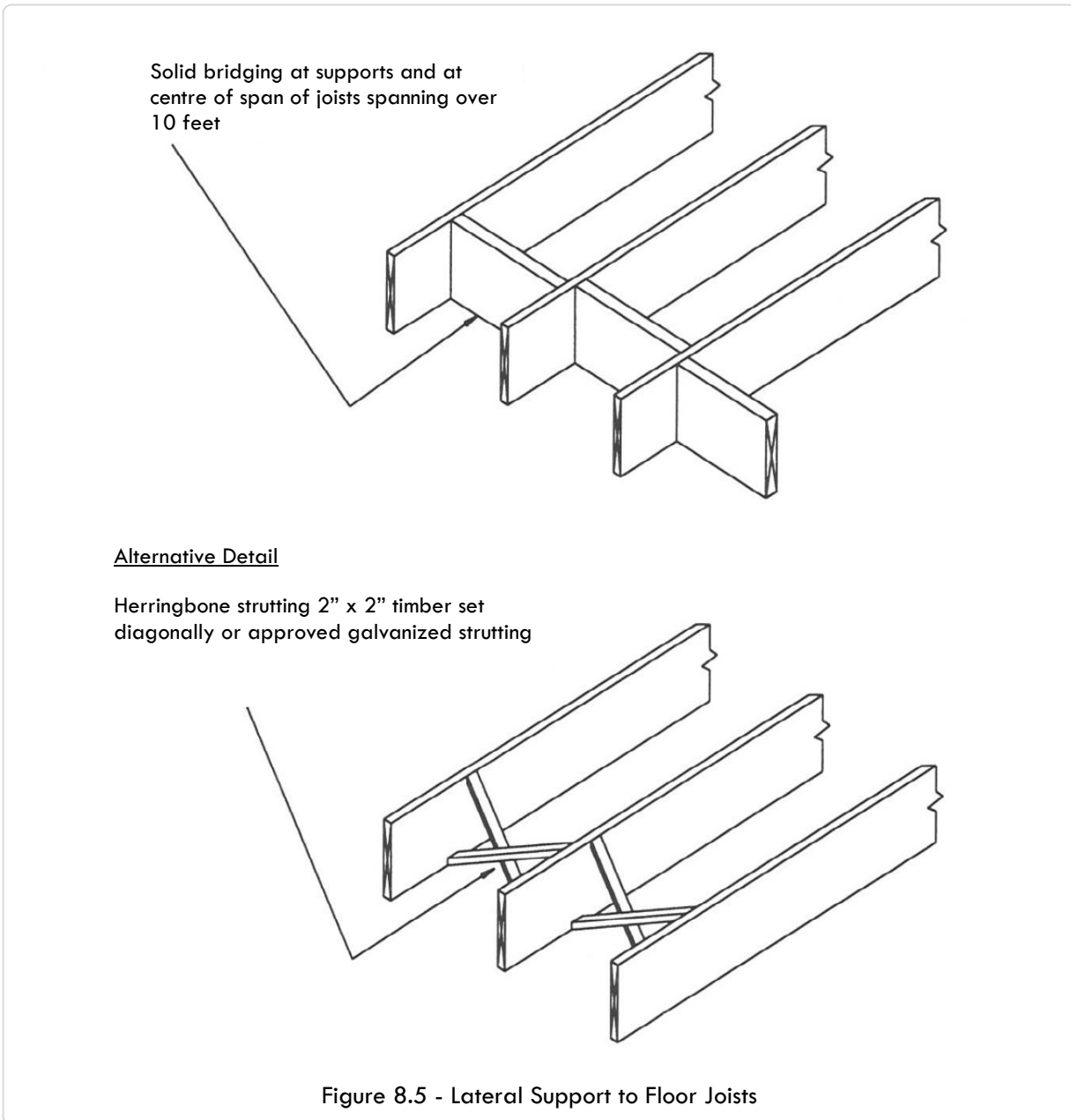

## 8.4.7 SUPPORTS

### 8.4.7.1 BEARING ONTO TIMBER OR STEEL MEMBERS

Floor joists shall have minimum bearing on timber or steel supports of 1 ½".

### 8.4.7.2 BEARING ONTO MASONRY OR BERMUDA STONE WALLS

Floor joists shall not rest directly onto masonry or Bermuda stone. A bond timber of minimum size 1" deep x 2" wide shall be set onto the masonry or sound Bermuda stone. The bond timber (except for Bermuda cedar) shall be preservative treated to a minimum of 0.25 lb/ft<sup>3</sup> CCA. The masonry or stone wall below shall be 2" wider than the wall above in order to provide a support ledge for the joists. An air gap of at least ½" shall be used between the ends and sides of the timber and the

masonry or stone. In addition, a moisture barrier (wood sealer) shall be applied to the ends of the timber joists to prevent dampness entering the timber.

#### 8.4.7.3 SUPPORT BY TIMBER STRINGERS

Alternatively, timber members may be connected to timber stringers (in accordance with section 8.4.8) by the use of approved joist hangers of the minimum allowable capacity specified in Table 8.9. Specification sheets must be supplied of the intended joist hanger.

Minimum Allowable Load of Joist Hanger Connections	
Size of Joist (depth in inches)	Minimum allowable load of connections to header joist
(normal inches)	(ft-inch)
6"	600 lbs
8"	750 lbs
10"	900 lbs
12"	1 100 lbs

Table 8.9 - Minimum Allowable Load of Joist Hanger Connections

#### 8.4.8 TIMBER STRINGERS

Where used, the timber stringers shall be a minimum of 3"x6" in size and shall be connected to the walls in accordance with Table 8.10. The bolts shall be set in the centre of the timber stringers, at the spacing described and at 4" from each end of every section of timber. The bolts shall be cast a minimum of 4" into the opening of the block cell which shall be grouted with concrete. Timber ledgers shall be preservative treated to a minimum of 0.25 lb/ft<sup>3</sup> CCA.

Connection details for Timber Stringers to Masonry Walls	
Span of Floor Joists onto Ledgers	Minimum allowable bolt size and spacing
8'	1/2" bolts at 3' c/c
12'	5/8" bolts at 3' c/c
16'	5/8" bolts at 2' c/c
20'	3/4" bolts at 2' c/c

Table 8.10 - Connection details for Timber Stringers to Masonry Walls



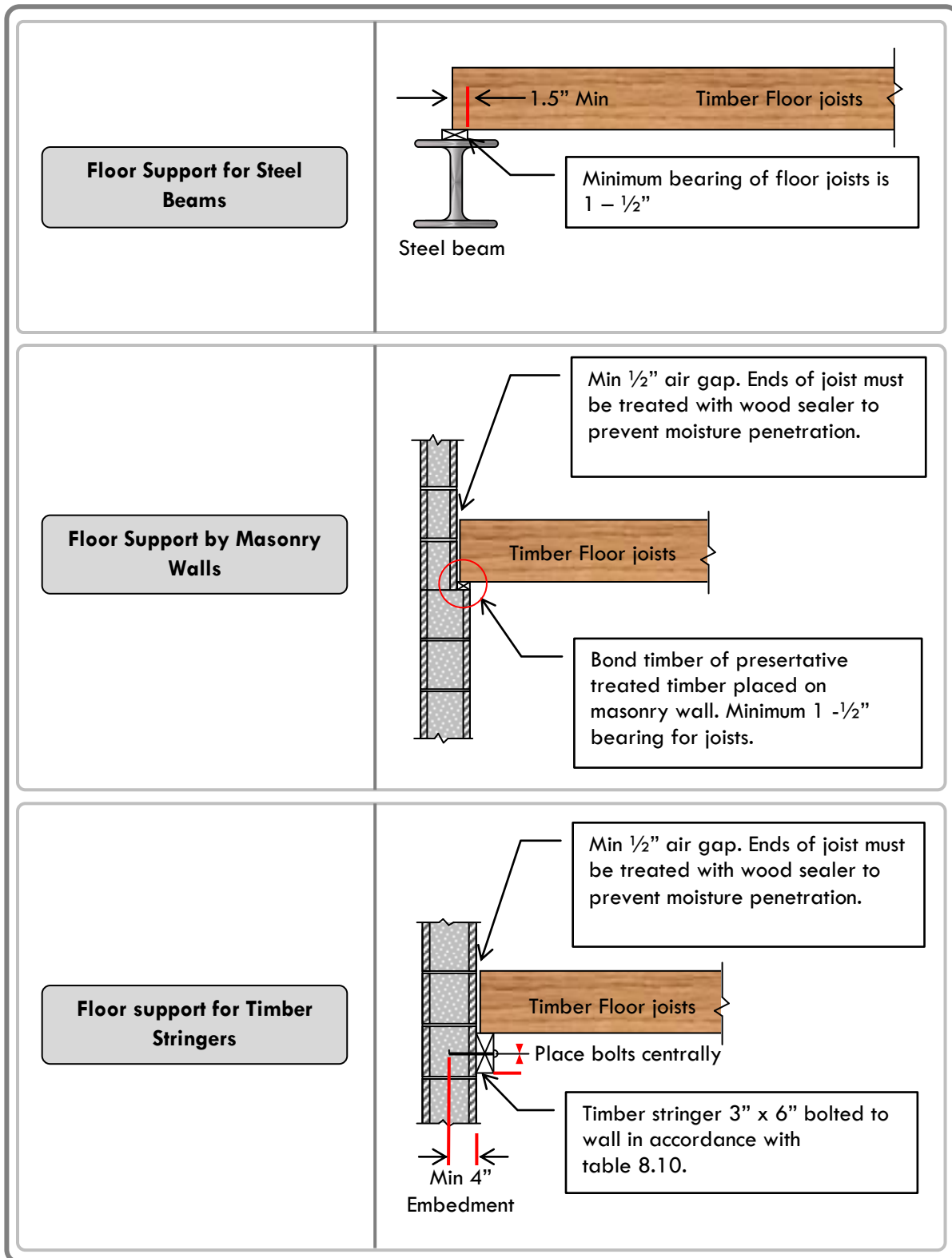

Figure 8.6 - Supports to Timber Floor Joists

### 8.4.9 CANTILEVERED FLOOR JOIST

Floor joists may project as cantilevers beyond the face of the support in accordance with Table 8.11. They shall support only timber handrails or metal handrails. The floor joists shall extend back from the face of the support a minimum of 1.25 times the span of the cantilever, and be connected to the adjacent joists at their end with two ½" diameter bolts. Where the main floor joist runs perpendicular to the span of the cantilever, a double trimming joist shall support the cantilever ends for cantilever spans of up to 5' and triple trimming joists for cantilever spans up to 8'. These trimming joists shall be adequately fastened together. The connection of the cantilever joist to these double trimming joists shall be approved joist hangers that have an allowable working load not less than 600 lbs. Specification sheets shall be provided for these joist hangers.

#### Cantilevered Floor Joists under Exterior Balconies: Maximum Allowable Live Load 60 lbs/ sq.ft.

Cantilever span of Joist (feet)	Required joist size for spacing of:		
	12" (normal inches)	16" (normal inches)	24" (normal inches)
3'	2x6	2x6	2x6
4'	2x6	2x6	2x8
5'	2x8	2x8	2x10
6'	2x10	2x10	2x10
7'	2x10	2x10	2x12
8'	2x12	2x12	N/A

Table 8.11 Cantilevered Floor Joists under Exterior Balconies: Maximum Allowable Live Load 60 lbs/ sq.ft.

**Note:** Cantilever floor joists are sized to support live load and a lightweight guardrail only. Where point loads from columns or line loads from walls are applied, the use of Table 8.11 is not applicable and the joists will have to be designed by a registered engineer.

### 8.4.10 JOINTS IN FLOOR JOISTS

Joints shall only be made over supports except where cantilever joists are used, in which case the requirements of section 8.4.9 shall be followed. Floor joists shall overlap a distance equal to at least the depth of the joist and be nailed with two 16d nails either side.

### 8.4.11 OPENINGS IN FLOORS

Openings shall be framed with header and trimming joists. The trimming joists shall consist of regular floor joists doubled up. Where the header span does not exceed 4' the header joist may consist of a single member the same size as the floor joists. Where the span is between 4' and 8' the header joist shall consist of doubled up joists. For openings greater than 8' the support shall be designed by a registered engineer. Curtailed joists shall be connected to headers with joist hangers in accordance with Table 8.9. Headers shall be connected to trimming joists with connectors having an allowable working load not less than that in Table 8.12.

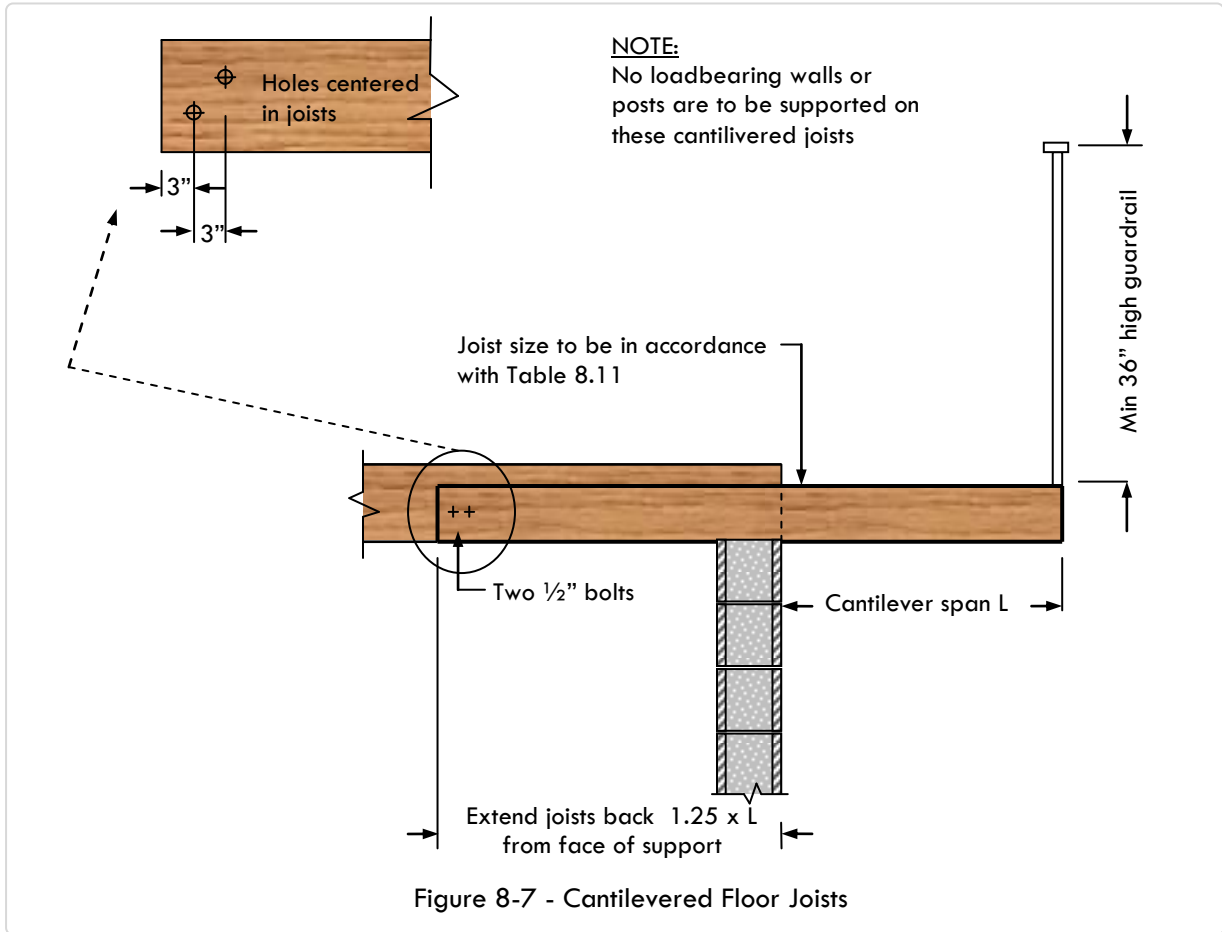

**Minimum Allowable load of connector from Header joist to Trimming joist**

Size of floor joists		
Span of header joist	6" and 8" deep joists	10" and 12" deep joists
4'	500 lbs	900 lbs
6'	750 lbs	1350 lbs
8'	1000 lbs	1800 lbs

**Table 8.12 - Minimum Allowable load of connector from Header joist to Trimming joist**

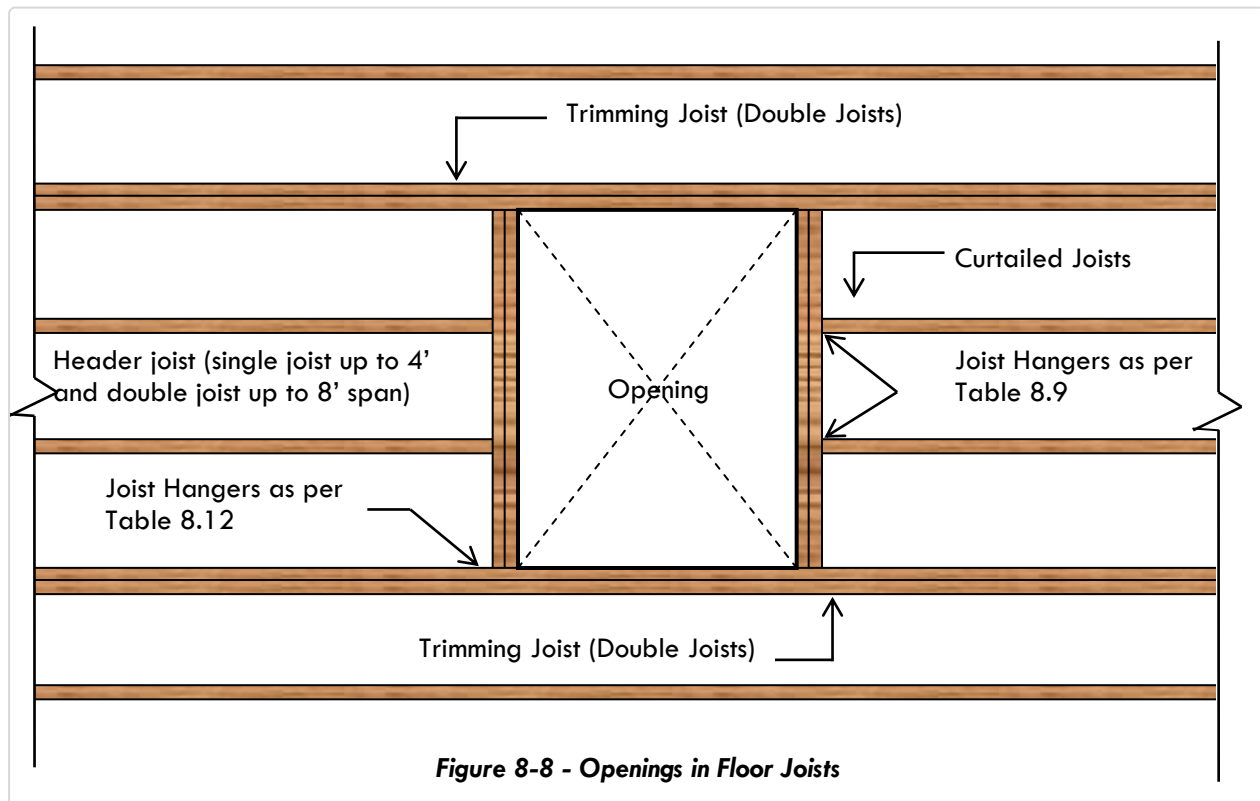

## 8.4.12 HOLES & NOTCHES IN FLOOR JOISTS

### 8.4.12.1 NOTCHES

Notches in timber members shall not exceed  $1/5^{\text{th}}$  of the depth of the member, or be greater in length than  $1/3$  of the depth of the member, and shall not be located in the middle third of the span. The minimum spacing between notches shall be not less than the depth of the member. Notches should not be permitted in cantilever joists over the support.

### 8.4.12.2 HOLES

Holes drilled in timber members shall be within the middle third of the depth of the member and shall be located no closer than 2" from an edge. Holes shall be not more than  $1/5^{\text{th}}$  of the depth or 2" in diameter, whichever is smaller, and the minimum spacing between the edges of the holes shall be not less than the depth of the member.

### 8.4.12.3 HOLES AND NOTCHES IN CANTILEVER JOISTS

Cantilever joists shall not be notched or drilled unless the depth of the joist is increased by the size of the notch. Please refer to the IBC 2012, Section 2308.10.4.2.

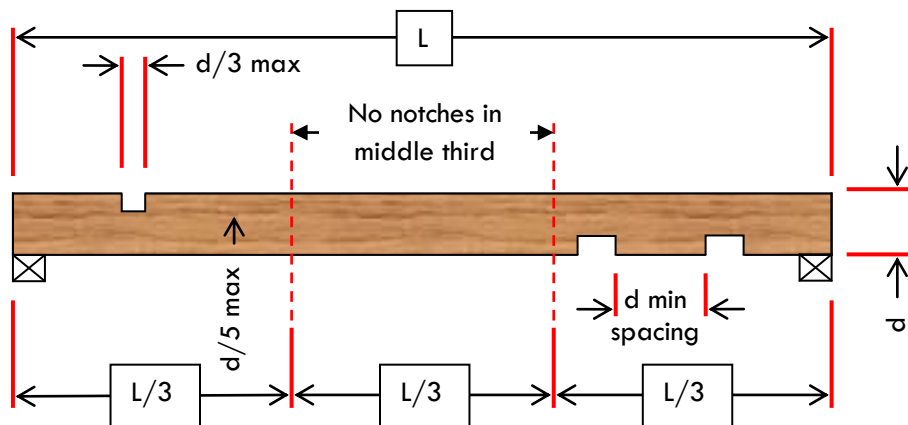

Figure 8-9 - Notches in Floor Joists

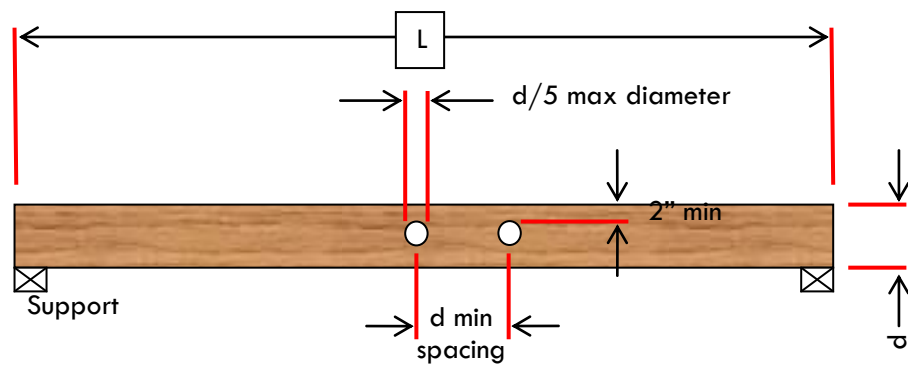
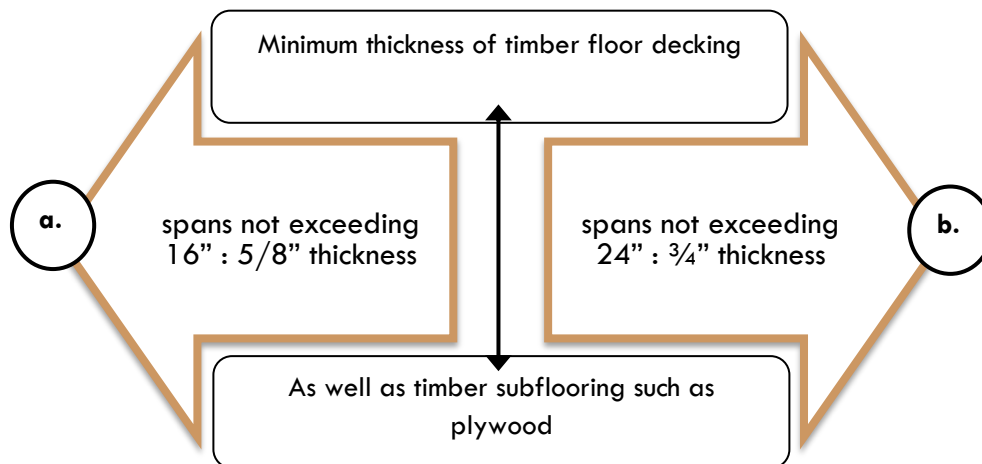

Figure 8-10 - Holes in Floor Joists



**8.4.13**      **TIMBER FLOOR DECKING**

The minimum thickness of timber floor decking and timber subflooring such as plywood shall be as follows:

- a) Spans not exceeding 16":  $\frac{5}{8}$ " thickness
- b) Spans not exceeding 24":  $\frac{3}{4}$ " thickness

Joints in sheet flooring shall be made over the supports. Where possible, sheet flooring shall be laid in complete sheets. Fastening of the sheet flooring shall be in accordance with Appendix B.

**8.5**              **FLOOR FINISH**

*All habitable and ancillary rooms* shall receive finished flooring surfaces. These surfaces shall be smooth, even and free from roughness. The finished surfaces may consist of concrete and timber floors, carpet, tile, timber decking or other *approved* surfaces.

## 9 MASONRY WALLS

### 9.1 GENERAL

Any condition not specifically covered by this chapter shall be designed, inspected and approved by a registered engineer prior to inspection by the Building Official.

### 9.2 CONSTRUCTION

Masonry shall comply with the requirements of Chapter 14. In addition the following conditions shall apply:

- a) walls shall be constructed of running bond masonry;
- b) masonry walls may be unfilled and reinforced unless noted otherwise;
- c) the minimum thickness of exterior masonry walls shall be 8";
- d) the minimum thickness of interior loadbearing walls shall be 6";
- e) the minimum thickness of interior non loadbearing masonry walls shall be 4";
- f) no masonry wall shall be of lesser thickness than the walls above it;
- g) allowance for moisture control for basement walls shall be provided; and
- h) unstorby rock cuts shall be faced with a masonry wall.

#### 9.2.1 UNIT MASONRY

##### 9.2.1.1 BED AND HEAD JOINTS

Unless otherwise required or indicated on the project drawings, head and bed joints shall be  $\frac{3}{8}$ " (10mm) thick, except that the thickness of the bed joint of the starting course placed over foundations shall not be less than  $\frac{1}{4}$ " (7mm) and not more than  $\frac{3}{4}$ " (19 mm).

##### 9.2.1.2 MASONRY UNIT PLACEMENT

The mortar shall be sufficiently plastic and units shall be placed with sufficient pressure to extrude mortar from the joint and produce a tight joint. Deep furrowing of bed joints that produces voids shall not be permitted. Any units disturbed to the extent that the initial bond is broken after initial placement shall be removed and re-laid in fresh mortar. Surfaces to be in contact with mortar shall be clean and free of deleterious materials.

##### 9.2.1.3 MASONRY LAID IN RUNNING BOND

In each wythe of masonry laid in running bond, head joints in successive courses shall be offset by not less than one-fourth the unit length.

### 9.3 LATERAL SUPPORT

#### 9.3.1 INTERNAL WALLS

Lateral supports to internal walls shall be provided, **either** in the vertical **or** horizontal direction, at right angles to the wall as per the following spacings (Table 9.1):

- a) Loadbearing walls: 15 times the nominal wall thickness
- b) Non loadbearing walls: 36 times the nominal wall thickness

a) Load bearing walls = 18 × nominal wall thickness

b) Non-Load bearing walls = 36 × nominal wall thickness

Horizontal support shall be deemed to be provided by connection of walls to floor or roof construction in accordance with section 9.3.3 Vertical support to walls shall be provided by intersecting walls, piers, or buttresses in accordance with section 9.3.4.

Nominal Wall Thickness	Maximum spacing for vertical or horizontal supports	
	Loadbearing Walls	Non –Loadbearing Walls
4"	N/A	12'-0"
6"	9'-0"	18'-0"
8"	12'-0"	24'-0"
10"	15'-0"	30'-0"
12"	18'-0"	36'-0"

Table 9.1 - Internal Walls: Maximum spacing between Lateral supports

**9.3.2 EXTERIOR WALLS**

For exterior walls the lateral supports shall be provided in both the vertical and horizontal directions as follows (Table 9.2):

- a) Vertical 15 times the nominal wall thickness
- b) Horizontal 30 times the nominal wall thickness

a) Vertical = 15 × nominal wall thickness;

Horizontal support shall be deemed to be provided by connection of walls to floor or roof construction in accordance with section 9.3.3. Lateral support to gable end walls can be provided

b) Horizontal = 30 × nominal wall thickness;

in the horizontal direction with a bond beam across the wall at eaves height in accordance with section 9.4.1. Vertical support to walls shall be provided by intersecting walls, piers or buttresses in accordance with section 9.3.4.



Nominal Wall Thickness	Maximum spacing between lateral supports	
	Loadbearing Walls	Non-Loadbearing Walls
8"	20'-0"	10'-0"
10"	25'-0"	12'-0"
12"	30'-0"	15'-0"

**Table 9.2 - Exterior Walls: Maximum spacing between Lateral Supports**

### 9.3.3 HORIZONTAL SUPPORT

Lateral support will be considered to have been provided to a wall in the horizontal direction when one of the following conditions is in full effect:

- a) A concrete slab is cast onto the wall with the minimum bearing in accordance with section 8.3.6.
- b) Timber stringers are used to support a timber floor as per section 8.4.8.
- c) Timber floor joists bear onto and are toe nailed to a timber bond plate seated on top of the masonry wall.
- d) A continuous bond beam is provided to the top of the wall (in accordance with section 9.4) which supports timber wall plate (in accordance with section 10.5) and a roof (in accordance with Chapter 10)
- e) A continuous bond beam is provided to a gable end wall in accordance with section 9.4.
- f) The wall is connected to a concrete slab or timber floor joists above by the use of metal brackets with **all** of the following minimum requirements:
  1. The brackets shall be a minimum size of 1/8" thick x 2" wide;
  2. The brackets shall be cast a minimum of 4" into a concrete bond beam on top of the wall;
  3. The brackets shall be fastened to the underside of the slab above with minimum two 1/2" diameter x 3" long expansion anchor bolts or to floor joists with two 1/2" diameter bolts;
  4. The Brackets shall have a maximum spacing of 4' centers;
  5. An 8" deep reinforced concrete bond beam shall be placed on top of the wall the same thickness at the wall below in accordance with section 9.4; or,
  6. The maximum distance from the top of the concrete belt to the underside of the concrete slab or timber joist shall be 6".

**NOTE:** On internal walls, lateral support in the horizontal direction is only necessary if vertical support is not provided in accordance with sections 9.3.1 and 9.3.4.

### 9.3.4 VERTICAL SUPPORT

Lateral support in the vertical direction to walls shall be considered to have been provided by intersecting masonry walls if all the following conditions are satisfied:

- a) the intersecting lateral support walls are a minimum of 6" thick masonry;
- b) the length of the intersecting lateral support wall shall be at least 1/4 of the average distance between lateral supports either side (i.e. the length of exterior wall contributing load to the lateral support wall);
- c) the intersecting walls shall be connected in accordance with section 9.3.5;
- d) the minimum length of lateral support walls shall be 16" whether grouted or not; and,

- e) the length of the lateral support walls shall be measured from the inside face of the wall that it supports.

**NOTE:** On internal wall, lateral support in the vertical direction is only necessary if horizontal support is not provided in accordance with sections 9.3.1 and 9.3.3.

### **9.3.5 CONNECTION OF INTERSECTING WALLS**

Connections shall be provided by one of the following methods:

- a) Fifty percent of the masonry units at the interface shall interlock for the full width of the wall;
- b) Intersecting bond beams at a maximum spacing of 4' centers. The bond beams shall be 8" deep and the same width as the wall below. They shall be reinforced with 2 T12mm (½") bars; or,
- c) Walls shall be anchored by steel connectors with the following minimum requirements:
  1. Minimum size 1/8" thick x 1 ½" wide x 24" long with 2" long 90 degree bends, either end.
  2. Maximum vertical spacing 4'0".
  3. All cells containing these connectors shall be grouted.

Connection to existing walls shall be achieved by way of a minimum 3" deep chase into the existing masonry Bermuda stone wall.

### **9.3.6 WALLS SUPPORTED AT ONE END ONLY**

Where an internal wall is provided with vertical support on only one end by an intersecting wall, the length of the wall shall be no more than 15 times the wall thickness. In addition the walls shall be capped with a bond beam in accordance with section 9.4. In addition, the height of the wall shall not exceed 8' unless it has adequate horizontal connections at the top of the wall in accordance with section 9.3.3.

NOTE: The following methods are all acceptable means of achieving horizontal lateral support to masonry walls as per section 9.3.3  
 Support distances must not exceed those given in Tables 9.1 and 9.4

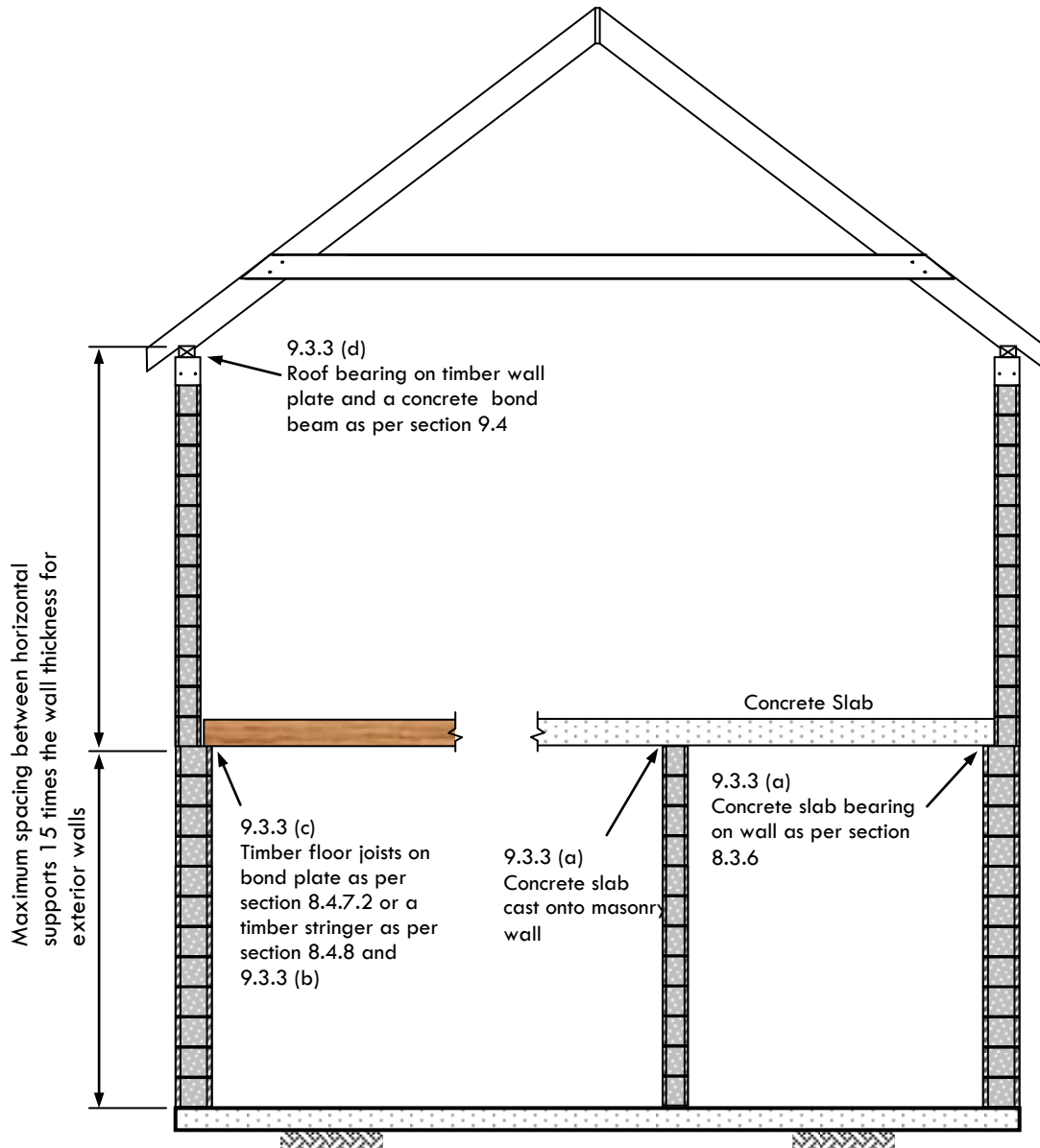

Figure 9.1 - Acceptable Means of Providing Horizontal Supports to Masonry Walls

NOTE: Horizontal support to internal walls is ONLY required when vertical support is NOT provided in accordance with sections 9.3.1 and 9.3.4

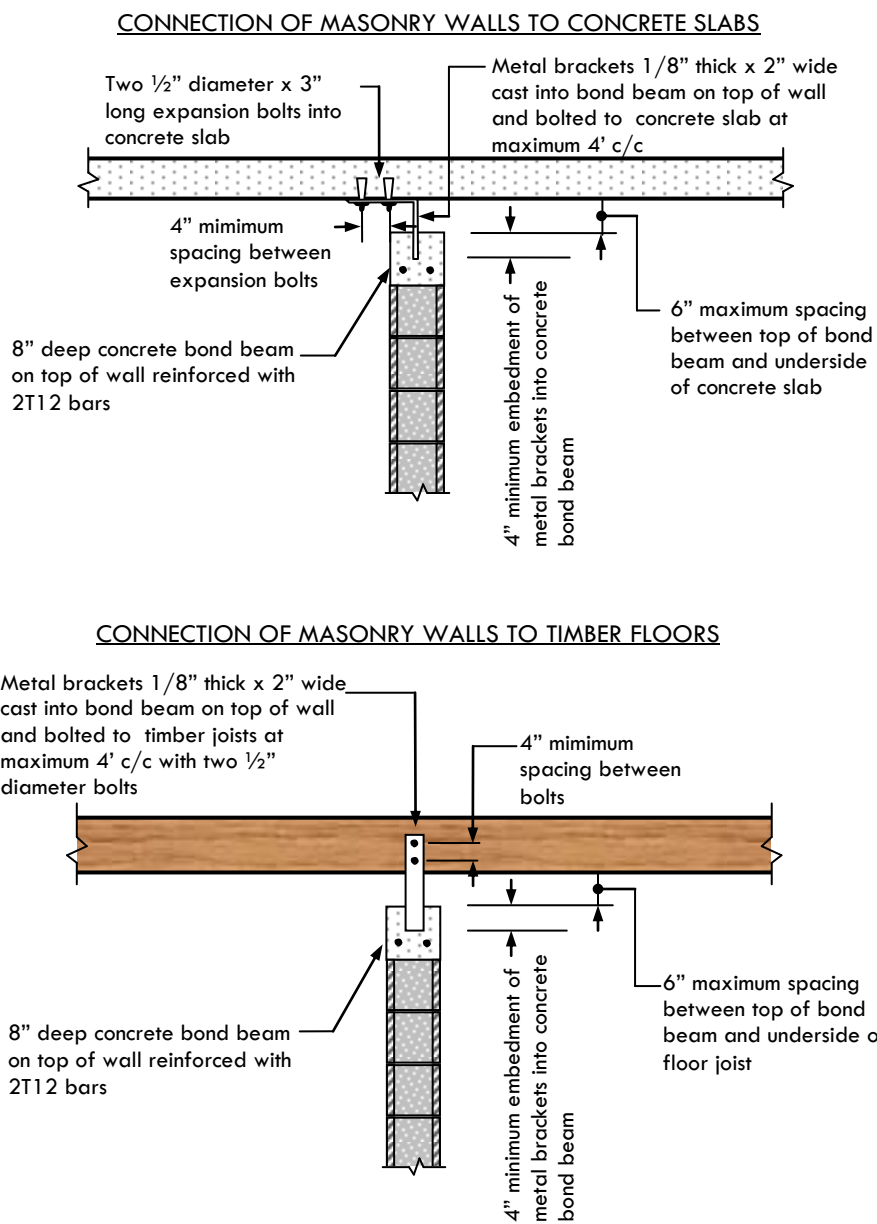

Figure 9.2 - Alternative Methods of Providing Horizontal Supports to Masonry Walls

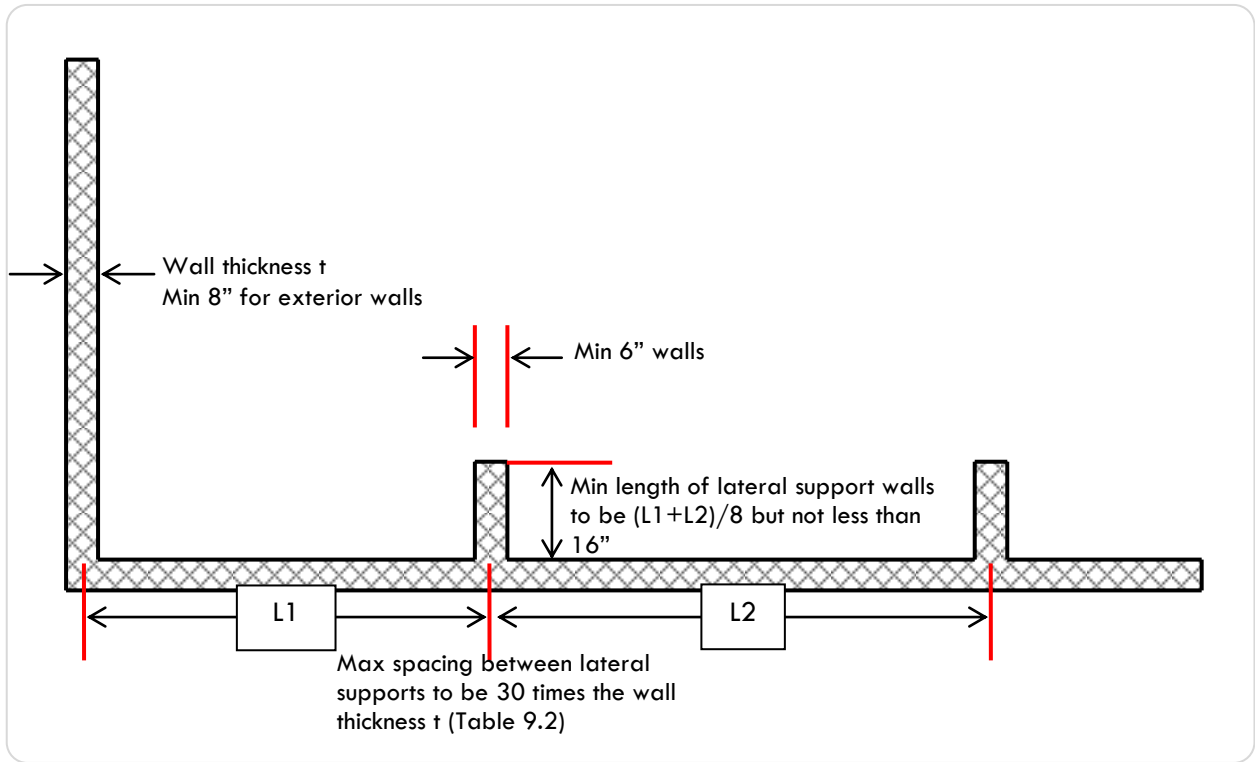

Figure 9-3 - Minimum length of Lateral Support Walls

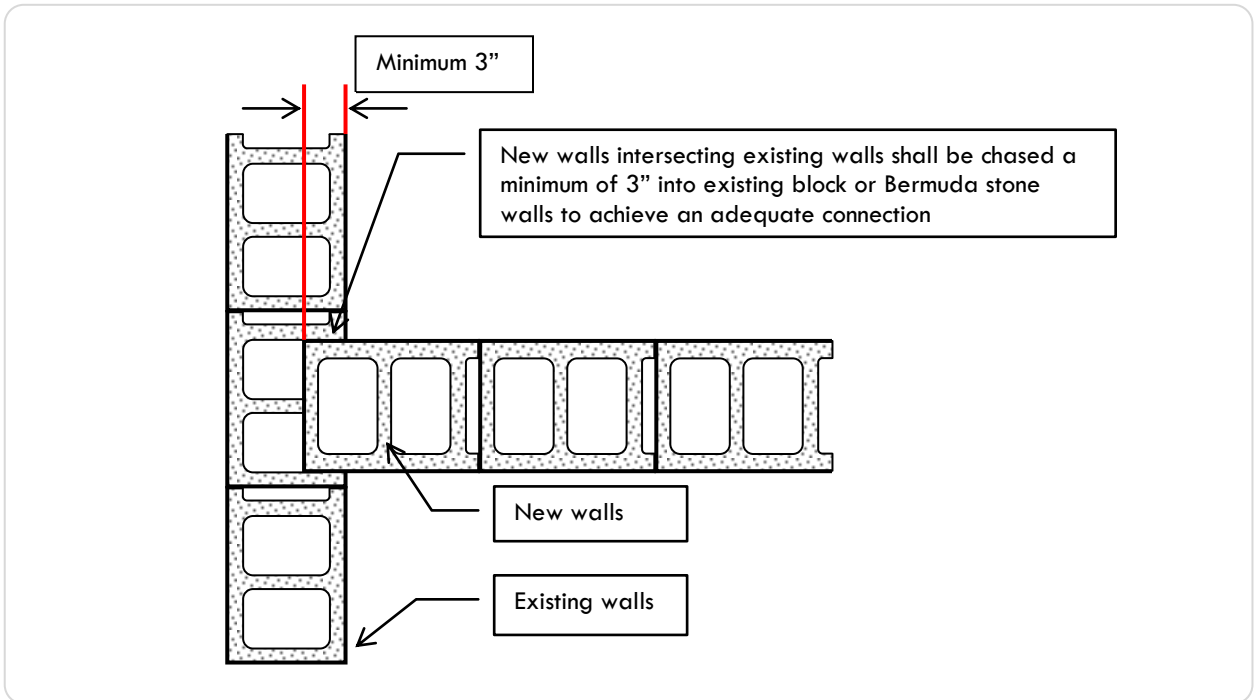
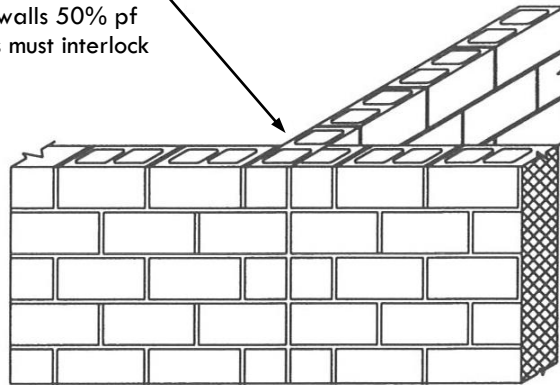
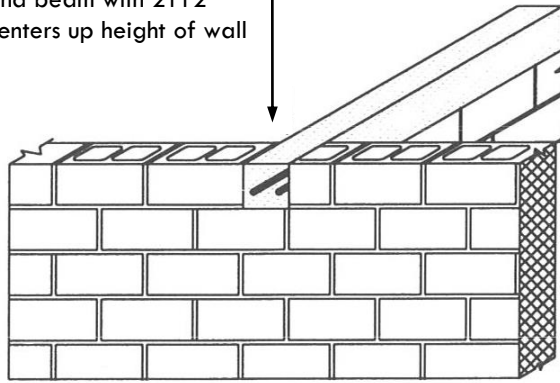

Figure 9.4 - Connection to Existing Walls

Connection Detail 9.3.5 (a)  
 Running Bond lap at  
 intersection of walls 50% pf  
 masonry blocks must interlock



Alternative Connection Detail 9.3.5 (b)  
 8" Deep bond beam with 2T12  
 bars at 4' centers up height of wall



Alternative Connection Detail 9.3.5 (c)  
 Metal strap connectors of 1/8" thick steel  
 placed at max 4' centres up height of wall  
 All cells containing metal connectors must  
 be concrete filled

Cells to be filled

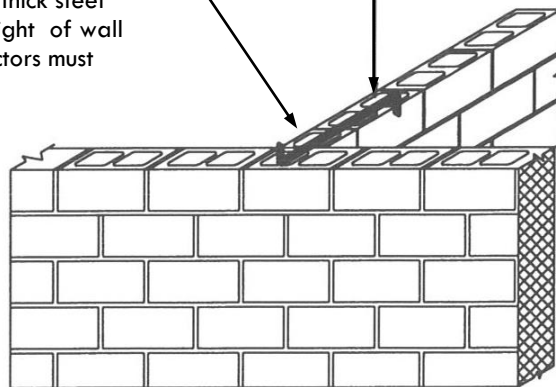
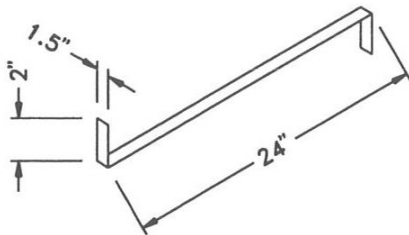

Figure 9.5 - Connection of Intersecting Walls

## 9.4 BOND BEAMS

### 9.4.1 EXTERIOR WALLS

Concrete bond beams shall be provided on the top of all walls. These shall be a minimum 8" deep and the same width as the wall itself. They shall be reinforced with a minimum of 2 T12mm diameter bars continuous throughout the bond beam. The minimum lap length of these bars shall be as per Table 13.2, including the corners of intersecting walls. In addition, the bars shall be placed approximately half way up the bond beam. Where openings are placed directly under the bond beam, the bond shall be reinforced as a lintel in accordance with section 9.7, but in no cases, shall the minimum reinforcement of 2 T12 bars be reduced. Tie and secure rebar in desired position to maintain concrete cover.

### 9.4.2 INTERNAL WALLS

Bond beams shall also be extended over internal walls in order to adequately tie all the walls of the building together.

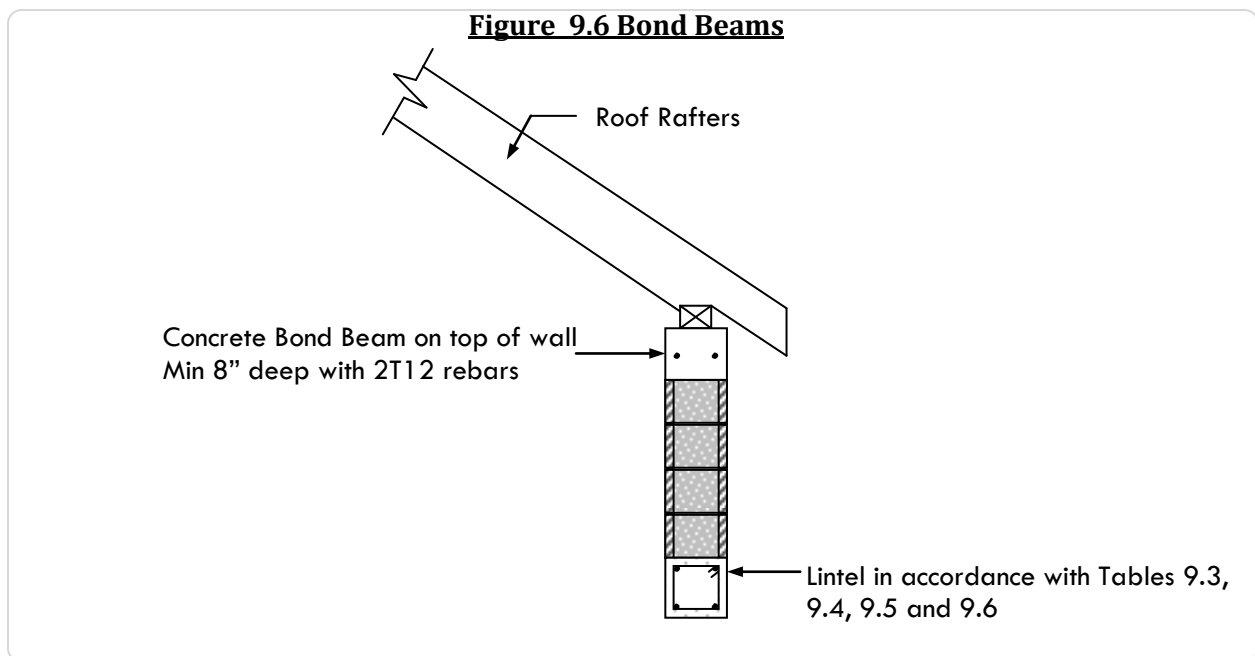

Figure 9.6 - Bond Beams

## 9.5 OPENINGS IN WALLS

### 9.5.1 LINTELS

All wall openings greater than 12" wide shall have a lintel over, in accordance with section 9.7.

### 9.5.2 VERTICAL CELLS

Wall openings of 6' in width or greater in exterior walls shall have the vertical cells either side solid filled down to the floor below. For openings greater than 8' in width, the cell either side shall be reinforced with 1 T12mm diameter rod from the floor below to the floor or bond beam above.

**9.5.3 SILL**

Window openings greater than 8' in width shall have a reinforced concrete sill placed underneath them to the following minimum requirements:

- a) The sill shall be a minimum of 4" deep and the width of the wall below.
- b) The sill shall be reinforced by 2 T12mm diameter rods with 1½" cover either side.
- c) The sill shall extend a minimum of 8" beyond each end of the window.

**9.5.4 WIDTH**

The maximum width of an opening in an exterior wall shall not exceed 12' without calculation from a registered engineer. Exception: Unenclosed porch walls.

**9.5.5 MAXIMUM AMOUNT OF OPENINGS**

The maximum percentage of openings in any exterior wall, when cutting a horizontal plane through any point of the wall, shall be 60% of the wall length.

**9.5.6 SPACING OF OPENING**

The minimum horizontal distance between openings less than 4' width shall be 16". The minimum horizontal distance between openings greater than 4' in width shall be 32". Openings shall be at least 16" from an external corner.

**9.6 CHASES AND RECESSES**

Masonry directly above chases or recesses wider than 12" shall be supported by lintels in accordance with section 9.7. Chases and recesses in masonry walls shall not be deeper. Please refer to R606.7 of the IRC 2012. Please seek advice from an engineer for chases in concrete columns only.

**9.7 LINTELS****9.7.1 CONSTRUCTION**

Reinforced concrete cast in place lintels shall be provided in accordance with Tables 9.3, 9.4, 9.5, & 9.6. Lintels of greater span or outside the scope of those provided in the tables shall be designed by a registered engineer.

**9.7.2 BEARING**

Lintels shall bear a minimum of 8" onto masonry walls either side. For openings of 6' or greater the cells either side of the opening shall be solid filled to the floor below.

**9.7.3 CONCRETE**

All concrete work shall be in accordance with Chapter 13.



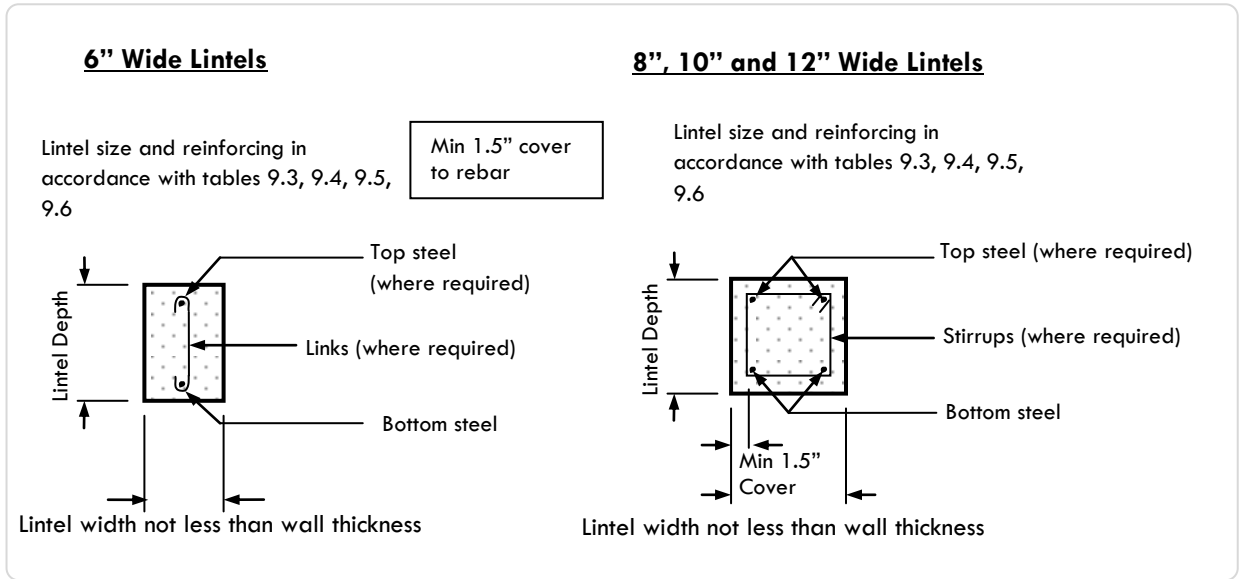

Figure 9.7 - Lintels

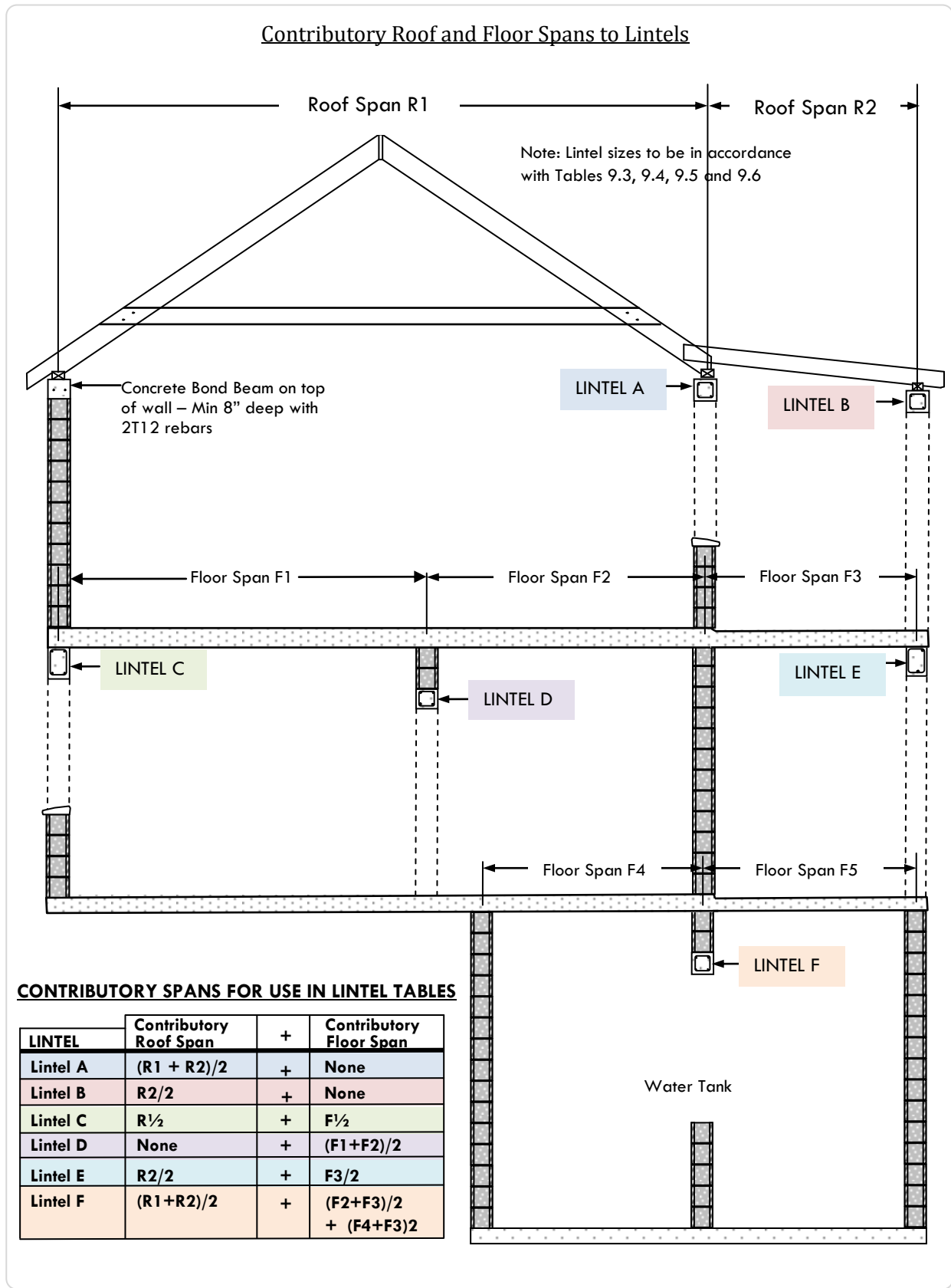

Figure 9-8 - Contributory Roof and Floor Spans to Lintels

Lintels Sizes: Supporting Roof ONLY (up to 20' span)						
Width of Wall	Depth of Lintel	Reinforcing required for span up to:				
		4'	6'	8'	10'	12'
6" Wall	8"	1T10	1T16	1T20 bot 1T12 top T6@4"c/c	N/A	N/A
	10"	1T12	1T12	1T16 bot 1T12 top T6@5"c/c	N/A	N/A
	12"	1T12	1T12	1T16	1T20 bot 1T12 top T6@6"c/c	N/A
	16"	1T16	1T16	1T16	1T16	1T20 bot 1T12 top T6@8"c/c
8" Wall	8"	2T10	2T12	2T16	2T20 bot 2T12 top T6@4"c/c	N/A
	10"	2T10	2T12	2T12	2T16 bot 2T10 top T6@5"c/c	2T20 bot 2T12 top T6@5"c/c
	12"	2T12	2T12	2T12	2T12	2T16
	16"	2T12	2T12	2T12	2T12	2T12
10" Wall	8"	2T10	2T12	2T16	2T20 bot 2T12 top T6@4"c/c	N/A
	10"	2T10	2T12	2T12	2T16	2T20 bot 2T12 top T6@12"c/c
	12"	2T12	2T12	2T12	2T12	2T16
	16"	2T16	2T16	2T16	2T16	2T16
12" Wall	8"	2T12	2T12	2T12	2T20	N/A
	10"	2T12	2T12	2T12	2T16	2T20 bot 2T12 top T6@12"c/c
	12"	2T12	2T12	2T12	2T12	2T16
	16"	2T16	2T16	2T16	2T16	2T16

Table 9.3 - Lintels Sizes: Supporting Roof ONLY (up to 20' span)

**Note:**

1. The span is defined as the average of the spans of members (floor or roof members) on each side of the lintel and contributing load to it.
2. Where only one figure is displayed this represents the reinforcing to be placed in the bottom of the lintel, with 1 ½" cover from the bottom.
3. The lower figure in each box represents the size of the links (stirrups) and their maximum allowable spacing on centres. Where two or more longitudinal bars are required on the bottom of the lintel, the stirrup shall have 2 legs.
4. N/A stands for Not Applicable, meaning that the use of this type of lintel is not applicable for the application intended.
5. Where the lintels are part of a bond beam, the minimum reinforcement of 2T12 bars in accordance with section 9.4.1 shall apply.
6. Refer to Table 13.3 for equivalent imperial bar sizes to the metric reinforcing designated in the Table.

**Lintels Sizes: Supporting Floor ONLY (spans up to 10') or Roof ONLY (spans up to 30') OR Floor (up to 8' span) AND Roof (up to 8' span)**

Width of Wall	Depth of Lintel	Reinforcing required for span up to;				
		4'	6'	8'	10'	12'
6" Wall	8"	1T12	1T20 bot 1T12 top T6@4"c/c	N/A	N/A	N/A
	10"	1T12	1T16 bot 1T10 top T6@4"c/c	N/A	N/A	N/A
	12"	1T12	1T16	2T12 bot 2T10 top T6@6"c/c	N/A	N/A
	16"	1T16	1T16	1T16	1T20 bot 1T12 top T6@8"c/c	N/A
8" Wall	8"	2T10	2T12 bot 2T10 top T6@4"c/c	2T20 bot 2T12 top T6@4"c/c	N/A	N/A
	10"	2T10	2T12	2T16 bot 2T10 top T6@5"c/c	2T20 bot 2T12 top T6@5"c/c	N/A
	12"	2T12	2T12	2T12	2T16 bot 2T10 top T6@6"c/c	2T20 bot 2T12 top T6@6c/c
	16"	2T12	2T12	2T12	2T12	2T16
10" Wall	8"	2T10	2T12	2T20 bot 2T12 top T6@4c/c	N/A	N/A
	10"	2T12	2T12	2T16	2T20 bot 2T10 top T6@5"c/c	N/A
	12"	2T12	2T12	2T12	2T16	2T20 bot 2T12 top T6@6"c/c
	16"	2T16	2T16	2T16	2T16	2T16
12" Wall	8"	2T12	2T12	2T16 bot 2T10 top T6@4"c/c	3T20 bot 2T16 top T6@4"c/c	N/A
	10"	2T12	2T12	2T16	2T20 bot 2T12 top T6@5"c/c	N/A
	12"	2T12	2T12	2T12	2T16	2T20
	16"	2T16	2T16	2T16	2T16	2T16

**Table 9.4 - Lintels Sizes: Supporting Floor ONLY (spans up to 10') or Roof ONLY (spans up to 30') OR Floor (up to 8' span) AND Roof (up to 8' span)**

Notes:

1. The span is defined as the average of the spans of members (floor or roof members) on each side of the lintel and contributing load to it.
2. Where only one figure is displayed this represents the reinforcing to be placed in the bottom of the lintel, with 1 ½" cover from the bottom.
3. The lower figure in each box represents the size of the links (stirrups) and their maximum allowable spacing on centres. Where two or more longitudinal bars are required on the bottom of the lintel, the stirrup shall have 2 legs.
4. N/A stands for Not Applicable, meaning that the use of this type of lintel is not applicable for the application intended.
5. Where the lintels is part of a bond beam, the minimum reinforcement of 2T12 bars in accordance with section 9.4.1 shall apply.
6. Refer to Table 13.3 for equivalent imperial bar sizes to the metric reinforcing designated in the Table.

Lintels Sizes: Supporting Roof ( up to 15' span) AND Floor (up to 10' span) or Floor ONLY (up to 15' span)						
Width of Wall	Depth of Lintel	Reinforcing required for span up to;				
		4'	6'	8'	10'	12'
6" Wall	8"	1T16 bot 1T10 top T6@4"c/c	2T16 bot 2T10 top T6@4"c/c	N/A	N/A	N/A
	10"	1T12 bot 1T10 top T6@5"c/c	1T20 bot 1T12 top T6@5"c/c	N/A	N/A	N/A
	12"	1T12	1T16 bot 1T10 top T6@6"c/c	N/A	N/A	N/A
	16"	1T16	1T16	1T20 bot 1T12 top T6@8"c/c	N/A	N/A
8" Wall	8"	2T10 bot 2T10 top T6@4"c/c	2T16 bot 2T10 top T6@4"c/c	N/A	N/A	N/A
	10"	2T10	2T16 bot 2T10 bot T6@5"c/c	2T20 bot 2T12 top T6@5"c/c	N/A	N/A
	12"	2T12	2T12	2T16 bot 2T10 top T6@6"c/c	3T16 bot 2T12 top T6@6"c/c	N/A
	16"	2T12	2T12	2T16	2T16 bot 2T10 top T6@8"c/c	2T20 bot 2T12 top T6@8"c/c
10" Wall	8"	2T10	2T16 bot 2T10 top T6@4"c/c	N/A	N/A	N/A
	10"	2T12	2T16 bot 2T10 top T6@5"c/c	2T20 bot 2T12 top T6@5"c/c	3T20 bot 2T16 top T6@5"c/c	N/A
	12"	2T12	2T12	2T16 bot 2T10 top T6@6"c/c	2T20 bot 2T12 top T6@6"c/c	N/A
	16"	2T16	2T16	2T16	2T16 bot 2T10 top T6@8"c/c	2T20 bot 2T12 top T6@8"c/c
12" Wall	8"	2T12	2T16 bot 2T10 top T6@4"c/c	3T20 bot 2T16 top T6@4"c/c	N/A	N/A
	10"	2T12	2T16	2T20 bot 2T12 top T6@5"c/c	3T20 bot 2T16 top T6@5"c/c	N/A
	12"	2T12	2T12	2T16	2T20 bot 2T12 top T6@6"c/c	3T20 bot 2T12 top T6@6"c/c
	16"	2T16	2T16	2T16	2T16 bot 2T10 top T6@8"c/c	2T20 bot 2T12 top T6@4"c/c

Table 9.5 - Lintels Sizes: Supporting Roof (up to 15' span) AND Floor (up to 10' span) or Floor ONLY (up to 15' span)

Notes:

1. The span is defined as the average of the spans of members (floor or roof members) on each side of the lintel and contributing load to it.
2. Where only one figure is displayed this represents the reinforcing to be placed in the bottom of the lintel, with 1 ½" cover from the bottom.
3. The lower figure in each box represents the size of the links (stirrups) and their maximum allowable spacing on centres. Where two or more longitudinal bars are required on the bottom of the lintel, the stirrup shall have 2 legs.
4. N/A stands for Not Applicable, meaning that the use of this type of lintel is not applicable for the application intended.
5. Where the lintels are part of a bond beam, the minimum reinforcement of 2T12 bars in accordance with section 9.4.1 shall apply.
6. Refer to Table 13.3 for equivalent imperial bar sizes to the metric reinforcing designated in the Table.



**Lintels Sizes: Walls Supporting: Roof ( up to 20' span) AND Floor (up to 15' span) OR Floor ONLY (up to 25' span)**

Width of Wall	Depth of Lintel	Reinforcing required for span up to;				
		4'	6'	8'	10'	12'
6" Wall	8"	N/A	N/A	N/A	N/A	N/A
	10"	1T16 bot 1T10 top T6@5"c/c	N/A	N/A	N/A	N/A
	12"	1T16 bot 1T10 top T6@6"c/c	N/A	N/A	N/A	N/A
	16"	1T16	1T20 bot 1T12 top T6@6"c/c	N/A	N/A	N/A
8" Wall	8"	2T16 bot 2T10 top T6@4"c/c	N/A	N/A	N/A	N/A
	10"	2T12 bot 2T10 top T6@5"c/c	2T20 bot 2T12 top T6@5"c/c	N/A	N/A	N/A
	12"	2T12 bot 2T10 top T6@6"c/c	2T16 bot 2T10 top T6@6"c/c	3T20 bot 2T16 top T6@4"c/c	N/A	N/A
	16"	2T12	2T12 bot 2T10 top T6@8"c/c	2T20 bot 2T12 top T6@6"c/c	3T20 bot 2T12 top T6@6"c/c	N/A
10" Wall	8"	2T16 bot 2T10 top T6@4"c/c	N/A	N/A	N/A	N/A
	10"	2T12 bot 2T10 top T6@5"c/c	2T20 bot 2T12 top T6@5"c/c	N/A	N/A	N/A
	12"	2T12	2T16 bot 2T10 top T6@6"c/c	3T16 bot 2T10 top T6@4"c/c	N/A	N/A
	16"	2T16	2T16	2T16 bot 2T10 top T6@8"c/c	3T20 bot 2T12 top T6@6"c/c	N/A
12" Wall	8"	2T16 bot 2T10 top T6@4"c/c	N/A	N/A	N/A	N/A
	10"	2T12	2T20 bot 2T12 top T6@5"c/c	N/A	N/A	N/A
	12"	2T12	2T16 bot 2T10 top T6@6"c/c	3T16 bot 2T10 top T6@6"c/c	N/A	N/A
	16"	2T16	2T16	2T16 bot 2T10 top T6@8"c/c	3T20 bot 2T12 top T8@8"c/c	N/A

**Table 9.6 - Lintels Sizes: Walls Supporting: Roof (up to 20' span) AND Floor (up to 15' span) OR Floor ONLY (up to 25' span)**

Notes:

1. The span is defined as the average of the spans of members (floor or roof members) on each side of the lintel and contributing load to it.
2. Where only one figure is displayed this represents the reinforcing to be placed in the bottom of the lintel, with 1 ½" cover from the bottom.
3. The lower figure in each box represents the size of the links (stirrups) and their maximum allowable spacing on centres. Where two or more longitudinal bars are required on the bottom of the lintel, the stirrup shall have 2 legs.
4. N/A stands for Not Applicable, meaning that the use of this type of lintel is not applicable for the application intended.
5. Where the lintels are part of a bond beam, the minimum reinforcement of 2T12 bars in accordance with section 9.4.1 shall apply.
6. Refer to Table 13.3 for equivalent imperial bar sizes to the metric reinforcing designated in the Table.

---

## **10 ROOFS**

---

### **10.1 GENERAL**

Roofs shall be identified as either lightweight or heavyweight roofs. Roof pitches shall not be less than 5 in 12 (22.6 degrees) or greater than 10 in 12 (39.8 degrees) for the main roof. The main roof shall be constructed of a coupled collar tie roof. Shallow monopitch roofs (herein referred to as flat roofs) over areas such as porches shall be not less than 1 in 12 (4.8 degrees) or greater than 3 in 12 (14 degrees), and may be constructed with simple span rafters. All timber shall be in accordance with Chapter 15. Any conditions not specifically covered by this chapter shall be designed, inspected and approved by a registered engineer prior to inspection by the Building Official.

### **10.2 PITCHED ROOFS**

#### **10.2.1 GENERAL**

All pitched roofs referred to in this code, except flat roofs detailed in Tables 10.3, 10.4 and 10.5 shall be constructed of rafters with coupled collar ties.

#### **10.2.2 CONSTRUCTION METHOD**

The rafters shall attach to a ridge board in accordance with section 10.2.6 and shall be placed directly opposite each other. Collar ties shall be placed at either the wall plate level, one-third the height of the roof or one-half the height of the roof. In no circumstances shall the collar ties be placed higher than one-half the roof height. The size of the rafters, collar ties and connections shall be in accordance with tables 10.6, 10.7, 10.8, 10.9, 10.10 and 10.11. The rafter and collar tie spacings shall be 16" on centre for Bermuda slate roofs and 24" on centre for lightweight roofs.

#### **10.2.3 RAFTER CONNECTIONS**

Rafters shall have a birdsmouth connection to the wall plate. The depth of the notch in the rafter to form the birdsmouth shall not exceed one-fifth the depth of the member. In addition, the rafters shall be connected in accordance with Appendix B and Table 10.1.

#### **10.2.4 COLLAR TIE SPANS**

Collar ties may span the full distance between rafters or be supported at midspan by suspending from the ridge plate with a vertical 2"x 4" timber.

#### **10.2.5 FLAT ROOFS**

Single slope roofs shall be permitted as described in section 10.1. They shall be in accordance with Tables 10.3, 10.4 and 10.5. The rafter spacings shall be 16" on centre for Bermuda slate roofs and 24" on centre for lightweight roofs. The rafters shall be connected in accordance with Appendix B and hurricane clip connectors shall be provided in accordance with Tables 10.1. and 10.2.

#### **10.2.6 RIDGE BOARDS**

Ridge boards shall be constructed of 1" wide timber and the depth shall be the same depth as that of the cut end of the rafters.

**10.2.7 HIP RAFTERS**

Hip Rafters shall be 2" thick and the same depth as the main roof rafters. Hip rafters spanning greater than 20' shall consist of double rafters the same depth as the main roof rafters. Hip rafters shall not cantilever more than 24" over the support.

**10.2.8 VALLEY RAFTERS**

Valley rafters shall be 2" thick and the same depth as the cut end of the main roof framing rafters for spans up to 16'. For spans greater than 16' they shall consist of double rafters the same depth as the cut end of the roof framing rafters.

Exception: Where it is not possible to obtain valley rafters the same depth as the cut ends of the rafters they support, for 10" and 12" deep rafters, the valley rafters shall consist of double rafters the same depth as the rafters they support for spans up to 16' and triple rafters beyond.

**10.3 JOINTS IN ROOF FRAMING MEMBERS**

Joints are only permitted (except for ridge boards and laths) over supports, but not where the member is cantilevered over the support. Joints shall be lapped a distance not less than the depth of the member and shall be nailed with two 16d nails either side.

**10.4 BEARING**

The ends of each rafter shall have a minimum of 1½" bearing onto a timber plate.

**10.5 TIMBER WALL PLATES**

These shall be 4" wide and 3" high timbers set on top of the concrete bond beam of a masonry wall. Wall plates shall be preservative treated to a minimum of 0.25lb/ft<sup>3</sup> CCA.

**10.6 ANCHOR BOLTS**

These shall be used for all lightweight roofs of less than 26lbs/ft<sup>2</sup> dead load and also for unenclosed flat roofs comprised of Bermuda slate construction. The installation of these anchor bolts shall be as follows:

- a) Anchor bolts shall be ½" diameter located within 12" of the end of each section of wall plate, thereafter at 48" c/c maximum spacing;
- b) They shall have a 2" bend on the base, or alternatively a 2" diameter washer and be cast a minimum of 4" into the concrete bond beam; and,
- c) The wall plate shall be fastened to the anchor bolts using a nut with a washer of minimum size 1½" diameter and 1/8" thick.

**10.7 OVERHANGS**

Rafters or false rafter feet shall not overhang a distance greater than 18" beyond the face of the wall for pitched roofs or 12" for flat roofs.

**10.8 FALSE RAFTER FEET**

Where used, rafter feet shall be no smaller than 4"x3" timbers and shall be connected to the main roof rafters by one of the following means:

- a) bolted to the side of the rafters using ½" diameter bolts set a minimum of 4" apart; or
- b) the bottom surface of the false rafter feet bevelled and nailed to the top of the rafter using two pairs of nails set a minimum of 6" apart. The nails shall be 20d (4") common nails and shall penetrate a minimum of 2 ½" into the rafters.

**10.9 HURRICANE CLIPS**

Lightweight roofs and unenclosed flat roofs comprised of either Bermuda slate and lightweight construction shall have the rafters connected to the wall plate with hurricane clips. This shall apply for both interior and exterior walls. The hurricane clips shall provide a minimum allowable uplift resistance per rafter connection under wind load conditions in accordance with Tables 10.1 and 10.2. Specification sheets of the proposed hurricane clips shall be submitted to the Building Official for approval.

**Minimum Allowable Capacity of Hurricane Clips for Lightweight Pitched Roofs & Lightweight Fully Enclosed Flat Roofs**

Span of Roof (feet)	Minimum Allowable Uplift Capacity of Hurricane Clip (9lbs)
8'	500
10'	575
12'	650
14'	725
16'	800
18'	875
20'	950
22'	1025
24'	1100
26'	1200

Table 10.1 - Minimum Allowable Capacity of Hurricane Clips for Lightweight Pitched Roofs & Lightweight Fully Enclosed Flat Roofs

**Note:**

1. For rafters bearing on interior walls, the values in Table 10.1 may be reduced by 200 lb per rafter connection.
2. Fully enclosed flat roofs shall be taken to mean that there are no permanent wall openings that cannot be closed by the use of doors or windows.
3. The span is defined as the horizontal distance between the centre of supports.

**Minimum Allowable Capacity of Hurricane Clips for Flat Unenclosed Porch Roofs**

Span of Roof (feet)	Maximum Allowable Uplift of Hurricane Clip (lbs)	
	Bda Slate Roof: Rafter spacing 16"	Lightweight Roof: Rafter spacing 24"
8'	300	500
10'	325	575
12'	350	650
14'	375	725
16'	400	800
18'	425	875
20'	450	950

Table 10.2 - Minimum Allowable Capacity of Hurricane Clips for Flat Unenclosed Porch Roofs

**Note:** For rafters bearing on interior walls, the values in Table 10.2 may be reduced by 200 lb per rafter connection.

**10.10 ROOF VENTILATION****10.10.1 ROOF VENTS**

All roofs (light and heavy weight) shall have ventilation. The only exception will be determined by roof space that acts as a plenum.

Minimum openings of 4" wide x 1½" deep roof vents shall be provided at 6' centres for pitched roofs with suspended ceilings. These vents shall be located approximately 2' from the ridge line. A continuous air gap of approximately 1/8" shall also be installed under the eaves between the beam fill (between rafters) and roofing.

**10.10.2 GABLE ENDS**

Gable end walls shall receive roof ventilation at a minimum of 0.5% of the face area of gable end wall above the ceiling level. Alternatively, the gable end roof vents may be omitted if the number of roof vents in the pitched portion of the roof is increased by closing up their spacing to 4' centres.

**10.10.3 ATTIC ACCESS**

A readily accessible attic access framed opening not less than 22"x30" shall be provided to any attic having a clear height of greater than 30" above the ceiling.

**10.11 BERMUDA SLATE ROOF CONSTRUCTION**

Slated roofs are to be formed of 18"x12"x1" thick stone slates lapped 9". Eave slates are to be formed with 18"x12" precast concrete slates tapering to ½" with a triangular notch to receive the lowest tiling lath formed 2½" from the eaves edge of the tile. The eave slate should be screwed to the lowest lath with 2 brass or stainless steel screws per slate. Gutter stones of 3"x4" triangular Bermuda stone or precast concrete shall be set on roofs to convey rainwater to rainwater pipes. The whole roof shall be bedded in cement mortar and upon completion, given 2 coats of cement wash and painted with an approved coating in accordance with section 10.13.

**10.12 LIGHTWEIGHT ROOF CONSTRUCTION**

Only roof systems approved by the Building Official shall be used, and installation shall be strictly in accordance with the manufacturers' specifications.

**10.13 COATING**

Roofs shall be coated only by a product which is on the Department of Health's current list of Approved Roof Paints and Sealers.

**10.14 INSULATION**

The installation of insulation material within floor-ceiling assemblies, roof-ceiling assemblies, wall assemblies, crawl spaces and attics is not a requirement of this code. However, the traditionally constructed Bermuda homes have generally provided relatively poor insulation and the use of insulating materials is encouraged for energy conservation purpose. Where insulation is used it shall have a flame spread rating not to exceed 25 and a smoke developed rating not to exceed 50 when tested in accordance with ASTM E 84.

**10.15 ROOF REPLACEMENT FOR LISTED BUILDINGS**

Where the replacement of a roof on a historic building is required, every effort should be made to retain the original proportions of windows to eaves. Adding a new reinforced concrete roof/wall plate has the undesirable effect of raising the eaves far above the tops of the windows. This creates a detrimental visual impact to the building's elevation. A wooden roof/wall plate solution designed by a registered engineer is still acceptable, subject to the approval of the Building Official.



*Stewart Hall in St George's has had a wooden roof/wall plate for almost 300 years*

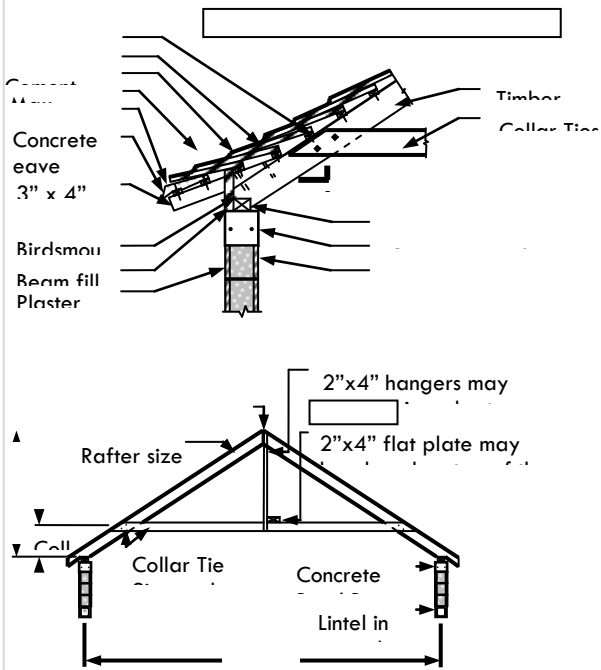
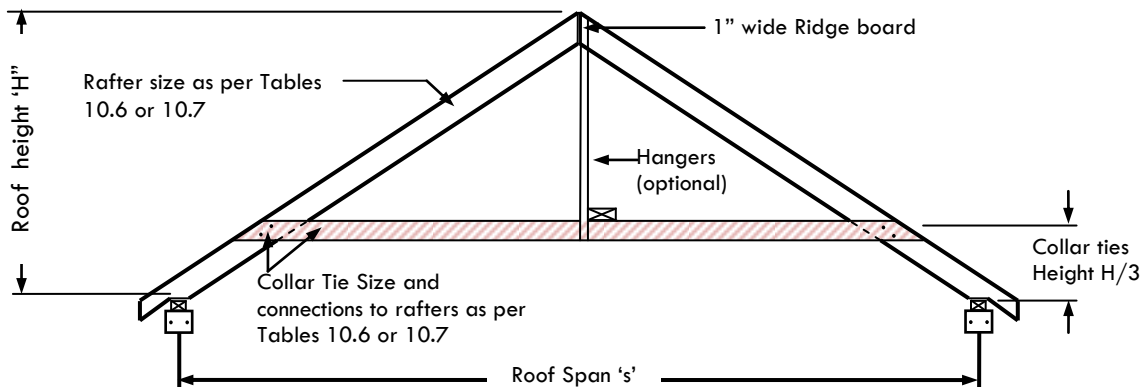

Figure 10-1 – Typical Roof Construction Details



**Optional Collar Tie Locations**



**COLLAR TIE AT ONE THIRD ROOF HEIGHT ( $H/3$ ) - TABLES 10.6 AND 10.7 APPLY**

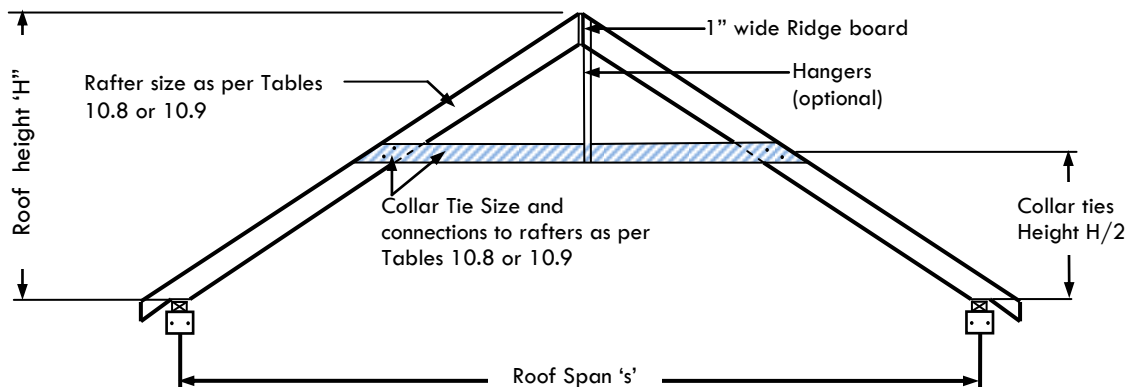

**COLLAR TIE AT ONE HALF ROOF HEIGHT ( $H/2$ ) - TABLES 10.8 AND 10.9 APPLY**

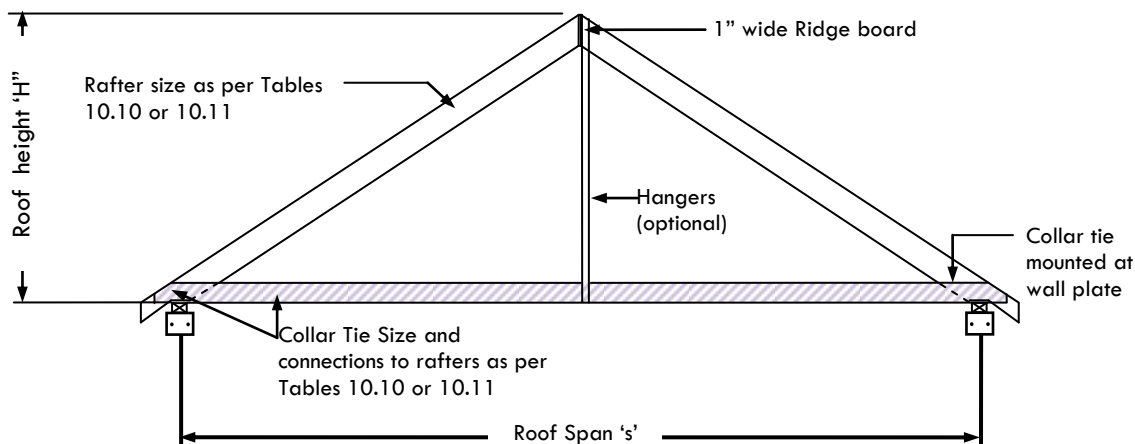

**COLLAR TIE AT WALL PLATE LEVEL - TABLES 10.10 AND 10.11 APPLY**

Figure 10-2 – Optional Collar Tie Locations

**FLAT ROOF CONSTRUCTION****Minimum Size of Rafters for Flat Roofs**

Span of Rafters	Minimum Rafter size for Bda Slate Roofs: Rafter spacing 16" c/c	Minimum Rafter size for Lightweight Roofs: Rafter spacing 24" c/c
8'	2x6	2x4
10'	2x6	2x6
12'	2x8	2x6
14'	2x8	2x8
16'	2x8	2x8
18'	2x10	2x8
20'	2x12	2x10

**Table 10.3 - Minimum Size of Rafters for Flat Roofs**

**Note:** A flat roof is defined as a shallow monopitched roof with a slope of not less than 1 in 12 or greater than 3 in 12.

**Minimum Connection Details for Rafters of Bda Slate Flat Roofs (Rafter spacing 16")**

Span of Rafters (feet)	Connection of Stringer to Wall	Minimum Allowable dead Load Capacity of Rafter Connection to Stringer (lbs)	Connection of Flat Roof Rafters to Main Roof Rafters
8'	1/2" bolts at 3' c/c	400	1 x 3/8" bolt
12'	5/8" bolts at 3' c/c	500	1 x 1/2" bolt
16'	5/8" bolts at 2'6" c/c	600	1 x 1/2" bolt
20'	5/8" bolts at 2' c/c	700	1 x 5/8" bolt

**Table 10.4 - Minimum Connection Details for Rafters of Bda Slate Flat Roofs****Minimum Connection Details for Rafters of Lightweight Flat Roofs (Rafter spacing 24")**

Span of Rafters (feet)	Connection of Stringer to Wall	Minimum Allowable dead Load Capacity of Rafter Connection to Stringer (lbs)	Connection of Flat Roof Rafters to Main Roof Rafters
8'	1/2" bolts at 5' c/c	200	1 x 3/8" bolt
12'	1/2" bolts at 4' c/c	300	1 x 3/8" bolt
16'	5/8" bolts at 4' c/c	400	1 x 1/2" bolt
20'	5/8" bolts at 3' c/c	500	1 x 1/2" bolt

**Table 10.5 - Minimum Connection Details for Rafters of Lightweight Flat Roofs**

**Notes (for Tables 10.3, 10.4 and 10.5):**

- a) For lightweight roofs and unenclosed Bda stone porch roofs, the rafters shall be connected to the wall plate or stringer using hurricane clips of the minimum allowable load capacity in accordance with Table 10.2.
- b) Where the rafters are attached to the main roof rafters they shall be bolted in accordance with Tables 10.4 or 10.5. The hurricane clip connection of the main rafters to the wall plate shall be increased to include the combined span of the main roof and the flat roof. (Combined load of Tables 10.1 and 10.2)
- c) Where the rafters in Table 10.3 are attached to masonry walls, they shall be connected by the use of timber stringers a minimum of 2"x6" in size. The stringers shall be connected to the walls in accordance with Tables 10.4 or 10.5. The bolts shall be set in the centre of the timber stringers at the spacing described and at 4" from each end of every section of timber. The bolts shall be cast a minimum of 4" into the opening of the block cell which shall be grouted with concrete. The rafters shall either bear on the stringers and be connected as per note a) above or they shall be side connected with joist hangers having a minimum allowable load as per Tables 10.2, 10.4 and 10.5.
- d) As an alternative to the anchor bolts cast into the masonry cells, *approved* expansion bolts may be used. These shall be fastened into masonry cells that have been concrete filled. They shall not be connected into hollow masonry cells.

**COLLAR TIE ROOF: COLLAR TIE AT ONE THIRD ROOF HEIGHT (H/3)**

Bermuda Slate Roof: Rafter spacing 16"

Span (feet)	Rafter Size and Collar Tie to Rafter Connection for Rafter of 16" & Roof Slope of:						Collar Tie Size	
	Roof Slope 5 in 12	Roof Slope 6 in 12	Roof Slope 7 in 12	Roof Slope 8 in 12	Roof Slope 9 in 12	Roof Slope 10 in 12	Without hangers	Hanger midspan
8	2x4 1x 1/2" bolt	2x4 1x 3/8" bolt	2x4 1x 3/8" bolt	2x4 1x 3/8" bolt	2x4 1x 3/8" bolt	2x4 1x 3/8" bolt	2x4	2x4
10	2x6 1x 1/2" bolt	2x6 1x 1/2" bolt	2x6 1x 3/8" bolt	2x6 1x 3/8" bolt	2x6 1x 3/8" bolt	2x6 1x 3/8" bolt	2x4	2x4
12	2x6 1x 5/8" bolt	2x6 1x 1/2" bolt	2x6 1x 1/2" bolt	2x6 1x 1/2" bolt	2x6 1x 3/8" bolt	2x6 1x 3/8" bolt	2x6	2x4
14	2x6 2x 3/8" bolts	2x6 1x 5/8" bolt	2x6 1x 5/8" bolt	2x6 1x 1/2" bolt	2x6 1x 1/2" bolt	2x8 1x 1/2" bolt	2x6	2x4
16	2x8 2x 1/2" bolts	2x8 2x 3/8" bolts	2x8 1x 5/8" bolt	2x8 1x 5/8" bolt	2x8 1x 1/2" bolt	2x8 1x 1/2" bolt	2x6	2x4
18	2x8 2x 1/2" bolts	2x8 2x 3/8" bolts	2x8 2x 3/8" bolts	2x8 1x 5/8" bolt	2x8 1x 5/8" bolt	2x10 1x 5/8" bolt	2x6	2x6
20	2x10 2x 5/8" bolts	2x10 2x 1/2" bolts	2x10 2x 3/8" bolts	2x10 2x 3/8" bolts	2x10 1x 5/8" bolt	2x10 1x 5/8" bolt	2x8	2x6
22	2x10 2x 5/8" bolts	2x10 2x 1/2" bolts	2x10 2x 1/2" bolts	2x10 2x 3/8" bolts	2x12 2x 3/8" bolts	2x12 2x 3/8" bolts	2x8	2x6

Table 10.6 – Collar tie at 1/3 roof height (Bermuda slate roof)

Lightweight Roof: Rafter spacing 24"

Span (feet)	Rafter Size and Collar Tie to Rafter Connection for Rafter of 24" & Roof Slope of:						Collar Tie Size	
	Roof Slope 5 in 12	Roof Slope 6 in 12	Roof Slope 7 in 12	Roof Slope 8 in 12	Roof Slope 9 in 12	Roof Slope 10 in 12	Without hangers	Hanger midspan
8	2x4 1x 3/8" bolt	2x4 1x 3/8" bolt	2x4 1x 3/8" bolt	2x4 1x 3/8" bolt	2x4 1x 3/8" bolt	2x4 1x 3/8" bolt	2x4	2x4
10	2x4 1x 3/8" bolt	2x4 1x 3/8" bolt	2x4 1x 3/8" bolt	2x4 1x 3/8" bolt	2x4 1x 3/8" bolt	2x4 1x 3/8" bolt	2x4	2x4
12	2x6 1x 1/2" bolt	2x6 1x 3/8" bolt	2x6 1x 3/8" bolt	2x6 1x 3/8" bolt	2x6 1x 3/8" bolt	2x6 1x 3/8" bolt	2x6	2x4
14	2x6 1x 1/2" bolt	2x6 1x 1/2" bolt	2x6 1x 3/8" bolt	2x6 1x 3/8" bolt	2x6 1x 3/8" bolt	2x6 1x 3/8" bolt	2x6	2x4
16	2x6 1x 5/8" bolt	2x6 1x 1/2" bolt	2x6 1x 1/2" bolt	2x6 1x 1/2" bolt	2x6 1x 3/8" bolt	2x8 1x 3/8" bolt	2x6	2x4
18	2x8 2x 3/8" bolts	2x8 1x 5/8" bolt	2x8 1x 1/2" bolt	2x8 1x 1/2" bolt	2x8 1x 1/2" bolt	2x8 1x 1/2" bolt	2x8	2x6
20	2x8 2x 3/8" bolts	2x8 1x 5/8" bolt	2x8 1x 5/8" bolt	2x8 1x 1/2" bolt	2x8 1x 1/2" bolt	2x8 1x 1/2" bolt	2x8	2x6
22	2x10 2x 1/2" bolts	2x10 2x 3/8" bolts	2x10 1x 5/8" bolts	2x10 1x 5/8" bolts	2x10 1x 1/2" bolt	2x10 1x 1/2" bolt	2x8	2x6
24	2x 1/2" bolts	2x10 2x 3/8" bolts	2x10 2x 3/8" bolts	2x10 1x 5/8" bolt	2x10 1x 5/8" bolt	2x10 1x 5/8" bolt	2x10	2x6

Table 10.7 - Collar tie at 1/3 roof height (Lightweight roof)

**NOTE:**

1. The span is defined as the horizontal distance between the centre of the supports.
2. The roof slope is expressed in terms of the vertical rise to horizontal run of the roof.
3. The top figure in each row is the minimum allowable rafter size in nominal inches.

4. The bottom figure in each row is the minimum allowable connection between the collar tie and the rafter.
5. It is acceptable to substitute 2x  $\frac{3}{8}$ " or 2x  $\frac{1}{2}$ " bolts in place of 1x  $\frac{5}{8}$  bolt or 1x  $\frac{3}{4}$ " bolt.
6. It is acceptable to substitute a 1  $\frac{1}{4}$ " diameter pitch pine or hardwood dowel in place of a  $\frac{3}{8}$ " or  $\frac{1}{2}$ " diameter bolt.
7. A support hanger to the collar tie at midspan is a vertical member attached to both the collar tie and the ridge plate above.
8. Bolt spacing and edge distances in accordance with section 15.9 must be complied with.

**COLLAR TIE ROOF: COLLAR TIE HEIGHT AT ONE HALF ROOF HEIGHT (H/2)****Bermuda Slate Roof: Rafter spacing 16"**

Span (feet)	Rafter Size and Collar Tie to Rafter Connection for Rafter of 16" & Roof Slope of:						Collar Tie Size	
	Roof Slope 5 in 12	Roof Slope 6 in 12	Roof Slope 7 in 12	Roof Slope 8 in 12	Roof Slope 9 in 12	Roof Slope 10 in 12	Without hangers	Hanger midspan
8	2x4 1x 5/8" bolt	2x4 1x 1/2" bolt	2x4 1x 1/2" bolt	2x4 1x 5/8" bolt	2x4 1x 3/8" bolt	2x4 1x 5/8" bolt	2x4	2x4
10	2x6 2x 3/8" bolts	2x6 1x 5/8" bolt	2x6 1x 1/2" bolt	2x6 1x 1/2" bolt	2x6 1x 1/2" bolt	2x6 1x 1/2" bolt	2x4	2x4
12	2x6 2x 1/2" bolt	2x6 2x 3/8" bolt	2x6 1x 5/8" bolt	2x6 1x 5/8" bolt	2x6 1x 1/2" bolt	2x6 1x 1/2" bolt	2x4	2x4
14	2x8 2x 1/2" bolts	2x8 2x 1/2" bolts	2x8 2x 3/8" bolt	2x8 1x 5/8" bolt	2x6 1x 5/8" bolt	2x8 1x 5/8" bolt	2x6	2x4
16	2x8 2x 5/8" bolts	2x8 2x 1/2" bolts	2x8 2x 1/2" bolts	2x8 2x 3/8" bolts	2x8 2x 3/8" bolts	2x10 2x 3/8" bolts	2x6	2x4
18	2x10 2x 5/8" bolts	2x10 2x 1/2" bolts	2x10 2x 1/2" bolts	2x10 2x 1/2" bolts	2x10 2x 3/8" bolts	2x10 2x 3/8" bolts	2x6	2x4
20	2x10 2x 3/4" bolts	2x12 2x 5/8" bolts	2x12 2x 1/2" bolts	2x12 2x 1/2" bolts	2x12 2x 1/2" bolts	2x12 2x 1/2" bolts	2x6	2x6
22	2x12 2x 3/4" bolts	2x12 2x 5/8" bolts	2x12 2x 5/8" bolts	2x12 2x 1/2" bolts	2x12 2x 1/2" bolts	N/A	2x8	2x6

Table 10.8 – Collar tie at 1/2 roof height (Bermuda slate roof)

**Lightweight Roof: Rafter spacing 24"**

Span (feet)	Rafter Size and Collar Tie to Rafter Connection for Rafter of 16" & Roof Slope of:						Collar Tie Size	
	Roof Slope 5 in 12	Roof Slope 6 in 12	Roof Slope 7 in 12	Roof Slope 8 in 12	Roof Slope 9 in 12	Roof Slope 10 in 12	Without hangers	Hanger midspan
8	2x4 1x 3/8" bolt	2x4 1x 3/8" bolt	2x4 1x 3/8" bolt	2x4 1x 3/8" bolt	2x4 1x 3/8" bolt	2x4 1x 3/8" bolt	2x4	2x4
10	2x6 1x 1/2" bolt	2x6 1x 1/2" bolt	2x6 1x 1/2" bolt	2x6 1x 3/8" bolt	2x6 1x 3/8" bolt	2x6 1x 3/8" bolt	2x4	2x4
12	2x6 1x 5/8" bolt	2x6 1x 1/2" bolt	2x6 1x 1/2" bolt	2x6 1x 1/2" bolt	2x6 1x 3/8" bolt	2x6 1x 3/8" bolt	2x4	2x4
14	2x6 2x 3/8" bolts	2x6 1x 5/8" bolt	2x6 1x 1/2" bolt	2x6 1x 1/2" bolt	2x6 1x 1/2" bolt	2x6 1x 1/2" bolt	2x6	2x4
16	2x8 2x 3/8" bolts	2x8 2x 3/8" bolts	2x8 1x 5/8" bolt	2x8 1x 5/8" bolt	2x8 1x 1/2" bolt	2x8 1x 1/2" bolt	2x6	2x4
18	2x8 2x 1/2" bolts	2x8 2x 3/8" bolts	2x8 2x 3/8" bolts	2x8 1x 5/8" bolt	2x8 1x 5/8" bolt	2x8 1x 1/2" bolt	2x6	2x4
20	2x10 2x 1/2" bolts	2x10 2x 1/2" bolts	2x10 2x 3/8" bolts	2x10 2x 3/8" bolts	2x10 1x 5/8" bolt	2x10 1x 5/8" bolt	2x6	2x6
22	2x10 2x 5/8" bolts	2x10 2x 1/2" bolts	2x10 2x 1/2" bolts	2x10 2x 3/8" bolts	2x12 2x 3/8" bolts	2x12 1x 5/8" bolt	2x8	2x6
24	2x12 2x 5/8" bolts	2x12 2x 1/2" bolts	2x12 2x 1/2" bolts	2x12 2x 1/2" bolts	2x12 2x 3/8" bolts	2x12 2x 3/8" bolts	2x8	2x6

Table 10.9 – Collar tie at 1/2 roof height (Lightweight roof)

**NOTE:**

1. The span is defined as the horizontal distance between the centre of the supports.

2. The roof slope is expressed in terms of the vertical rise to horizontal run of the roof.
3. The top figure in each row is the minimum allowable rafter size in nominal inches.
4. The bottom figure in each row is the minimum allowable connection between the collar tie and the rafter.
5. It is acceptable to substitute 2x  $\frac{3}{8}$ " or 2x  $\frac{1}{2}$ " bolts in place of 1x  $\frac{5}{8}$ " bolt or 1x  $\frac{3}{4}$ " bolt.
6. It is acceptable to substitute a 1  $\frac{1}{4}$ " diameter pitch pine or hardwood dowel in place of a  $\frac{3}{8}$ " or  $\frac{1}{2}$ " diameter bolt.
7. A support hanger to the collar tie at midspan is a vertical member attached to both the collar tie and the ridge plate above.
8. Bolt spacing and edge distances in accordance with section 15.9 must be complied with.

**COLLAR TIE ROOF: COLLAR TIE AT WALL PLATE LEVEL**

**Bermuda Slate Roof: Rafter spacing 16"**

Span (feet)	Rafter Size and Collar Tie to Rafter Connection for Rafter of 16" & Roof Slope of:						Collar Tie Size	
	Roof Slope 5 in 12	Roof Slope 6 in 12	Roof Slope 7 in 12	Roof Slope 8 in 12	Roof Slope 9 in 12	Roof Slope 10 in 12	Without hangers	Hanger midspan
8	2x4 1x <sup>3</sup> / <sub>8</sub> " bolt	2x4 1x <sup>3</sup> / <sub>8</sub> " bolt	2x4 1x <sup>3</sup> / <sub>8</sub> " bolt	2x4 1x <sup>3</sup> / <sub>8</sub> " bolt	2x4 1x <sup>3</sup> / <sub>8</sub> " bolt	2x4 1x <sup>3</sup> / <sub>8</sub> " bolt	2x4	2x4
10	2x6 1x <sup>3</sup> / <sub>8</sub> " bolt	2x6 1x <sup>3</sup> / <sub>8</sub> " bolt	2x6 1x <sup>3</sup> / <sub>8</sub> " bolt	2x6 1x <sup>3</sup> / <sub>8</sub> " bolt	2x6 1x <sup>3</sup> / <sub>8</sub> " bolt	2x6 1x <sup>3</sup> / <sub>8</sub> " bolt	2x6	2x4
12	2x6 1x <sup>1</sup> / <sub>2</sub> " bolt	2x6 1x <sup>3</sup> / <sub>8</sub> " bolt	2x6 1x <sup>3</sup> / <sub>8</sub> " bolt	2x6 1x <sup>3</sup> / <sub>8</sub> " bolt	2x6 1x <sup>3</sup> / <sub>8</sub> " bolt	2x6 1x <sup>3</sup> / <sub>8</sub> " bolt	2x6	2x4
14	2x6 1x <sup>1</sup> / <sub>2</sub> " bolts	2x6 1x <sup>1</sup> / <sub>2</sub> " bolts	2x6 1x <sup>3</sup> / <sub>8</sub> " bolt	2x6 1x <sup>3</sup> / <sub>8</sub> " bolt	2x6 1x <sup>3</sup> / <sub>8</sub> " bolt	2x6 1x <sup>3</sup> / <sub>8</sub> " bolt	2x8	2x4
16	2x6 1x <sup>5</sup> / <sub>8</sub> " bolts	2x6 1x <sup>1</sup> / <sub>2</sub> " bolts	2x6 1x <sup>1</sup> / <sub>2</sub> " bolts	2x6 1x <sup>3</sup> / <sub>8</sub> " bolt	2x6 1x <sup>3</sup> / <sub>8</sub> " bolt	2x6 1x <sup>3</sup> / <sub>8</sub> " bolt	2x8	2x6
18	2x8 1x <sup>5</sup> / <sub>8</sub> " bolt	2x8 1x <sup>1</sup> / <sub>2</sub> " bolt	2x8 1x <sup>1</sup> / <sub>2</sub> " bolt	2x8 1x <sup>1</sup> / <sub>2</sub> " bolt	2x8 1x <sup>3</sup> / <sub>8</sub> " bolt	2x8 1x <sup>3</sup> / <sub>8</sub> " bolt	N/A	2x6
20	2x8 2x <sup>3</sup> / <sub>8</sub> " bolts	2x8 1x <sup>5</sup> / <sub>8</sub> " bolt	2x8 1x <sup>1</sup> / <sub>2</sub> " bolt	2x8 1x <sup>1</sup> / <sub>2</sub> " bolt	2x8 1x <sup>1</sup> / <sub>2</sub> " bolt	2x8 1x <sup>1</sup> / <sub>2</sub> " bolt	N/A	2x6
22	2x10 2x <sup>3</sup> / <sub>8</sub> " bolts	2x10 1x <sup>5</sup> / <sub>8</sub> " bolt	2x10 1x <sup>5</sup> / <sub>8</sub> " bolt	2x10 1x <sup>1</sup> / <sub>2</sub> " bolt	2x10 1x <sup>1</sup> / <sub>2</sub> " bolt	2x10 1x <sup>1</sup> / <sub>2</sub> " bolt	N/A	2x6

Table 10.10 - Collar tie at wall plate (Bermuda slate roof)

**Lightweight Roof: Rafter spacing 24"**

Span (feet)	Rafter Size and Collar Tie to Rafter Connection for Rafter of 16" & Roof Slope of:						Collar Tie Size	
	Roof Slope 5 in 12	Roof Slope 6 in 12	Roof Slope 7 in 12	Roof Slope 8 in 12	Roof Slope 9 in 12	Roof Slope 10 in 12	Without hangers	Hanger midspan
8	2x4 1x <sup>3</sup> / <sub>8</sub> " bolt	2x4 1x <sup>3</sup> / <sub>8</sub> " bolt	2x4 1x <sup>3</sup> / <sub>8</sub> " bolt	2x4 1x <sup>3</sup> / <sub>8</sub> " bolt	2x4 1x <sup>3</sup> / <sub>8</sub> " bolt	2x4 1x <sup>3</sup> / <sub>8</sub> " bolt	2x6	2x4
10	2x4 1x <sup>3</sup> / <sub>8</sub> " bolt	2x4 1x <sup>3</sup> / <sub>8</sub> " bolt	2x4 1x <sup>3</sup> / <sub>8</sub> " bolt	2x4 1x <sup>3</sup> / <sub>8</sub> " bolt	2x4 1x <sup>3</sup> / <sub>8</sub> " bolt	2x4 1x <sup>3</sup> / <sub>8</sub> " bolt	2x6	2x4
12	2x6 1x <sup>3</sup> / <sub>8</sub> " bolt	2x6 1x <sup>3</sup> / <sub>8</sub> " bolt	2x6 1x <sup>3</sup> / <sub>8</sub> " bolt	2x6 1x <sup>3</sup> / <sub>8</sub> " bolt	2x6 1x <sup>3</sup> / <sub>8</sub> " bolt	2x6 1x <sup>3</sup> / <sub>8</sub> " bolt	2x6	2x4
14	2x6 1x <sup>3</sup> / <sub>8</sub> " bolt	2x6 1x <sup>3</sup> / <sub>8</sub> " bolt	2x6 1x <sup>3</sup> / <sub>8</sub> " bolt	2x6 1x <sup>3</sup> / <sub>8</sub> " bolt	2x6 1x <sup>3</sup> / <sub>8</sub> " bolt	2x6 1x <sup>3</sup> / <sub>8</sub> " bolt	2x8	2x4
16	2x6 1x <sup>3</sup> / <sub>8</sub> " bolt	2x6 1x <sup>3</sup> / <sub>8</sub> " bolt	2x6 1x <sup>3</sup> / <sub>8</sub> " bolt	2x6 1x <sup>3</sup> / <sub>8</sub> " bolt	2x6 1x <sup>3</sup> / <sub>8</sub> " bolt	2x6 1x <sup>3</sup> / <sub>8</sub> " bolt	N/A	2x6
18	2x6 1x <sup>1</sup> / <sub>2</sub> " bolt	2x6 1x <sup>3</sup> / <sub>8</sub> " bolt	2x6 1x <sup>3</sup> / <sub>8</sub> " bolt	2x6 1x <sup>3</sup> / <sub>8</sub> " bolt	2x6 1x <sup>3</sup> / <sub>8</sub> " bolt	2x6 1x <sup>3</sup> / <sub>8</sub> " bolt	N/A	2x6
20	2x8 1x <sup>1</sup> / <sub>2</sub> " bolt	2x8 1x <sup>1</sup> / <sub>2</sub> " bolt	2x8 1x <sup>3</sup> / <sub>8</sub> " bolt	2x8 1x <sup>3</sup> / <sub>8</sub> " bolt	2x8 1x <sup>3</sup> / <sub>8</sub> " bolt	2x8 1x <sup>3</sup> / <sub>8</sub> " bolt	N/A	2x6
22	2x8 1x <sup>5</sup> / <sub>8</sub> " bolt	2x8 1x <sup>1</sup> / <sub>2</sub> " bolt	2x8 1x <sup>1</sup> / <sub>2</sub> " bolt	2x8 1x <sup>3</sup> / <sub>8</sub> " bolt	2x8 1x <sup>3</sup> / <sub>8</sub> " bolt	2x8 1x <sup>3</sup> / <sub>8</sub> " bolt	N/A	2x6
24	2x10 1x <sup>5</sup> / <sub>8</sub> " bolt	2x10 1x <sup>1</sup> / <sub>2</sub> " bolt	2x10 1x <sup>1</sup> / <sub>2</sub> " bolt	2x10 1x <sup>1</sup> / <sub>2</sub> " bolt	2x10 1x <sup>1</sup> / <sub>2</sub> " bolt	2x10 1x <sup>3</sup> / <sub>8</sub> " bolt	N/A	2x8

Table 10.11 - Collar tie at wall plate (Lightweight roof)

**NOTE:**

1. The span is defined as the horizontal distance between the centre of the supports.
2. The roof slope is expressed in terms of the vertical rise to horizontal run of the roof.



3. The top figure in each row is the minimum allowable rafter size in nominal inches.
4. The bottom figure in each row is the minimum allowable connection between the collar tie and the rafter.
5. It is acceptable to substitute 2x $\frac{3}{8}$ " or 2x $\frac{1}{2}$ " bolts in place of 1x $\frac{5}{8}$ " bolt or 1x $\frac{3}{4}$ " bolt.
6. It is acceptable to substitute a 1  $\frac{1}{4}$ " diameter pitch pine or hardwood dowel in place of a  $\frac{3}{8}$ " or  $\frac{1}{2}$ " diameter bolt.
7. A support hanger to the collar tie at midspan is a vertical member attached to both the collar tie and the ridge plate above.
8. Bolt spacing and edge distances in accordance with section 15.9 must be complied with

#### **10.16 CHIMNEYS & FIREPLACES**

#### **10.17 FOUNDATIONS**

Masonry chimneys shall be supported on foundations of solid concrete at least 12" thick and extending at least 6" beyond each side of the exterior dimensions of the chimney. Footings shall be founded on material in accordance with sections 6.3 and 6.4. The foundations shall be reinforced with T12mm diameter bars at 12" c/c in both directions, placed 3" from the base of the footing.

#### **10.18 FIRE WALL CONSTRUCTION**

Fireplace walls shall be constructed of one of the following:

a) a minimum thickness of 8" masonry solid filled sand or grout;

or

b) a minimum of 8" thick Bermuda stone walls.

The walls shall be lined with a minimum of 4" of firebrick. A 1" wide gap shall be left between the firebrick and the fireplace walls and this shall be filled with sand. The liner shall extend a minimum of 4" into the throat of the fireplace. Joints in firebrick shall be a minimum of  $\frac{1}{2}$ ". Fires should not be started in the combustion chamber until 30 days after construction.

#### **10.19 FIREPLACES**

The firebox of a masonry fireplace shall have a minimum depth of 20". The throat shall not be less than 8" above the fireplace opening. The throat opening shall be not less than 4" in depth.

#### **10.20 HEARTH**

All fireplaces must have a hearth according to figure 11.2, unless the fire manufacturer's instructions specifically state otherwise. These fireplaces include masonry built ones as per Figures 11.1 and 11.2 that have a gas line installed at the time of its erection or if the owner builds a masonry fireplace solely for wood burning but later decides to install a gas line.

**Exceptions:**

1. Prefabricated gas fired devices that are fronted with glass doors where the manufacturer specifies that a hearth is not required;
2. Raised prefabricated gas fired devices where the manufacturer specifies that a hearth is not required; and
3. Prefabricated gas fired devices whereby the hearth is comprised of an approved non-combustible material specified by the manufacturer.

The hearth shall extend a minimum of 16" beyond the face of the fireplace, and a minimum of 8" on each side of the fireplace for fireplaces having an opening width of less than 6" sq.ft. The hearth of larger-sized fireplaces shall extend a minimum of 20" beyond the face and a minimum of 12" either side. The hearth shall be constructed of concrete, solid masonry or solid brick a minimum of 4" thick. Hearths can also be lined with approved non combustible material if desired.

**10.21 CLEARANCE TO COMBUSTIBLES**

The exterior surface of fireplace walls, the smoke chamber and chimneys shall have a minimum of 1 ½" air space clearance to combustibles. Any floors and roofs constructed of timber shall be properly trimmed in such a manner that no structural timbers bear on or in the walls of the fireplace or chimney. Combustible materials attached to the fireplace face such as trim shall have a minimum clearance of 6" from a fireplace opening. Combustible materials above and projecting more than 1 ½" from a fireplace face shall have a minimum clearance of 12" above a fireplace opening.

**10.22 STEEL FIREPLACE UNITS**

Steel fireplace units incorporating a firebox liner of not less than 1/4" in thickness and an air chamber may be installed with masonry to provide a total thickness at the back and sides of not less than 8" of hollow masonry units.

**10.23 LINTEL**

Masonry over a fireplace opening shall be supported by a lintel in accordance with section 9.7 or an approved steel lintel or brick arch.

**10.24 CHIMNEY SIZES**

The cross section of the area of the chimney flue should be not less than 1/10th of the area of the fireplace opening, but should not be less than 100 sq. inches.

**10.25 CHIMNEY WALLS**

Walls that are lined shall be constructed of minimum 8" unfilled masonry. Unlined chimney walls shall be constructed of a minimum of 8" solid filled masonry.

**10.26 CHIMNEY LINING**

Flue liners shall extend from the top of the smoke chamber to the top of the chimney. The liner shall consist of 1/2" cement rendering or 1/2" thick fireclay or other approved material.

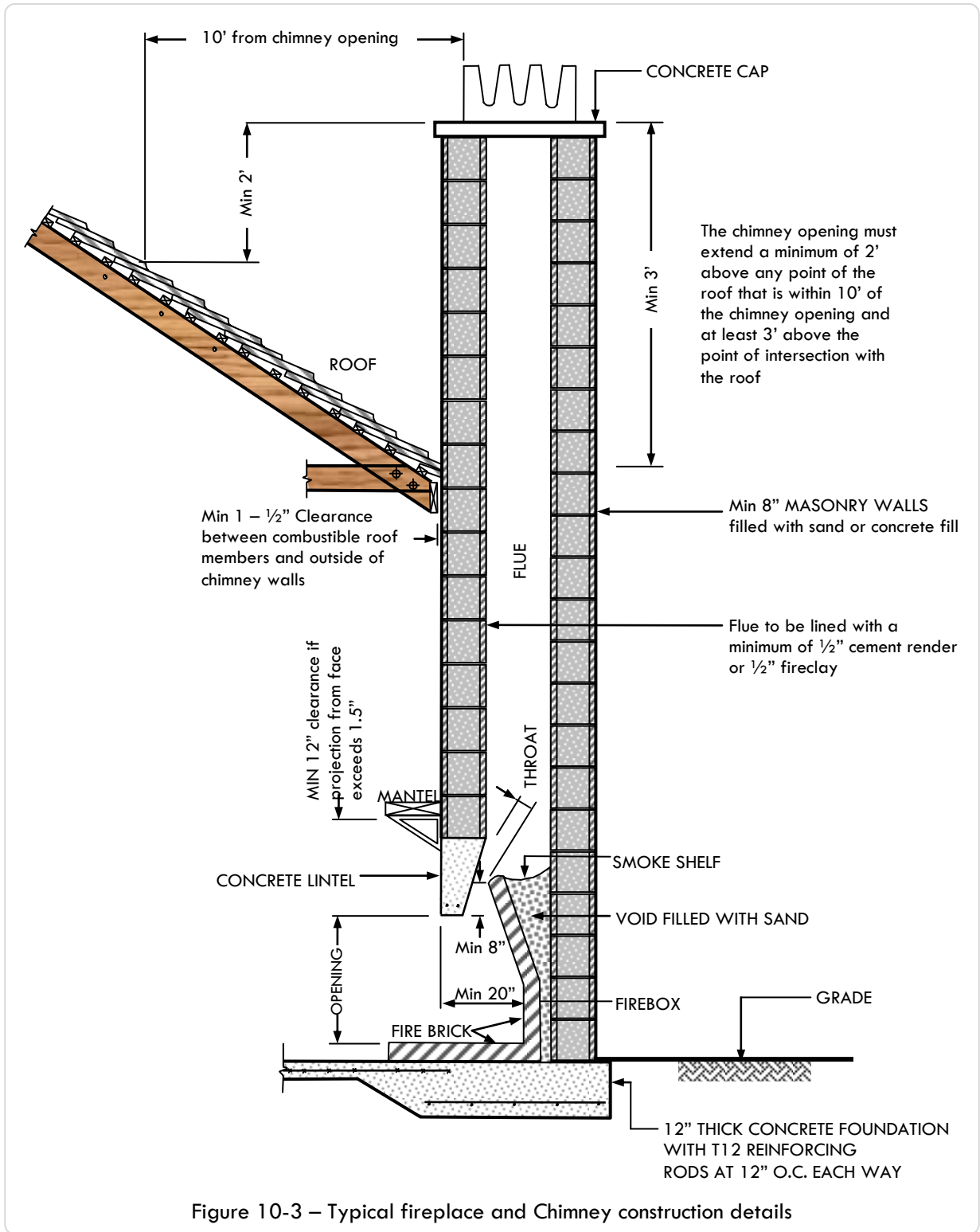
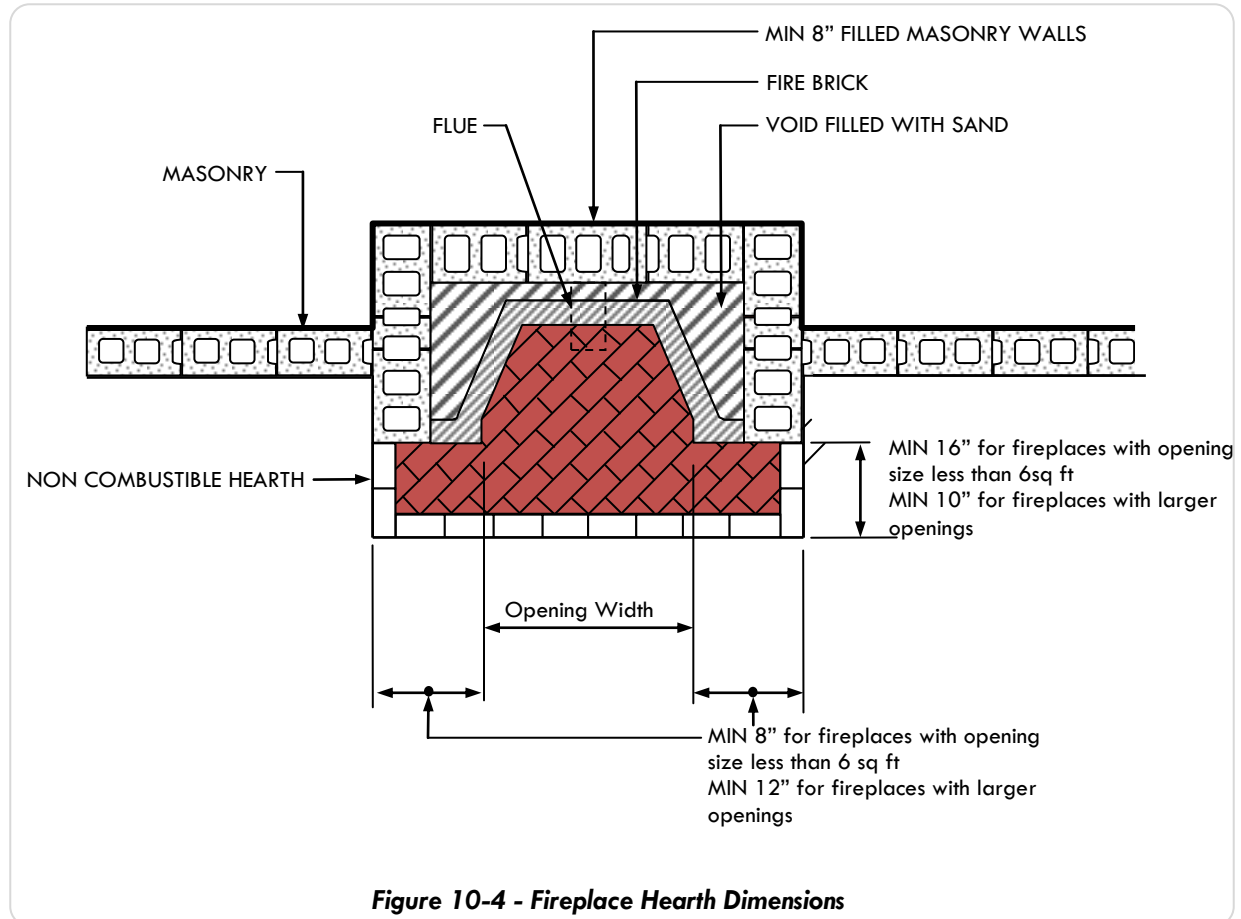

Figure 10-3 – Typical fireplace and Chimney construction details

### 10.27 CHIMNEY HEIGHT & LOCATION

The chimney shall extend a minimum of 3' above the highest point that the chimney penetrates the roof. They shall also be a minimum of 2' above any portion of the building that is within 10' of the chimney. Chimney openings shall be located not closer than 5' to the boundary line.



### 10.28 WEATHER PROOFING OF CHIMNEYS

The chimneys of every building shall adequately resist the penetration of rain into the building.

### 10.29 HEIGHT OF CHIMNEYS

The highest point of the chimney above the line of junction with the roof shall be not more than six times the minimum horizontal plan width of the chimney. If a higher chimney is required, the width of the chimney shall be increased accordingly.

### 10.30 FACTORY BUILT FIREPLACE UNITS

Factory built fireplaces that consist of a fire chamber assembly and a chimney may be installed if it is a listed assembly. Specifications of the proposed assembly must be submitted to the Building Official for approval prior to installation. The installation of such systems must be strictly in accordance with manufacturer's specifications.

**10.31 COMBUSTION AIR TO FURNACES**

The provision of combustion air must be considered for all fireplaces. The air tightness of the building and the use of other exhaust fans, kitchen ventilation systems and clothes drying appliances need to be taken into consideration in determining the adequacy of a space to provide combustion air. Factory built fireplaces shall have combustion air ducts installed in accordance with the manufacturer's instructions.

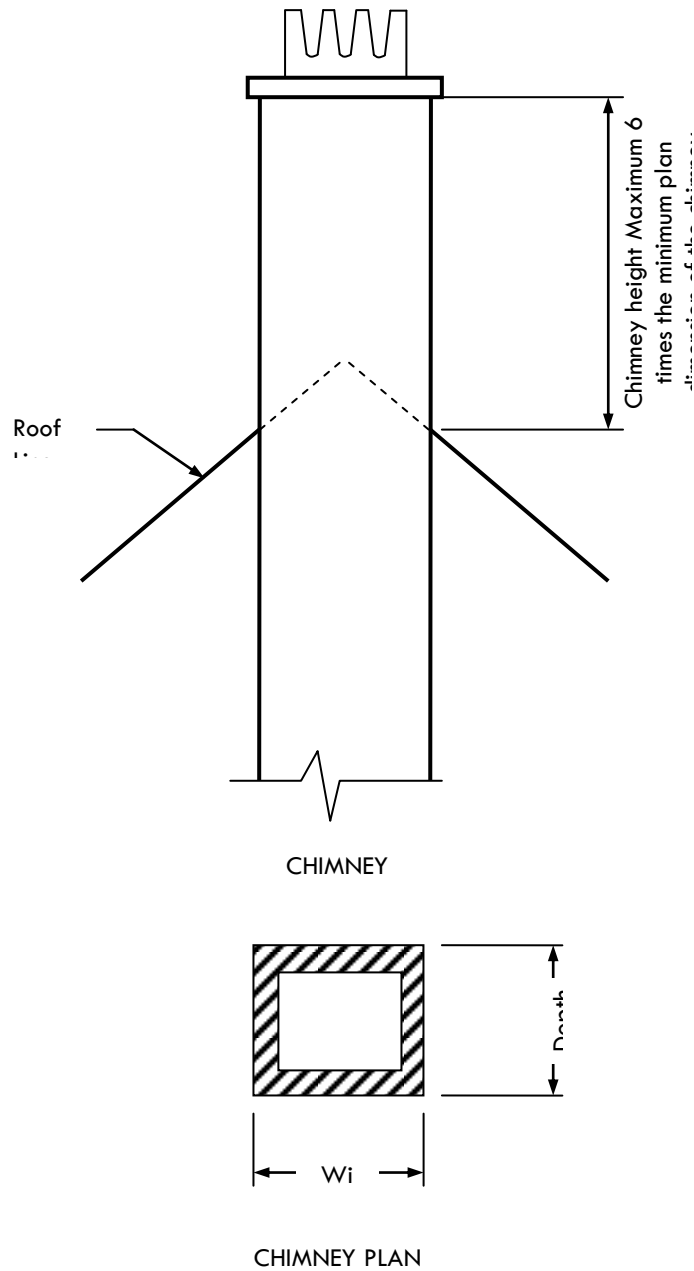

Figure 10-5 - Maximum Chimney Height



---

## **11 EXTERIOR WALLS**

---

### **11.1 GENERAL**

A material or wall covering shall be applied to the exterior side of the exterior walls for the purposes of providing a weather resistant barrier.

### **11.2 PLASTER**

For the purposes of achieving the above mentioned requirement the use of a ½" thick plaster coating on the exterior of the concrete masonry walls shall be required. The plaster shall be proportioned to 1 part cement: 4 parts sand: The plaster coating should be painted with a minimum of 2 coats of a compatible paint to further prevent moisture penetration.

### **11.3 ALTERNATIVE COATINGS**

The applicant shall apply to the Building Official for the right to use alternative types of weather proofing or energy efficient products.

### **11.4 WINDOWS AND DOORS**

All windows, door and other openings in exterior walls shall be adequately water tight to prevent the ingress of water into the building. All frames shall be adequately sealed to produce a water tight joint.





## 12 CONCRETE

### 12.1 GENERAL

Concrete shall comply with the provisions of this Chapter and where not referenced herein, in accordance with the provisions of the latest version of ACI-318.

### 12.2 CONCRETE QUALITY

#### 12.2.1 STRENGTH

The concrete shall be proportioned so as to achieve a minimum specified comprehensive strength of 2,500 PSI at 28 days (the average compressive strength of the mix shall be 3,500 PSI). [Note that the concrete strength is based on the testing of concrete. If concrete cubes are tested, the appropriate conversion factor will need to be applied].

Note: The guideline for a typical mix of ordinary 2,500 PSI concrete by volume is as follows:

**Typical Concrete Mix by Volume for 2500 psi strength**

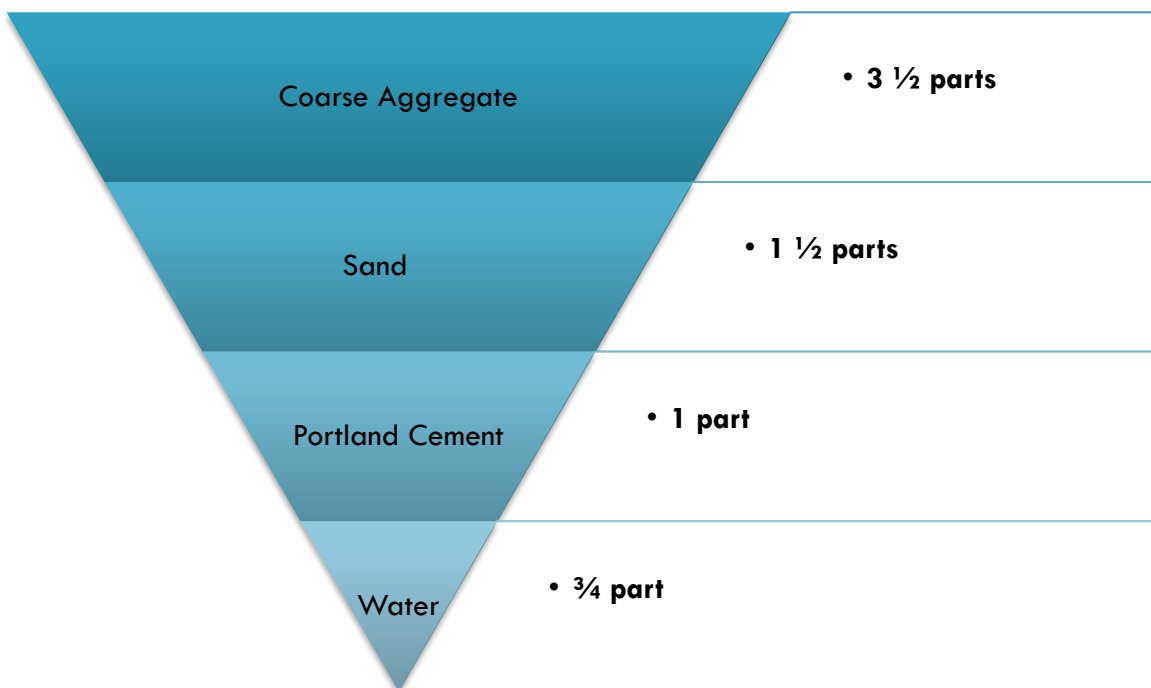

The part referred to could be a standard bucket or any other such measuring device so long as the same is used to measure all components of the mix. The water content will need to be adjusted based on the moisture content of the aggregate and sand being added to the mix. The wetter the aggregates, the less water will be needed. Water should be added to achieve a mix with approximately a 4" slump. Where the concrete is to be used in a severe exposure condition, such as in contact with sea water, the cement content should be increased and the water content decreased in order to increase durability. It is also good practice to select stronger imported aggregates, such as granite, in these instances.

**12.2.2 AGGREGATE**

The maximum aggregate size shall be  $\frac{3}{4}$ ". The aggregates shall be strong; hard; durable; of limited porosity; free of coating, clay, organic materials and other impurities; and chemically inert.

**12.2.3 SAND**

Fine aggregate shall be natural sand or sand derived from crushings, gravel or stone. It shall be clear, sharp, and free of lumps and of clay and other foreign material. (Note: beach sand shall not be used).

**12.2.4 WATER**

Water shall be clean, fresh, potable and free of organic material. Sea water or well water (unless potable) shall not be used.

**12.2.5 CEMENT**

Ordinary Portland cement shall be used unless approval in writing by the *Building Official* for an alternative is obtained prior to construction commencing.

**12.2.6 WATER/CEMENT RATIO**

The water cement ratio shall not exceed 0.67 by weight for 2,500 PSI concrete (i.e. 7.6 US gallons per 94lb bag of cement).

**12.2.7 REINFORCING**

Reinforcing bars shall be deformed (except for mesh reinforcing), galvanized to Class II standard ASTM A767, and of minimum yield strength of 60 ksi (414 N/mm<sup>2</sup>). They shall be free from pitting, rust, mill scale, paint, oil, grease, dirt, or any other material.

**12.2.7.1 FIBRE REINFORCED CONCRETE**

The use of fibre reinforced concrete in lieu of reinforced concrete shall not be permitted unless the prior express approval of the *Building Official* has been obtained.

**12.3 PREPARATION OF EQUIPMENT & PLACE OF DEPOSIT****12.3.1 EQUIPMENT**

All equipment for mixing and transporting cement shall be clean.

**12.3.2 CLEANING**

Immediately prior to placing concrete, the area shall be thoroughly cleaned out.

**12.3.3 WETTING FORMS**

All forms shall be wet down prior to placing the concrete.

**12.3.4 REINFORCEMENT**

Reinforcement shall be clean and adequately supported.

**12.3.5 EXCESS WATER**

Water shall be removed from the place of deposit before concrete is placed.

**12.3.6 LAITANCE**

All laitance and other unsound material shall be removed before additional concrete is placed against hardened concrete.

**12.4 MIXING**

All concrete shall be mixed until there is a uniform distribution of materials. Mixing shall be continued for at least 1½ minutes after all materials are in the drum. All materials shall be discharged completely before the mixer is refilled.

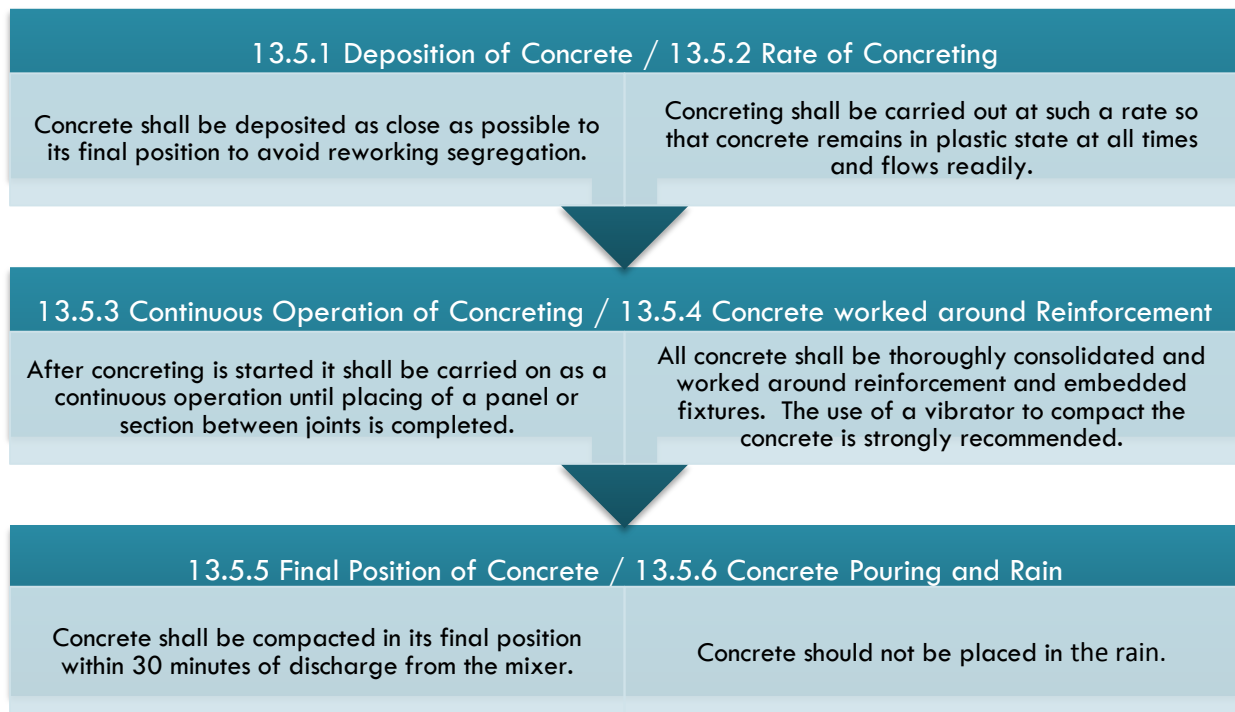
**12.5 PLACING CONCRETE****12.6 CONSTRUCTION JOINTS****12.6.1 CONSTRUCTION JOINTS**

Construction joints shall be square and vertical in beams and slabs or horizontal in columns and walls as required. The joints shall pass entirely through the depth of the member.

**12.6.2 LOCATION OF JOINTS**

Beams and lintels shall be placed without the provision of a joint. Joints in slabs shall be vertical and parallel to the principle reinforcement.

**12.6.3 NEW CONCRETE**

Where new concrete is to be poured against construction joints, the surfaces shall be cleaned and all laitance removed prior to placement.

**12.7 FORMWORK**

All formwork shall conform to the following:

1. Formwork shall be fixed in its correct position and securely braced to withstand, without displacement, the loading from the construction and the movement of persons, material and equipment, including the effects of vibrating the concrete.
2. Forms shall be sufficiently tight to prevent leakage of the concrete or water.
3. Where foundations are placed in sound hard rock, the *Building Official* may allow the contractor to place the concrete up against the rock without the use of forms.
4. The formwork and supports shall not be removed for a minimum of 21 days for structural suspended concrete until the concrete has reached sufficient strength to support the applied loads.
5. Any screed chairs that are used in the placing of concrete and remain in the concrete shall be galvanized. The minimum cover to these chairs shall be in accordance with Table 13.1.

**12.8 Curing:** The concrete shall be adequately cured after placement by either:

a) Water spraying or ponding,

b) Wet coverings of hessian or sand,

c) Covering with waterproof paper or polythene sheet, or

d) Use of an *approved proprietary curing agent*.

## **12.8 PLACEMENT OF REINFORCING**

### **12.8.1 BENDING**

After reinforcing is bent or cut, the area concerned should be painted with at least 1 coat of zinc rich paint. Bars shall not be re-bent.

### **12.8.2 FIXING**

Reinforcing shall be accurately fixed and maintained in position. Plastic chairs may be used as long as they satisfactorily support the reinforcing during concrete placement. Concrete or masonry cover blocks shall be not larger than 2"x2" in plan dimensions. Metal chairs shall be galvanized. The use of timber or stone shall not be allowed.

### **12.8.3 TIE WIRE**

Tie wire shall be galvanized.

### **12.8.4 MINIMUM SPACING**

The minimum clear spacing between parallel reinforcing bars shall be 1".

### **12.8.5 COVER**

The minimum concrete cover to the outside of reinforcing shall be in accordance with Table 13.1.

Minimum Cover to Reinforcing Bars	
Structural Element and Condition	Minimum Cover (inches)
Cast against and permanently exposed to the earth	3"
Concrete exposed to the weather	1 ½"
Concrete not exposed to the weather; slabs & walls	1"
Concrete not exposed to the weather; beams & columns	½"

Table 12.1 - Minimum Cover to Reinforcing Bars

**12.8.6 LAPS & JOINTS**

Wire mesh reinforcing shall be lapped a minimum of one square. Reinforcing bars shall be lapped a minimum distance in accordance with Table 13.2. These values shall not apply to cantilever slabs where the conditions of section 8.4.8 shall apply. Bars shall not be lapped in the middle third of the span of beams and suspended slabs.

Minimum Allowable Lap Lengths	
Bar Size	Minimum Cover (inches)
T10	18"
T12	24"
T16	30"
T20	36"
T25	60"

Table 12.2 - Minimum Allowable Lap Lengths for Reinforced Concrete

**12.8.7 ALTERNATIVE BAR SIZES**

The bar sizes shown throughout the code refer to the diameter in millimeters of the bar. Alternatively, imperial bar sizes can be substituted in accordance with Table 13.3.

Alternative Bar Sizes		
Metric Bar Size (mm)	Imperial Equivalent (inches)	Former Imperial Designation
T10	⅜"	#3
T12	½"	#4
T16	⅝"	#5
T20	¾"	#6
T25	1"	#8

Table 12.3 – Alternative bar sizes

**12.8.8 ALTERNATIVE MESH SIZES**

The mesh sizes referred throughout the code refer to the cross sectional area in millimeters per meter width of the mesh. Alternatively, imperial mesh sizes can be substituted if their areas of steel are equal to or greater than the specified metric meshes. A list of standard mesh sizes and their cross sectional steel areas are provided in Table 13.4.

Alternative Mesh Sizes		
Imperial Mesh (by spacing in inches and wire gauge)	New Designation (by spacing and cross sectional area of individual bars in hundredth of a square inch)	Reinforcement area of imperial bars in mm <sup>2</sup> /m
6 x 6 - 10g x 10g	6 x 6 - W 1.4 x W 1.4	59
6 x 6 - 8g x 8g	6 x 6 - W 2.0 x W 2.0	85
6 x 6 - 6g x 6g	6 x 6 - W 2.9 x W 2.9	122
6 x 6 - 4g x 4g	6 x 6 - W 4.0 x W 4.0	169
4 x 4 - 10g x 10g	4 x 4 - W 1.4 x W 1.4	89
4 x 4 - 8g x 8g	4 x 4 - W 2.0 x W 2.0	127
4 x 4 - 6g x 6g	4 x 4 - W 2.9 x W 2.9	184
4 x 4 - 4g x 4g	4 x 4 - W 4.0 x W 4.0	254

**Table 12.4 - Alternative Mesh Sizes**

## 13 MASONRY CONSTRUCTION

### 13.1 GENERAL

Masonry shall comply with the provisions of this Chapter and where not referenced herein, in accordance with the provisions of the latest version of ACI 530 and 530.1. Any conditions not specifically covered by this chapter shall be designed, inspected and approved by a registered engineer prior to inspection by the Building Official.

### 13.2 MASONRY UNITS

Masonry units shall conform to the latest version of ASTM C90 (The minimum average compressive strength of 3 units shall be 1,900 psi based on the net area on the units. The test shall be in accordance with ASTM C140). The unit shall be of whole, sound material, and free of cracks and other defects that would interfere with its proper laying or use, and shall be free of old mortar if being reused.

### 13.3 NATURAL STONE

Natural stone shall be sound and free from loose or friable inclusions.

### 13.4 MORTAR

Mortar shall conform to the latest version of ASTM C-270, and shall be of grade S or greater. This shall result in a mortar mix by volume in accordance with Table 14.1.

Required Mixes for Building Mortar			
Building Element	Portland Cement	Lime*	Sand
External Walls and Loadbearing walls	1	½	4
Internal Partition Walls	1	1	6
Retaining Walls	1	½	3
Roof Slate	1	-	8

Table 13.1 - Required Mixes for Building Mortar

\*Note: Lime may be substituted with an approved mortar plasticiser.

### 13.5 PLASTER

Walls shall be rendered with mortar mixes in accordance with Table 14.2. All interior walls to habitable and ancillary rooms and all exterior walls shall receive a minimum of ½" of plaster or other finish as may be approved by the *Building Official*.

Required Mixes for Plastering Mortar			
Building Element	Portland Cement	Lime*	Sand
Plaster to external walls	1	½	4
Plaster to internal walls	1	½	5
Plaster to foundation walls	1	-	2
Plaster to Water Tanks	1	-	2

Table 13.2 - Required Mixes for Plastering Mortar

**\*Note:** Lime may be substituted with an approved mortar plasticiser.

### 13.6 LAYING BLOCKS

All blockwork shall be laid in running bond. The head and bed joints shall be ⅜" thick with a maximum tolerance of 1/8". The bed joint of the starting course placed on the foundation or slab shall be not less than ¼" or greater than ¾". Blocks shall be clean and wetted prior to laying mortar.

#### 13.6.1 **HOLLOW BLOCKS**

All head and bed joints shall be filled solidly with mortar for a distance in from the face of the unit not less than the thickness of the face shell.

#### 13.6.2 **SOLID BLOCKS AND NATURAL STONE**

All solid units shall be laid with full head and bed joints.

#### 13.6.3 **NUMBER OF COURSES**

Walls shall be carried up simultaneously and in no case shall a wall or section of wall be built more than 6 courses ahead of an adjoining wall.

### 13.7 CONCRETE FILLED MASONRY

#### 13.7.1 **CONCRETE FILL**

The concrete fill for masonry walls shall be of minimum specified 28 day compressive strength of 1500 PSI. The slump of the concrete fill shall be 4 to 6". The mix proportions by volume shall be as follows:

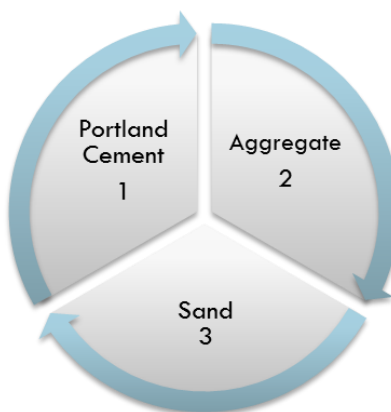



**13.7.2 CONCRETE FILL PLACEMENT**

All cells that are required to be concrete filled shall be properly cleaned out to ensure that the concrete can adequately flow into the opening. Mortar projections greater than ½" into the grout space shall be removed. Concrete fill shall be placed in maximum lifts of 4' and shall be raised to 2" below the top of the highest block. Concrete fill shall be adequately consolidated after placement. All concrete fill shall be in place within 1 ½ hours after water is added to the cement.

**13.8 REINFORCED MASONRY****13.8.1 REINFORCING**

Reinforcing bars shall be deformed (except for mesh reinforcing), shall be galvanized to Class II standard ASTM A767 and shall be of minimum yield strength of 60 ksi (414 N/mm<sup>2</sup>). They shall be free from pitting, rust, mill scale, oil, grease, dirt, or any other material.

**13.8.2 LAP LENGTH**

The minimum lap length of reinforcing bars shall be in accordance with Table 14.3.

Minimum Allowable Lap Lengths	
Bar Size	Maximum Tie Spacing (inches)
T10	20"
T12	24"
T16	32"
T20	40"
T25	48"

Table 13.3 - Minimum Allowable Lap Lengths for Reinforced Masonry

**13.8.3 TIES**

Bars shall be securely fixed in position at top and bottom and at intervals not exceeding 200 bar diameters.

**13.8.4 CELLS TO BE CONCRETE FILLED**

All cells containing reinforcing shall be filled solidly with concrete fill.

**13.8.5 ALTERNATIVE BAR SIZES**

The bar sizes shown throughout the code refer to the diameter in millimeters of the bar.

Alternative imperial bar sizes can be used in accordance with Table 14.4.

Alternative Bar Sizes		
Metric Bar Size (mm)	Imperial Equivalent (inches)	Former Imperial Designation
T10	3/8"	#3
T12	1/2"	#4
T16	5/8"	#5
T20	3/4"	#6
T25	1"	#8

Table 13.4 - Alternative Bar Sizes



## 14 TIMBER

### 14.1 TIMBER PROPERTIES

Framing lumber shall be of No. 2 (or similar grade) Common Grade Long Leaf Yellow Pine or Short Leaf Pine, and shall be graded in conformance with the American Softwood Lumber Standard PS-20. The minimum lumber sizes shall be standard dressed sizes in accordance with Table 15.1. The minimum modulus of elasticity (E) for the timber shall be 1,600,000 psi.

Minimum Timber Properties of Standard Dressed Lumber		
Nominal Size (inches)	Standard Dressed Size (inches)	Minimum Bending Stress (psi)
2 x 4	1 ½ x 3 ½	1500
2 x 6	1 ½ x 5 ½	1250
2 x 8	1 ½ x 7 ¼	1200
2 x 10	1 ½ x 9 ¼	1050
2 x 12	1 ½ x 11 ¼	975

Table 14.1 - Minimum Timber Properties of Standard Dressed Lumber

### 14.2 TREATMENT

All exterior structural framing lumber in wet locations shall be pressure treated with preservative by the wolmanised process to the following standard: 0.25 lb/ft<sup>3</sup> Chromated Copper Arsenate (CCA) (this is also recommended for timber in damp locations). Wet locations shall include decks and patios and any members directly exposed to the weather. Damp locations shall include roofed open sided porches, subfloor areas, and basements where a wall or the floor are of exposed ground. Exterior below grade timbers and other members in contact with the ground, such as posts, shall be treated to a minimum standard of: 0.4 lb/ft<sup>3</sup> CCA.

### 14.3 MOISTURE CONTENT

The timber shall be kiln dried to a maximum moisture content of 19%.

### 14.4 IDENTIFICATION

All lumber used for load supporting purposes shall be identified by the grade mark of an approved lumber grading or an approved inspection agency. In lieu of a grade mark, a certificate of inspection as to the species and grade issued by an approved lumber grading or an approved inspection agency may be accepted.

### 14.5 CONNECTIONS

All nails, bolts, screws, clips, anchors, and hurricane ties used in timber connections shall be galvanised or made with some other type of non corrosive material such as brass or stainless steel.

**14.6 NOTCHES**

Notches in timber members shall not exceed 1/5th of the depth of the member, or be greater in length than 1/3 of the depth of the member, and shall not be located in the middle third of the span. The minimum spacing between notches shall be not less than the depth of the member.

**14.7 HOLES**

Holes drilled in timber members shall be within the middle third of the depth of the member and shall be located no closer than 2 inches from an edge. Holes shall be not more than 1/5th of the depth or 2" in diameter, whichever is smaller, and the minimum spacing between the edges of the holes shall be not less than the depth of the member.

**14.8 SUPPORTS**

Timber members shall have a minimum bearing on timber supports of 1½" and shall not bear directly onto masonry or Bermuda stone. A bond timber shall be placed on top of the masonry or stone and the timber members shall bear on these. The bond timbers (except those of Bermuda cedar) shall be pressure treated with preservative by the wolmanised process to the following standard: 0.25 lb/ft<sup>3</sup> CCA. The ends of the timber joists or rafters shall be treated with an approved wood sealer to prevent dampness entering the timber. Alternatively, timber joists and rafters may be connected to stringers by the use of approved joist hangers. Specification sheets of the intended joist hanger must be supplied.

**14.9 PLACEMENT OF BOLTS**

All bolts for timber shall be placed in accordance with Table 15.2.

Diameter of Bolt	Spacing	Bolt to Loaded Edge	Bolt to Unloaded Edge	Bolt to Loaded End	Bolt to Unloaded End
3/8"	1 1/2"	1 1/2"	3/4"	2 1/2"	1 1/2"
1/2"	2"	2"	1"	3 1/2"	2"
5/8"	2 1/2"	2 1/2"	1 1/4"	4 1/2"	2 1/2"
3/4"	3"	3"	1 1/2"	5"	3"

Table 14.2 - Allowable Placement Distances of Bolts in Timber

**Notes:**

- Spacing:** Refers to the distance between the centres of bolts.
- Edge Distance:** The distance from the edge of a timber member to the centre of the nearest bolt, measured perpendicular to the grain.
- End Distance:** The distance measured parallel to the grain from the square cut end of a member to the centre of the nearest bolt.
- Loaded Edge:** When a timber member is loaded perpendicular to the grain, the loaded edge is defined as the edge in the direction towards which the bolt is acting.
- Unloaded Edge:** When a timber member is loaded perpendicular to the grain, the unloaded edge is defined as the edge of the timber opposite the direction in which the load is acting.

6. **Loaded End:** When a timber member is loaded parallel to the grain, the loaded end is defined as the direction towards which the bolt is acting.
7. **Unloaded End:** When a timber member is loaded parallel to the grain, the unloaded end is defined as the end opposite the direction in which the bolt is acting.

#### **14.10 TIMBER COLUMNS**

Timber columns shall be not less than 4"x4" in size or less than the width of the timber member that they support, whichever is greater, unless calculations are provided to show that smaller sizes are adequate. All columns shall be adequately anchored to prevent uplift due to wind.

#### **14.11 STORAGE AND HANDLING**

All timber shall be stored on the site elevated above the ground and in a position to allow the circulation of air around the timber. Timber should be covered during storage and covers shall be adequately ventilated to prevent condensation.



---

## **15 STEEL**

---

### **15.1 GENERAL**

Any conditions not specifically covered by this chapter shall be designed, inspected and approved by a registered engineer prior to inspection by the *Building Official*.

### **15.2 STRUCTURAL STEEL**

#### **15.2.1 GRADE OF STEEL**

Where structural steel is specified, the grade of the steel shall be clearly indicated on the drawings.

#### **15.2.2 PROTECTIVE COATING**

All structural steel shall be delivered to the site with at least 1 coat of suitable priming system. Damaged areas shall be touched up on site.

#### **15.2.3 STORAGE & HANDLING**

Structural steel shall be stored and handled at the site so as to prevent damage. It shall not be laid directly on the ground. Suitable packing shall be placed between layers of stacked steelwork. Where cover is provided, it shall be adequately ventilated to prevent condensation.

#### **15.2.4 ERECTION**

Steel members shall be installed in accordance with the drawings provided.

#### **15.2.5 STRUCTURAL MEMBER SIZES**

Steel members shall be sized and specified by a registered structural engineer.

### **15.3 CONNECTIONS**

#### **15.3.1 PROTECTIVE COATING**

All nuts, bolts, washers, nails, screws and other fasteners should be hot dip galvanized in accordance with ASTM A153. All joist hangers, hurricane clips and other connectors shall be hot dip galvanized in accordance with ASTM A525 to a minimum standard of G60.

#### **15.3.2 ANCHOR BOLTS**

Anchor bolts shall be set in the correct locations using templates. They shall not be bent after concreting to force them to fit.

#### **15.3.3 BOLTED CONNECTIONS**

After tightening the connections, at least 2 threads of the bolt shall project beyond the edge of the nut.

#### **15.3.4 FIELD WELDING**

Any intended field welding shall be clearly identified on the plans submitted for approval and will be required to be specified by a registered engineer. All such welds shall be inspected upon completion by the aforementioned design engineer or a locally registered engineer and a written certificate of compliance shall be submitted to the Building Official by the engineer.

**15.3.5 HOLES IN MEMBERS**

Any holes or openings in structural members aside from those specified on the drawings submitted for approval shall be prohibited.



---

**16 GLAZING**

---

**16.1 LABELING**

Each piece of safety glazing shall bear the manufacturer's label designating the type and thickness of glass.

**16.2 DESIGN**

All glazing shall be designed to meet the applicable wind loads for a 150 mph basic 3 second gust wind speed, exposure category C or D.

**16.3 SAFETY GLAZING**

All glass in the following locations shall be constructed of impact resistant safety glazing in accordance with the Bermuda Commercial Building Code:

- a) glazing in swinging doors where the panel size exceeds 3 square feet in area;
- b) all glazing in fixed and sliding panels of sliding door assemblies;
- c) all glazing in doors and enclosures for bathtubs, showers, hot tubs, whirlpools, saunas, steam rooms, indoor pools and outdoor pools;
- d) glazing in any part of the building wall enclosing the compartments listed in item © where the bottom edge of the glazing is less than 60" above the drain inlet;
- e) glazing where the bottom edge of the pane is less than 18" above the floor surface and the panel size exceeds 3 feet; and,
- f) all glazing in guardrail assemblies.



---

## **17 SWIMMING POOLS, SPAS AND HOT TUBS**

---

### **17.1 LOCATIONS**

Swimming pool locations shall conform to the requirements of the current development plan. The pool shall also be located such that it does not undermine any existing foundation. This will be deemed to be achieved if the pool is placed a horizontal distance from the outside of the existing foundation equal to or greater than the depth of the pool wall.

If a pool location is less than the distance measured horizontally from the outside of the existing foundation in regards to depth then a local registered engineer is to be consulted.

### **17.2 STRUCTURAL DESIGN**

The pool structure shall be engineered to withstand the expected forces to which the pool will be subjected.

A pool can be built either above or in the ground, and from materials such as concrete (also known as gunite), metal, plastic, or fiberglass. There are several distinct construction methods for private (home) swimming pools, which are typically called "concrete", "vinyl liner", and "fiberglass". The term "vinyl liner" pool describes the method of lining the interior, not the construction materials, which may be concrete (of various types), pressure-treated wood, or paint-coated or galvanized sheet steel.

### **17.3 WALL SLOPES**

To a depth of 2'-9" from the top of the pool, the wall slope shall not exceed one unit horizontal to five unit's vertical (5:1). No projections beyond the walls of the pool other than the egress steps shall be permitted.

### **17.4 FLOOR SLOPES**

The slope of the floor on the shallow side of the transition point shall not exceed one unit vertical to seven units horizontal (1:7). The transition point between shallow and deep water shall not be more than 5 feet deep.

### **17.5 STEPS AND LADDERS**

At least one means of egress shall be provided. Treads of steps and ladders shall have slip resistant surfaces. Step treads shall have a minimum dimension of 10" and a minimum surface area of 240 sq. inches. Risers shall have a maximum height of 12". The bottom risers shall not vary by more than 2" from the remainder. Handrails shall be installed on both sides of ladders and one side of steps. For pools with a deep end and a shallow end, two means of egress should be provided, one at either end of the pool.

### **17.6 WATER SUPPLY**

All swimming pools shall be provided with a water supply that is entirely free of cross connections with the household potable water system.

## **17.7**      **WATER TREATMENT**

Swimming pools shall be designed and installed such that there is a pool water turnover at least once every 8 hours. Spas and hot tubs shall be provided with a filter system that provides for a water turnover of once every ½ an hour. Treatment systems shall be installed so that they are not accessible to children.

## **17.8**      **DRAINAGE SYSTEMS**

The swimming pool and equipment shall be equipped to be emptied completely of water. Discharge shall be into a backwash pit of minimum size 4'x4'x4' deep or other such *approved* size as the Building Official deems necessary. The backwash pit shall be located on the owner's property not closer than 5' to any boundary. Alternatively, discharge may be by way of a borehole approved by the Environmental Authority.

### **17.8.1**      **ANTI-ENTRAPMENT GRATES**

Pool drainage outlets less than 12 inches across shall be covered with anti-entrapment grates that cannot be removed except with the use of tools. Slots or openings in the grates or similar protective devices shall not exceed ½ inch in the smallest dimension and shall be of a shape and arrangement that would not prevent physical entrapment and would not pose any such hazard to bathers. Anti-entrapment covers are required for new pools and spas, structural remodeling of an existing pool or spa, and for an existing pool or spa on a property whenever a building permit is issued under this code for that property.

### **17.8.2**      **PRIVATE POOLS**

Each new pool or spa shall have a minimum of two circulation drains per pump. The drains or outlets shall be hydraulically balanced and symmetrically plumbed through one or more "T" fittings and separated by a distance of at least five feet in any dimension between drains.

## **17.9**      **EQUIPMENT INSTALLATION**

Pumps, filters and other mechanical and electrical equipment shall be enclosed in their own separate room. The equipment shall be suitable for the location. Any electrical panel boards shall be installed in accordance with section 21.18. Where the panel board is installed in the same room as the swimming pool equipment, it shall be listed for this location.

## **17.10**      **BARRIER/ENCLOSURE REQUIREMENTS**

### **17.10.1**      **APPLICATION**

The provisions of this section shall control the design for residential swimming pools, spas and hot tubs or any other pool of water capable of holding a 24" depth of water or greater. These provisions are intended to provide protection against potential drowning.

## 17.10.2 OUTDOOR PRIVATE SWIMMING POOL

### 17.10.2.1 TEMPORARY BARRIERS

During the installation or construction of a swimming pool, the pool must be ENTIRELY enclosed by a temporary barrier. The temporary barrier may be a temporary fence, a permanent fence, the wall of a permanent structure, or any other structure or combination of those. However, the temporary barrier must:

1. be at least four (4) feet high;
2. prevent access to the swimming pool by any person not installing or constructing the pool;
3. remain in place until a permanent pool barrier is provided ; and
4. be replaced by a permanent pool barrier within either:
  - 90 days of the date of issuance of the building permit for the installation or construction of the swimming pool; or
  - 90 days of the date of commencement of the installation or construction of the swimming pool.

The code enforcement official may extend the time period to complete the permanent barrier for good cause, including but not limited to adverse weather conditions delaying construction.

There are some **exceptions** to the requirement for temporary pool barriers:

1. Above-ground or on-ground pools where the pool structure itself serves as the barrier
2. Spas or hot tubs with a safety cover, as long as the safety cover remains in place during the installation or construction.
  - The safety cover can be removed temporarily for the installation or construction of the hot tub or spa if at least one person engaged in the installation or construction is present.

### 17.10.2.2 PERMANENT BARRIERS

An outdoor private swimming pool, including an in-ground, above-ground or on-ground pool, hot tub or spa shall be provided with a barrier which complies with the provisions set out below:

1. The top of the barrier shall be at least 48 inches above finished ground level measured on the side of the barrier which faces away from the swimming pool. The maximum vertical clearance between finished ground level and the barrier shall be 4 inches measured on the side of the barrier which faces away from the swimming pool. Where the top of the pool structure is above finished ground level, such as an above ground pool, the barrier shall be at finished ground level, such as the pool structure, or shall be mounted on top of the pool structure. Where the barrier is mounted on the pool structure, the opening between the top surface of the pool frame and the bottom of the barrier shall not allow passage of a 4-inch diameter sphere.

2. Openings in the barrier shall not allow passage of a 4-inch diameter sphere.
3. Solid barriers shall not contain indentations or protrusions except for normal construction tolerances and tooled masonry joints.
4. Where the barrier is composed of horizontal and vertical members and the distance between the tops of the horizontal members is less than 45 inches, the horizontal members shall be located on the swimming pool side of the fence. Spacing between the vertical members shall not exceed  $\frac{1}{2}$  inch.
5. Decorative cutouts shall not exceed  $1 \frac{3}{4}$  inches in width.

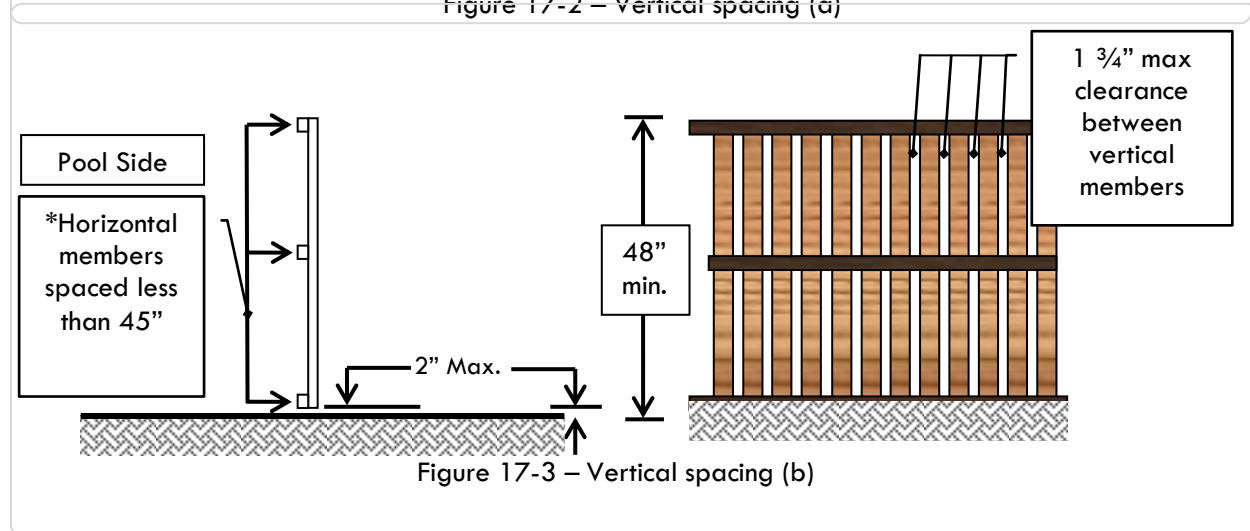
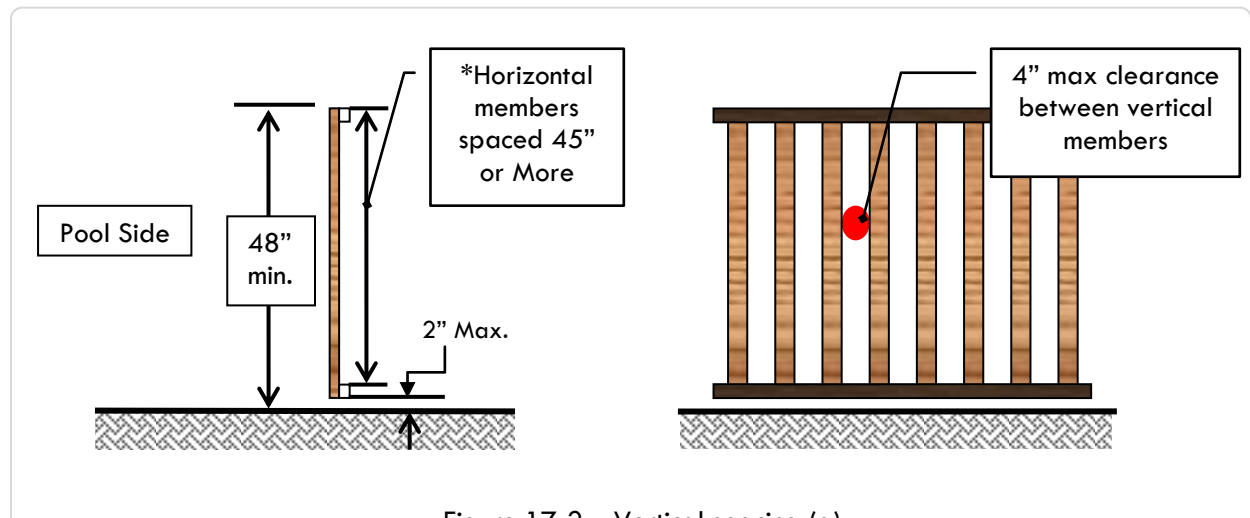
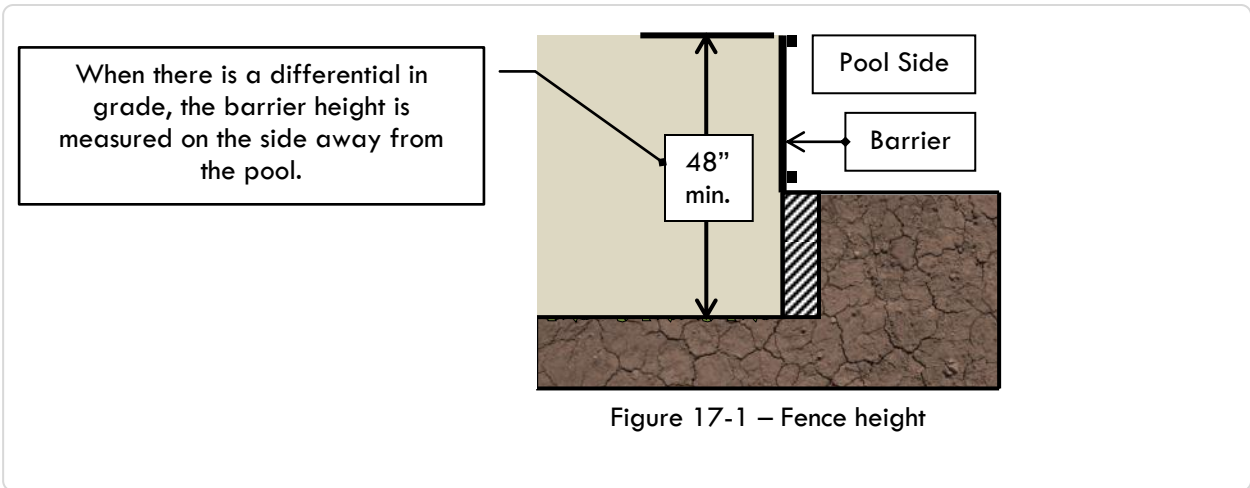

- Maximum mesh size for chain link fences shall be 1 1/4" inch square (1 3/4" maximum opening).

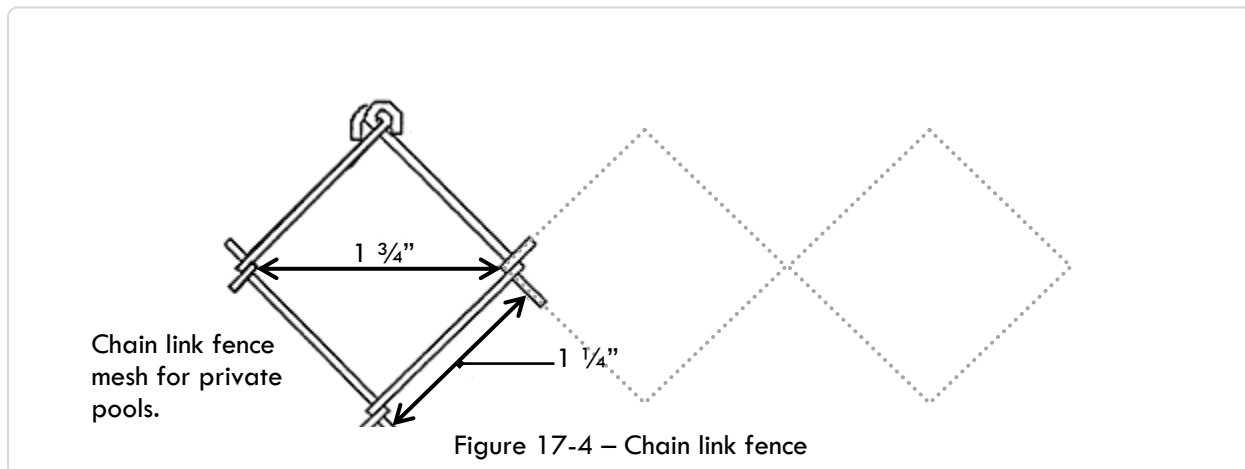

7. Where the barrier is composed of diagonal members, such as a lattice fence, the maximum opening formed by the diagonal members shall be not more than  $1 \frac{3}{4}$  inches.

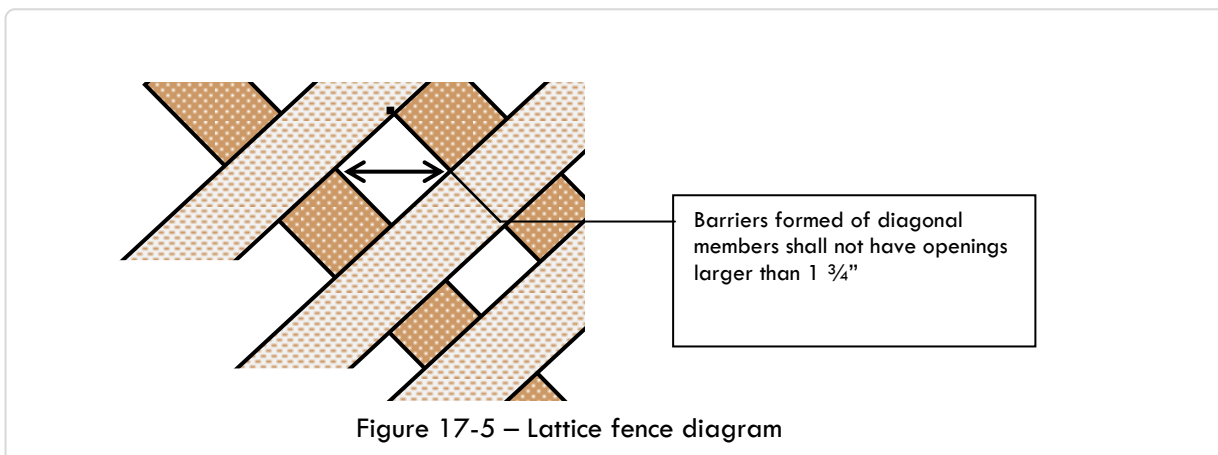

8. Access gates shall comply with the requirements of items 1 through 6 above, and shall be equipped to accommodate a locking device. Pedestrian access gates shall open outwards, away from the pool, and shall be self-closing and have a self-latching device. Where the release mechanism of the self-latching device is located less than 54 inches from grade:
- The release mechanism shall be located on the pool side of the gate at least 3 inches below the top of the gate.
  - The gate and barrier shall not have an opening greater than  $\frac{1}{2}$  inch within 18 inches of the release mechanism.
  - Any alternative mechanism which satisfies pool security may be allowed at the discretion of the *Building Official*.



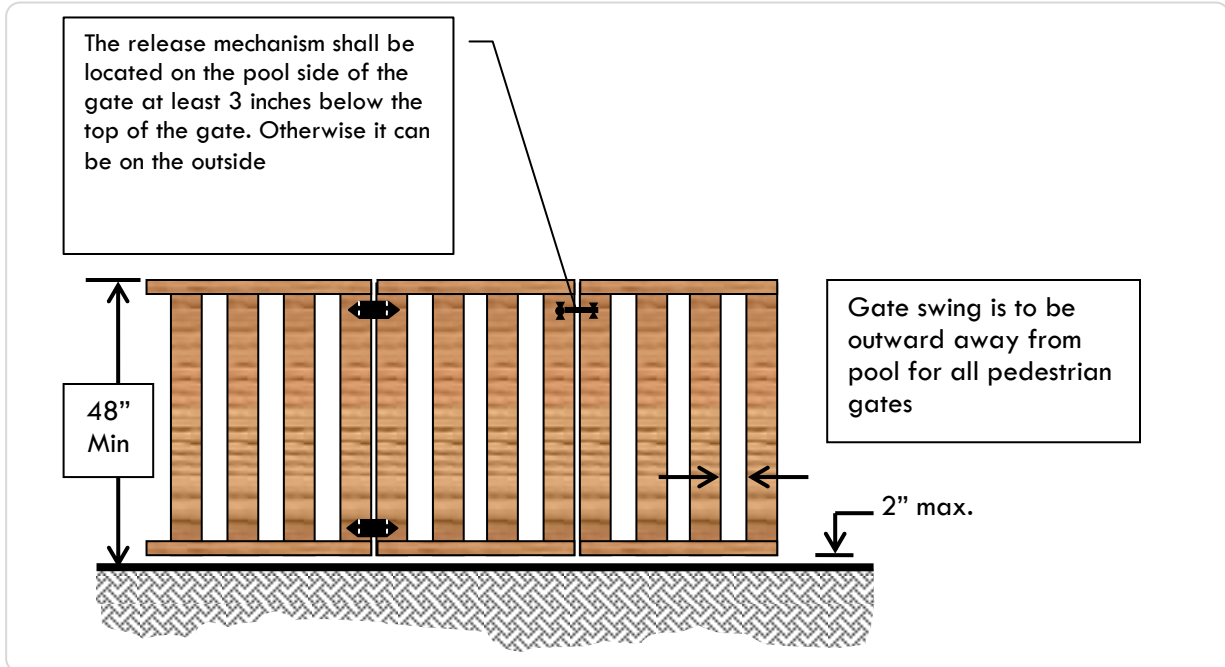

Figure 17-6 – Pool gate

9. Where a wall of a dwelling unit serves as part of the barrier and contains a door that provides direct access to the pool, one of the provisions listed below shall apply:
  - a) All doors with direct access to the pool through that wall shall be equipped with a self-closing and self-latching device with the release mechanism located a minimum of 48 inches above the floor;
  - b) All doors with direct access to the pool through that wall shall be equipped with an alarm which produces an audible warning when the door is opened. The audible warning shall commence **not more than 7 seconds** after the door is opened and shall sound continuously for a minimum of 30 seconds. The alarm shall have a minimum sound pressure rating of 85 dBA at 10 feet and the sound of the alarm shall be distinctive from other household sounds such as smoke alarms, telephones and door bells. The alarm shall automatically reset under all conditions. The alarm shall be equipped with manual means, such as touchpads or switches, to temporarily deactivate the alarm for a single opening from either direction. Such deactivation shall last for not more than 15 seconds. The deactivation touchpad's or switches shall be located at least 54 inches above the threshold of the door.

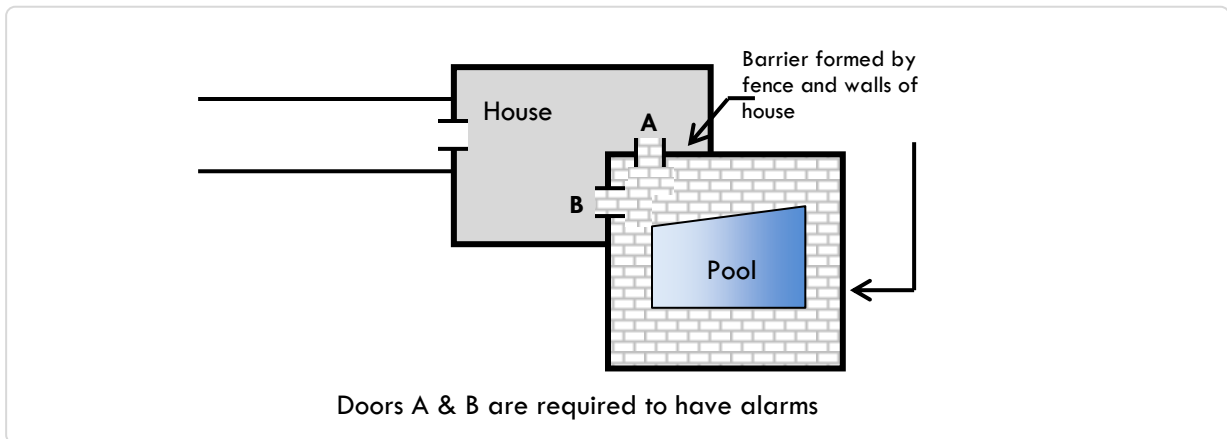

Figure 17-7 – Door alarm

10. Where the side of an above-ground pool structure is used as a barrier or where the barrier is mounted on top of the pool structure and the means of access is a fixed or removable ladder or steps, the ladder or steps shall be surrounded by a barrier which meets the requirements of items 1 through 8 above. A removable ladder shall not constitute an acceptable alternative to enclosure requirements.
11. All barriers shall be designed to resist a 200 lb concentrated load applied at any point and in any direction.

### **17.10.3 INDOOR PRIVATE SWIMMING POOL**

All walls surrounding an indoor private swimming pool shall comply with section 18.10.2, item 9.

### **17.10.4 PROHIBITED LOCATIONS**

Barriers shall be located so as to prohibit permanent structures, equipment or similar objects from being used to climb the barriers.

### **17.10.5 NATURAL BARRIERS**

Pool owners wishing to substitute a natural barrier in lieu of a fence enclosure, are required to provide "no less protection" than a fence with self-latching gate. Any property owner wishing to make such a substitute must seek approval. The site must be inspected and the decision as to the safety of the barrier will be made by the Building Official if they meet all the requirements of section 18.10.

Prior to issuance of Completion of Occupancy Certificate, barriers shall be approved at the discretion of the Building Official whether it is temporary or permanent.

### **17.10.6 DIVING BOARDS**

Minimum water depths and distances for diving hoppers for pools, based on board height above water, shall comply with Table 18.1. The maximum slope permitted between point D2 and the transition point shall not exceed one unit vertical to three units horizontal (1:3). D1 is the point directly under the end of the diving boards. D2 is the point at which the floor begins to slope upwards to the transition point.

Minimum Water Depths Based on Height of Diving Board			
Board Height above surface of pool surround	Minimum Depth directly under the end of the board	Minimum Horizontal Distance between D1 and D2	Minimum Depth at D2
1'-8"	6'-0"	7'-0"	7'-6"
2'-2"	6'-10"	7'-6"	8'-0"
2'-6"	7'-5"	8'-0"	8'-0"
3'-4"	8'-6"	9'-0"	9'-0"

Table 17.1 - Minimum Water Depths Based on Height of Diving Board

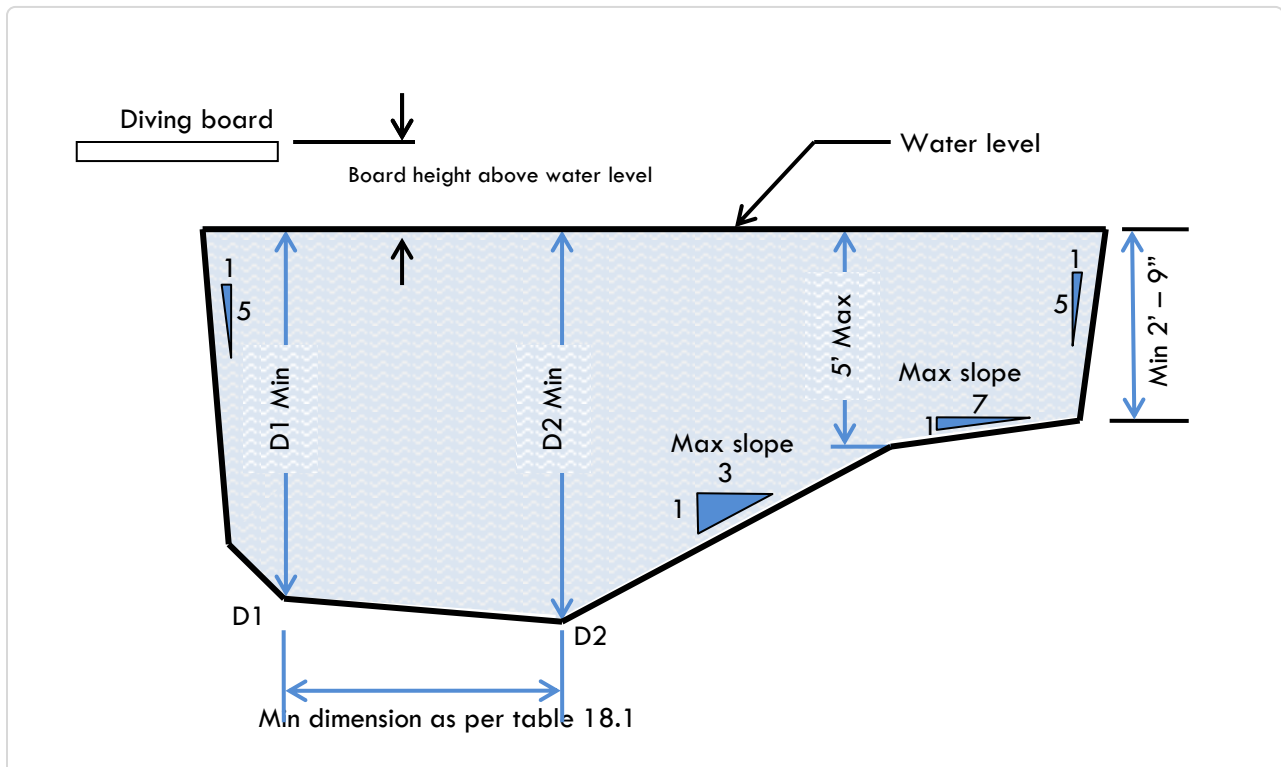

Figure 17-8 – Swimming Pool Required Dimensions

**17.11 VENTILATION OF INDOOR SWIMMING POOLS, SPAS AND HOT TUBS**

All areas containing indoor swimming pools, spas and hot tubs shall be provided with natural ventilation of at least 4% of the floor area of the pool room or with mechanical ventilation of a minimum of 0.5 cfm/square foot.

**17.12 ELECTRICAL REQUIREMENTS**

All electrical systems and materials shall be in accordance with Chapter 21 of this code and shall comply with the requirements of the latest adopted version of the National Electrical Code.

**17.13 LOCATION OF POOLS RELATIVE TO OVERHEAD WIRING**

No overhead wiring shall pass over the swimming pool or the area around the pool extending a distance of 10 feet from the inside wall of the pool, unless the clearances of Table 18.2 are maintained.

<b>Minimum Clearances of Overhead Conductors above Swimming Pools</b>			
	<b>Service drop cables rated up to 480 volts</b>	<b>Supply cables rated up to 4kV</b>	<b>Telephone wires, cable TV lines</b>
<b>Clearance to surface of water or top of pool decking</b>	<b>18ft</b>	<b>25ft</b>	<b>10ft</b>
<b>Clearance to top of diving board</b>	<b>14ft</b>	<b>16ft</b>	<b>10ft</b>

Table 17.2 - Minimum Clearances of Overhead Conductors above Swimming Pools

## 18 FIRE PROTECTION

---

### 18.1 EMERGENCY ESCAPES

Every sleeping room shall have at least one operable window or exterior door for emergency egress. The windows shall be able to be opened from the inside without the use of separate tools. The windows shall have a sill height of not more than 44" above the floor. The minimum clear height shall be 24", and the minimum clear width shall be 20". Bars, grills and screens placed over emergency escape windows shall be readily operable from the inside without the use of any tools. Window sills shall be less than 25' from finished grade or a second escape route is required.

### 18.2 SMOKE ALARMS

Smoke alarms must be audible in all parts of the house and installed per manufacturer's instructions.

#### 18.2.1 REQUIRED LOCATION

Smoke alarms shall be installed in the following locations:

#### 18.2.2 NEW CONSTRUCTION

1. In each sleeping room.
2. Outside of each separate sleeping area in the immediate vicinity of the bedrooms.
3. On each additional story of the dwelling, including basements and habitable attics, but not crawl spaces and uninhabitable attics. In dwellings or dwelling units with split levels and without an intervening door between the adjacent levels, a smoke alarm installed on the upper level shall suffice for the adjacent lower level provided that the lower level is less than one full story below the upper level.

When more than one smoke alarm is required to be installed within an individual dwelling unit, the alarm devices shall be interconnected in such a manner that the activation of one alarm will activate all of the alarms in the unit. ***Manufacturer's instructions must be followed for proper installation.***

#### 18.2.3 ALTERATIONS, REPAIRS OR ADDITIONS

When alterations, repairs or additions require a permit, or when one or more sleeping rooms are added or created in existing dwellings, the individual dwelling unit shall be provided with smoke alarms located as required for new dwellings.

#### Exceptions:

- Work on the exterior which does not require entry into the interior for inspection, such as roofing, siding, window replacements, decks and detached buildings.
- Installation, alteration or repairs of plumbing or mechanical systems.

The smoke alarms are not required to be interconnected unless remodeling considerations require removal of the appropriate wall and ceiling coverings to facilitate concealed interconnected wiring.

A hardwired power supply with battery backup is recommended. All new construction shall be equipped with hardwired alarms as per section 19.2.2 and 19.2.3.

#### **18.2.4 ALARM DEVICE LOCATION/HEAT DETECTION DEVICES**

Alarm devices which are required to cover areas with fireplaces, furnaces, space heaters and water pumps, in addition to kitchens and garages subjected to exhaust fumes shall be Heat detection devices

#### **18.3 MINIMUM SIGNALING INTENSITY**

All alarm sounding appliances shall have a minimum rating of 85 dBA at 10 feet.

#### **18.4 POWER SOURCE**

Smoke alarms shall receive their primary power from the building wiring, and when primary power is interrupted, shall receive power from a battery. Wiring shall be permanent and without a disconnecting switch other than those required for overcurrent protection. Smoke alarms shall be interconnected.

##### Exceptions:

1. Smoke alarms shall be permitted to be battery operated when installed in buildings without commercial power (public utility).
2. Smoke alarms in existing areas shall not be required to be interconnected and hardwired where the alterations or repairs do not result in the removal of interior wall or ceiling finishes exposing the structure. If an attic, crawlspace or basement is available which could provide access, the smoke alarms shall be hardwired and interconnected.

#### **18.4.1 INSTALLATION**

Smoke alarms shall be mounted on the ceiling at least 4 inches from a wall or on the wall within 12" of the ceiling but not closer than 4" to the ceiling. Where tray ceilings or sloped ceilings are provided, the alarms shall be located on the high point of the ceiling.

#### **18.4.2 MONITORED BATTERY TYPE SMOKE ALARM**

Where, during renovation of an existing building, it is deemed impractical by the Building Official to hardwire smoke alarms in accordance with section 19.2.3 then a self contained battery type smoke alarms shall be used. They shall meet the following requirements:

- a) The battery shall be non replaceable and its life shall be 10 years or greater, including monthly testing;
- b) A distinctive audible trouble signal shall be given before the battery is incapable of operating the device for alarm purposes. This signal shall sound at least once every minute for 7 consecutive days; and
- c) The battery shall be capable of providing an alarm signal at the specified intensity for 4 minutes followed by not less than 7 days of trouble signal operation.

**18.4.3 APPROVAL**

All devices shall be manufactured by an approved and or/listed agency in accordance with UL or ULC and shall be used for the purposes for which they are intended.

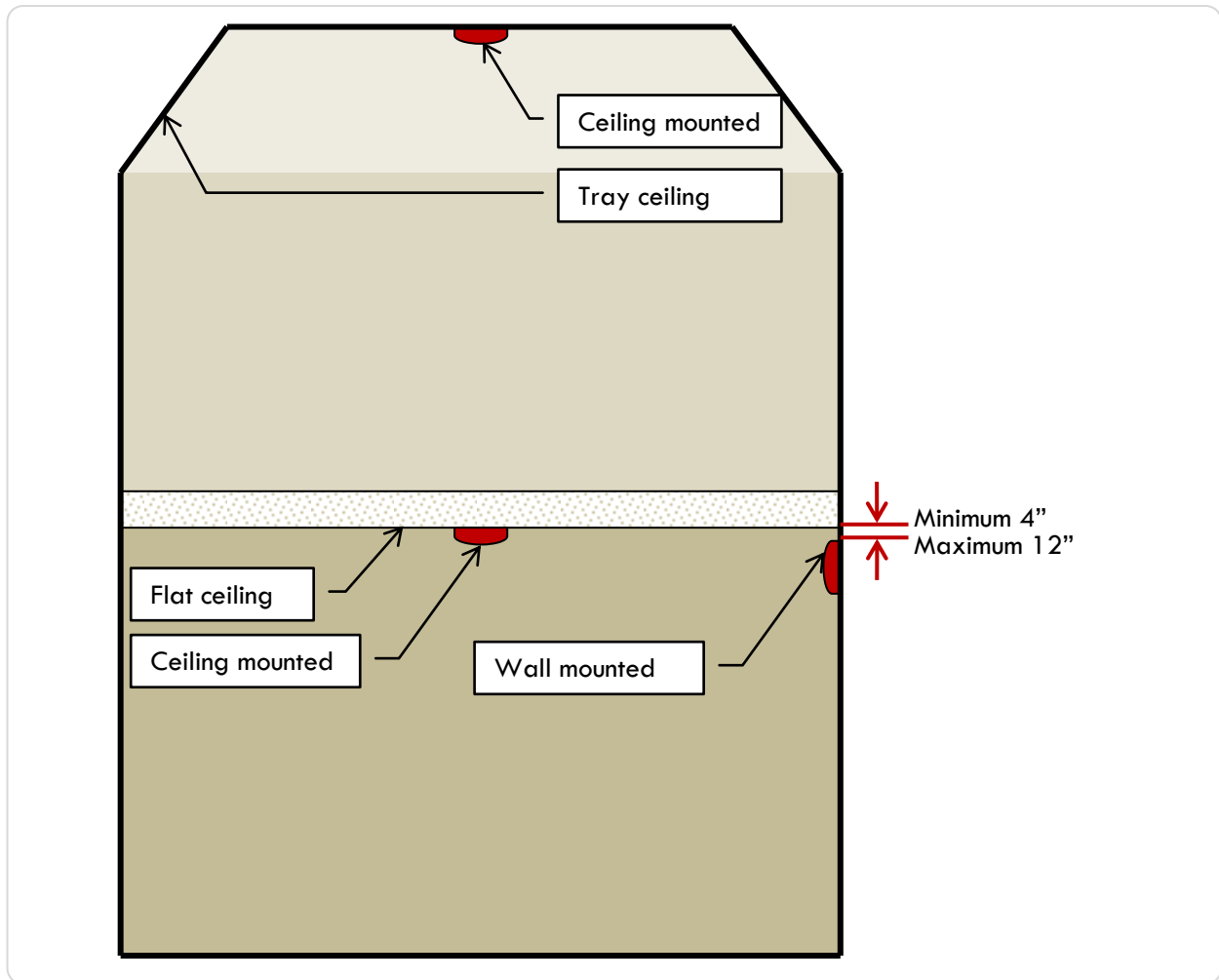

Figure 18-1 – Smoke alarm locations

**18.5 DWELLING UNIT SEPARATIONS**

Separate *dwelling* units that are under one ownership shall be separated from one another by wall and/or floor/ceiling assemblies of not less than 1 hour. Fire resistive floor/ceiling assemblies shall extend to and be tight against the exterior wall. Wall assemblies shall extend to the underside of the roof sheathing and shall be securely fixed thereto.

**18.5.1 WALL ASSEMBLIES**

The following wall assemblies shall be considered to provide the required 1 hour fire rating for non loadbearing walls:

- a) 4" thick hollow concrete block walls with ½" thick plaster either side;
- b) 4" solid grouted concrete block walls;
- c) 6" thick hollow concrete block walls;

- d) 2"x4" timber studs @ 16" c/c with  $\frac{5}{8}$ " thick fire rated gypsum board either side;
- e) 2"x4" timber studs @ 16" c/c with  $\frac{1}{2}$ " thick regular gypsum board either side and faced with  $\frac{1}{2}$ " of 1:2 gauge gypsum-sand plaster;
- f) 3- $\frac{5}{8}$ " wide metal studs at 24" c/c with  $\frac{5}{8}$ " thick fire rated gypsum board either side; or,
- g) 2 $\frac{1}{2}$ " wide metal studs at 24" c/c with  $\frac{1}{2}$ " thick regular gypsum board either side and faced with  $\frac{1}{2}$ " of 1:2 gauge gypsum-sand plaster.

## **18.6 FLOOR ASSEMBLIES**

The following assemblies shall be considered to provide the required 1 hour fire rating for floor assemblies:

- a) Reinforced concrete cast in-situ slabs in accordance with chapter 7.
- b) Reinforced concrete metal deck floor slabs in accordance with their individual UL ratings.
- c) Timber floors in accordance with chapter 7 with a minimum of  $\frac{1}{2}$ " thick regular gypsum board to the underside of the joists and plastered with  $\frac{1}{2}$ " of 1:2 gypsum-sand plaster.
- d) Timber floors in accordance with chapter 7 with a minimum of  $\frac{5}{8}$ " thick fire rated gypsum board to the underside of the joists.

### **18.6.1 DOORS THROUGH FIRE SEPARATION WALLS**

The door shall be constructed of 1  $\frac{3}{4}$ " solid core wood with a 1" rebate to the frame or another approved fire door assembly with  $\frac{3}{4}$  hour fire rating. The doors shall be equipped with self closing devices.

## **18.7 PARTY WALLS/FIRE WALLS**

### **18.7.1 GENERAL**

Separately owned attached houses or townhouses/condominiums that are attached, shall be separated by party walls with a minimum fire rating of 2 hours. These common walls shall extend from the foundation to the underside of the roof and extend the full length of the wall. An 8" unfilled masonry wall with  $\frac{1}{2}$ " thick plaster either side shall be considered to provide the necessary 2 hour resistance. Where services such as plumbing and ducting are installed in the wall, it shall be increased to a minimum of 10" block.

### **18.7.2 FIRE DOORS**

Any doors that penetrate through fire walls shall be of minimum 1  $\frac{1}{2}$  hour fire assembly rating and shall be equipped with self closing devices.

### **18.7.3 COMBUSTIBLE FRAMING**

Combustible framing is not permitted in party walls.



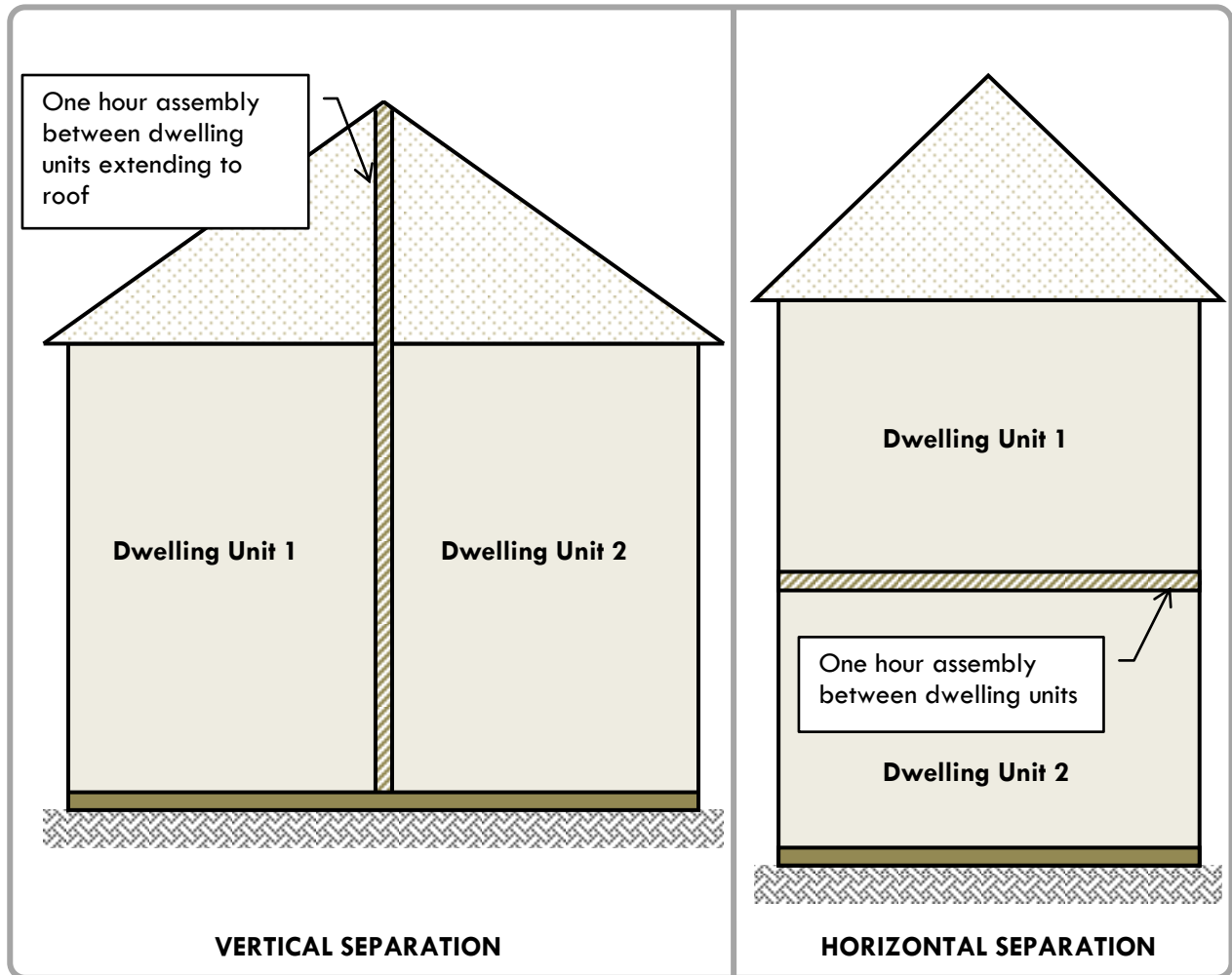

Figure 18-2 – Fire separation between dwelling units that are under one ownership

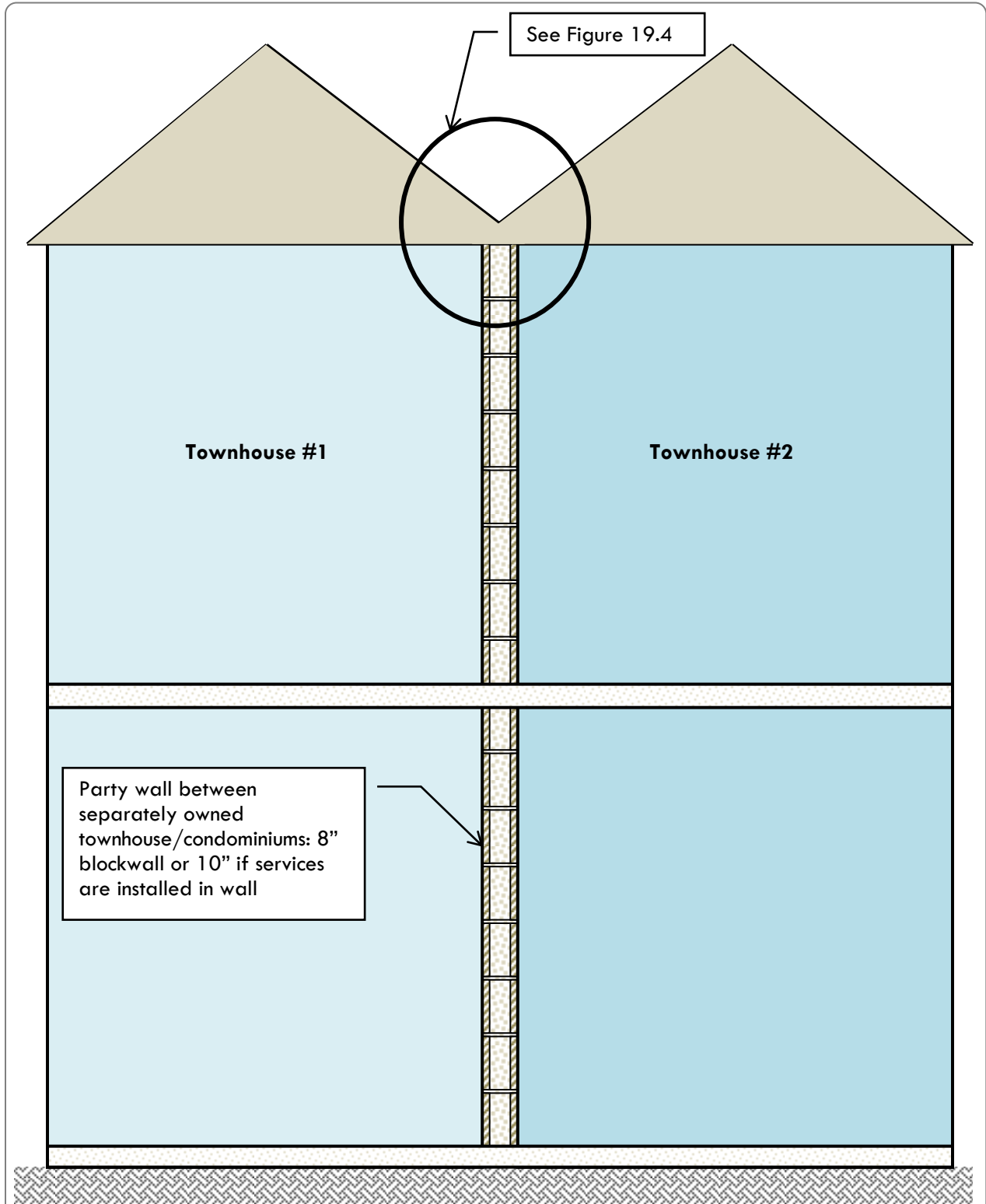

Figure 18-3 – Fire separation between dwelling units that are separately owned

#### 18.7.4 COMBUSTIBLE ROOFS CONSTRUCTION

The roofing at a party wall shall comply with the following requirements:

- a) the roof covering shall be constructed of approved non combustible material with a minimum class C in accordance with ASTM E108;
- b) the wall shall be adequately fire stopped at the junction with the roof; and,
- c) No combustible material shall extend through the wall.

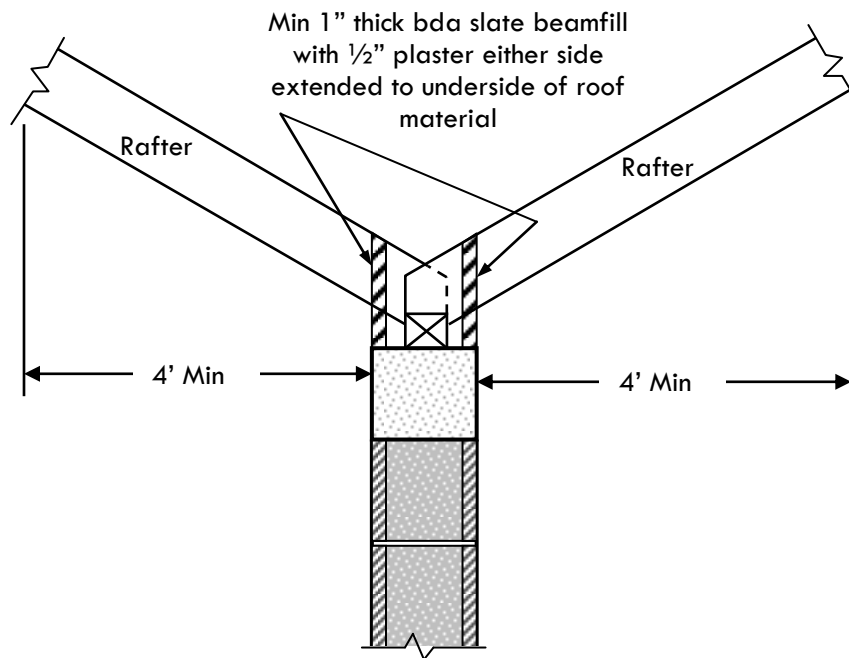

Figure 18-4 – Firestopping requirements for shared party wall

#### 18.7.5 ELECTRICAL OUTLET BOXES

Opening in party walls for approved metallic electrical boxes are permitted, however they shall not exceed 16 square inches in area and the aggregate surface area of the boxes shall not exceed 100 square inches for 100 square feet of wall area. Outlet boxes on opposite sides of the assembly shall be separated by a horizontal distance of not less than 24 inches. Electrical boxes of another type of material are permitted provided that such boxes are approved for use in fire resistance rated assemblies and installed in accordance with the tested assembly.

#### 18.7.6 SERVICES IN PARTY WALL

No common plumbing pipes, electrical conduits, or ventilation or exhaust ducting shall serve dwelling units either side of the party wall. All service lines in the party wall shall be metal or alternatively, if plastic, encased in a minimum of 4" of concrete for its entire length. Where plumbing lines or mechanical vents are laid in a party wall, the wall shall be a minimum of 10" in width.

**18.8 PENETRATIONS**

All penetrations through fire separation assemblies or party walls listed in sections 19.5, 19.7, and 19.9 shall be sealed, lined, insulated or otherwise treated to maintain the required ratings.

**18.9 GARAGES****18.9.1 FIRE SEPARATION**

Garages located beneath or adjacent to residential buildings shall have 1-hour fire resistive partitions, floors and ceilings separating the garage space from the interior spaces

**18.9.2 DOORS**

The sills of all door openings between the garage and interior spaces shall be raised a minimum of 4" above the garage floor. The doors shall be equipped with self closing devices and shall open into the garage. The door shall not access a room intended for sleeping.

**18.9.3 FLOOR SURFACE**

The floor finish of garages shall be of concrete or other approved noncombustible material.

**18.9.4 APPLIANCES IN GARAGES**

Electrical appliances capable of generating a spark, such as water pumps, shall be installed on a platform a minimum of 18" above the floor level of the garage. Alternatively, where such appliances are enclosed in separate compartments having access only from the outside of the garage, they may be installed at floor level.

**18.10 INTERIOR FINISH**

Interior finish on walls and ceilings of all spaces within the dwelling unit shall be not less than Class III in accordance with the Bermuda Commercial Building Code with a maximum flame spread rating of 200 and a maximum smoke-developed rating of 50 when tested in accordance with the latest version of ASTM E84. In addition, the interior finish shall be applied or otherwise fastened in such a manner that the materials will not readily become detached when subjected to room temperatures of 200 degrees F for not less than 30 minutes.

**18.11 FIRE EXTINGUISHERS**

At least one portable fire extinguisher shall be installed in every kitchen of a dwelling unit and all attached garages. The fire extinguisher shall bear the mark of an approved agency, shall have a minimum capacity of 2 ½ lb, and be of type A, B and C.

(Note: Type A extinguishers are intended for wood, paper or cloth fires, Type B extinguishers are intended for flammable liquid fires, and type C extinguishers are intended for electrical fires).

**18.12 ACCESS FOR FIRE VEHICLES**

All residential driveways shall be so constructed that a minimum width of 10 feet between gates and 12 feet of hardstanding is provided and maintained to allow the necessary accessibility for fire fighting vehicles. Where all parts of the ground floor of the dwelling are within 150 feet of a road,

these accessibility requirements for the driveway of the individual dwelling will not be mandatory but are still recommended. The maximum gradient of driveway should not exceed 1 in 8.75.

All new residential subdivisions shall have access roads to the individual dwelling units a minimum of 12 feet in width with a minimum clearance height of 15 feet.

All roads, together with any manholes and public service utility pits, shall be so designed to carry a fire appliance with a gross weight of 12 tons.



## 19 MECHANICAL VENTILATION

### 19.1 GENERAL

Every space for human occupancy shall be ventilated by natural means in accordance with section 4.11, or by mechanical ventilation in accordance with this chapter.

### 19.2 MECHANICAL VENTILATION

Where natural ventilation is not provided to a habitable or ancillary room, in accordance with section 4.11, the room shall be provided with a mechanical ventilation system in accordance with Tables 20.1 and 20.2. Mechanical ventilation shall consist of a method providing both supply and exhaust air. The amount of supply air shall be approximately equal to the amount of exhaust air.

Minimum Mechanical Fresh Air Ventilation rates (Intake/Supply Air)	
Location	Outdoor Ventilation Air
Living rooms, dining rooms, bedrooms	10cfm per 100sq ft floor area
Laundry, basement, recreation room	5cfm per 100 sq ft floor area
Swimming Pool areas	50cfm per 100 sq ft floor area

Table 19.1 - Minimum Mechanical Fresh Air Ventilation rates (Intake/Supply Air)

Minimum Mechanical Exhaust Rates	
Location	Outdoor Ventilation Air
Kitchen	100cfm
Bathrooms , water closet	50cfm
Garage	100cfm per car

Table 19.2 - Minimum Mechanical Exhaust Rates

#### Note:

1) The exhaust system for bathrooms and water closet rooms shall be separate and distinct from any other ventilation/exhaust system installed for other purposes. Exhausts shall be vented directly to the outside.

### 19.3 INTAKE OPENINGS

Mechanical air intakes shall be located a minimum of 10 feet from contaminant sources such as mechanical exhausts, chimneys, plumbing vents, roads or parking lots.

### 19.4 EXHAUST OPENINGS

The air removed by every mechanical exhaust system shall be discharged outdoors at a point where it will not cause a nuisance and from which it cannot be readily drawn into a ventilating system. Exhaust air shall not be directed within 5 feet of window openings, adjacent properties and/or roads.

**19.5      OUTSIDE OPENING PROTECTION**

Air exhaust and intake openings located in exterior walls shall be protected with corrosion resistant screens, louvers or grilles.

**19.6      CLOTHES DRYER EXHAUST**

Clothes dryers shall be exhausted in accordance with the manufacturer's instructions. Dryer exhaust shall be independent of all other systems and shall convey the moisture and any other products of combustion to the outside of the building. The minimum diameter of the exhaust vent shall be at least the diameter of the appliance outlet. The maximum length of a 4" diameter exhaust vent shall be 25' from the dryer location to the termination point. A reduction in length of 2.5 feet for every 45 degree bend and 5 feet for every 90degree bend shall apply. When this length is exceeded, installations shall conform to manufacturer's installation instructions.

**19.7      KITCHEN COOKING APPLIANCES**

Where cooking appliances are provided with domestic exhaust hoods that discharge to the outdoors, hoods shall discharge through approved non-combustible ducts installed in accordance with the hood manufacturer's installation instructions.

**19.8      AIR CONDITIONERS**

Air conditioners shall be so installed such that the condensate from them does not drain into the potable water storage area. Air conditioners shall be installed to prevent condensation on any external surface of the unit, ductwork or piping. Units installed in uninhabited spaces shall have a separately drained, insulated emergency drain pan located under the unit a minimum of 3" in each dimension larger than the plan area of the unit. Condensate drains shall connect to sanitary, waste, vent, or grey water systems by an indirect connection only or to a soakaway area outside the building.



## 20 ELECTRICAL

---

The Bermuda Residential Electrical Building Code shall follow all the requirements of the Bermuda Electrical Code. This Code is drawn from NFPA 70 National Electrical Code, with exceptions detailed in the current Bermuda Building Code.

### 20.1 DEFINITIONS

**Accessible (as applied to equipment):** Admitting close approach; not guarded by locked doors, elevation, or other effective means.

**Accessible (as applied to wiring methods):** Capable of being removed or exposed without damaging the building structure or finish or not permanently closed in by the structure or finish of the building.

**Accessible, Readily (Readily Accessible):** Capable of being reached quickly for operation, renewal, or inspections without requiring those to whom ready access is requisite to climb over or remove obstacles or to resort to portable ladders, and so forth.

**Ampacity:** The current, in amperes, that a conductor can carry continuously under the conditions of use without exceeding its temperature rating.

**Appliance:** Utilization equipment, generally other than industrial, that is normally built in standardized sizes or types and is installed or connected as a unit to perform one or more functions such as clothes washing, air conditioning, food mixing, deep frying, and so forth.

**Automatic:** Self-acting, operating by its own mechanism when actuated by some impersonal influence, as, for example, a change in current, pressure, temperature, or mechanical configuration.

**Bonded (Bonding):** Connected to establish electrical continuity and conductivity.

**Bonding Jumper:** A reliable conductor to ensure the required electrical conductivity between metal parts required to be electrically connected.

**Bonding Jumper, Equipment:** The connection between two or more portions of the equipment grounding conductor.

**Bonding Jumper, Main:** The connection between the grounded circuit conductor and the equipment grounding conductor at the service.

**Branch Circuit:** The circuit conductors between the final overcurrent device protecting the circuit and the outlet(s).

**Branch Circuit, Appliance:** A branch circuit that supplies energy to one or more outlets to which appliances are to be connected and that has no permanently connected luminaires that are not a part of an appliance.

**Branch Circuit, General-Purpose:** A branch circuit that supplies two or more receptacles or outlets for lighting and appliances.

**Branch Circuit, Individual:** A branch circuit that supplies only one utilization equipment.

**Branch Circuit, Multiwire:** A branch circuit that consists of two or more ungrounded conductors that have a voltage between them, and a grounded conductor that has equal voltage between it and each ungrounded conductor of the circuit and that is connected to the neutral or grounded conductor of the system.

**Branch-Circuit Overcurrent Device:** A device capable of providing protection for service, feeder, and branch circuits and equipment over the full range of overcurrents between its rated current and its interrupting rating. Branch-circuit overcurrent protective devices are provided with interrupting ratings appropriate for the intended use but no less than 5,000 amperes.

**Cabinet:** An enclosure that is designed for either surface mounting or flush mounting and is provided with a frame, mat, or trim in which a swinging door or doors are or can be hung.

**Circuit Breaker:** A device designed to open and close a circuit by nonautomatic means and to open the circuit automatically on a predetermined overcurrent without damage to itself when properly applied within its rating.

**Clothes Closet:** A non-habitable room or space intended primarily for storage of garments and apparel.

**Concealed:** Rendered inaccessible by the structure or finish of the building. Wires in concealed raceways are considered concealed, even though they may become accessible by withdrawing them.

**Conductor, Bare:** A conductor having no covering or electrical insulation whatsoever.

**Conductor, Covered:** A conductor encased within material of composition or thickness that is not recognized by this *Code* as electrical insulation.

**Conductor, Insulated:** A conductor encased within material of composition and thickness that is recognized by this *Code* as electrical insulation.

**Connector, Pressure (Solderless):** A device that establishes a connection between two or more conductors or between one or more conductors and a terminal by means of mechanical pressure and without the use of solder.

**Continuous Load:** A load where the maximum current is expected to continue for 3 hours or more.

**Controller:** A device or group of devices that serves to govern, in some predetermined manner, the electric power delivered to the apparatus to which it is connected.

**Cooking Unit, Counter-Mounted:** A cooking appliance designed for mounting in or on a counter and consisting of one or more heating elements, internal wiring, and built-in or mountable controls.

**Copper-Clad Aluminum Conductors:** Conductors drawn from a copper-clad aluminum rod with the copper metallurgically bonded to an aluminum core. The copper forms a minimum of 10 percent of the cross-sectional area of a solid conductor or each strand of a stranded conductor.

**Cutout Box:** An enclosure designed for surface mounting that has swinging doors or covers secured directly to and telescoping with the walls of the box proper.

**Demand Factor:** The ratio of the maximum demand of a system, or part of a system, to the total connected load of a system or the part of the system under consideration.

**Device:** A unit of an electrical system that carries or controls electric energy as its principal function.

**Disconnecting Means:** A device, or group of devices, or other means by which the conductors of a circuit can be disconnected from their source of supply.

**Enclosed:** Surrounded by a case, housing, fence, or wall(s) that prevents persons from accidentally contacting energized parts.

**Enclosure:** The case or housing of apparatus, or the fence or walls surrounding an installation to prevent personnel from accidentally contacting energized parts or to protect the equipment from physical damage.

**Energized:** Electrically connected to, or is, a source of voltage.

**Equipment:** A general term, including material, fittings, devices, appliances, luminaires, apparatus, machinery, and the like used as a part of, or in connection with, an electrical installation.

**Exposed (as applied to live parts):** Capable of being inadvertently touched or approached nearer than a safe distance by a person. It is applied to parts that are not suitably guarded, isolated, or insulated.

**Exposed (as applied to wiring methods):** On or attached to the surface or behind panels designed to allow access.

**Feeder:** All circuit conductors between the service equipment, the source of a separately derived system, or other power supply source and the final branch-circuit overcurrent device.

**Fitting:** An accessory such as a locknut, bushing, or other part of a wiring system that is intended primarily to perform a mechanical rather than an electrical function.

**Garage:** A building or portion of a building in which one or more self-propelled vehicles can be kept for use, sale, storage, rental, repair, exhibition, or demonstration purposes.

**Ground:** The earth.

**Grounded (Grounding):** Connected (connecting) to ground or to a conductive body that extends the ground connection.

**Grounded, Solidly:** Connected to ground without inserting any resistor or impedance device.

**Grounded Conductor:** A system or circuit conductor that is intentionally grounded.

**Ground-Fault Circuit Interrupter (GFCI):** A device intended for the protection of personnel that functions to de-energize a circuit or portion thereof within an established period of time when a current to ground exceeds the values established for a Class A device.

**Ground-Fault Protection of Equipment:** A system intended to provide protection of equipment from damaging line-to-ground fault currents by operating to cause a disconnecting means to open all ungrounded conductors of the faulted circuit. This protection is provided at current levels less than those required to protect conductors from damage through the operation of a supply circuit overcurrent device.

**Grounding Conductor:** A conductor used to connect equipment or the grounded circuit of a wiring system to a grounding electrode or electrodes.

**Grounding Conductor, Equipment (EGC):** The conductive path installed to connect normally non-current carrying metal parts of equipment together and to the system grounded conductor or to the grounding electrode conductor, or both.

**Grounding Electrode:** A conducting object through which a direct connection to earth is established.

**Grounding Electrode Conductor:** A conductor used to connect the system grounded conductor or the equipment to a grounding electrode or to a point on the grounding electrode system.

**Identified (as applied to equipment):** Recognizable as suitable for the specific purpose, function, use, environment, application, and so forth, where described in a particular *Code* requirement.

**Interrupting Rating:** The highest current at rated voltage that a device is intended to interrupt under standard test conditions.

**Intersystem Bonding Termination:** A device that provides a means for connecting communications system(s) grounding conductor(s) and bonding conductor(s) at the service equipment or at the disconnecting means for buildings or structures supplied by a feeder or branch circuit.

**Isolated (as applied to location):** Not readily accessible to persons unless special means for access are used.

**Labeled:** Equipment or materials to which has been attached a label, symbol, or other identifying mark of an organization that is acceptable to the *Building Official* and concerned with product evaluation, that maintains periodic inspection of production of labeled equipment or materials, and by whose labeling the manufacturer indicates compliance with appropriate standards or performance in a specified manner.

**Lighting Outlet:** An outlet intended for the direct connection of a lampholder or luminaire.

**Live Parts:** Energized conductive components.

**Luminaire:** A complete lighting unit consisting of a light source such as a lamp or lamps, together with the parts designed to position the light source and connect it to the power supply. It may also include parts to protect the light source or the ballast or to distribute the light. A lampholder itself is not a luminaire.

**Neutral Conductor:** The conductor connected to the neutral point of a system that is intended to carry current under normal conditions.

**Neutral Point:** The common point on a wye-connection in a polyphase system or midpoint on a single-phase, 3-wire system, or midpoint of a single-phase portion of a 3-phase delta system, or a midpoint of a 3-wire, direct-current system.

**Outlet:** A point on the wiring system at which current is taken to supply utilization equipment.

**Overcurrent:** Any current in excess of the rated current of equipment or the ampacity of a conductor.

**Overload:** Operation of equipment in excess of normal, full-load rating, or of a conductor in excess of rated ampacity that, when it persists for a sufficient length of time, would cause damage or dangerous overheating. A fault, such as a short circuit or ground fault, is not an overload.

**Panelboard:** A single panel or group of panel units designed for assembly in the form of a single panel, including buses and automatic overcurrent devices, and equipped with or without switches for the control of light, heat, or power circuits; designed to be placed in a cabinet or cutout box placed in or against a wall, partition, or other support; and accessible only from the front.

**Raceway:** An enclosed channel of metal or non-metallic materials designed expressly for holding wires, cables, or busbars, with additional functions as permitted in this *Code*. Raceways include, but are not limited to, rigid metal conduit, rigid nonmetallic conduit, intermediate metal conduit, liquidtight flexible conduit, flexible metallic tubing, flexible metal conduit, electrical nonmetallic tubing, electrical metallic tubing, underfloor raceways, cellular concrete floor raceways, cellular metal floor raceways, surface raceways, wireways, and busways.

**Rainproof:** Constructed, protected, or treated so as to prevent rain from interfering with the successful operation of the apparatus under specified test conditions.

**Raintight:** Constructed or protected so that exposure to a beating rain will not result in the entrance of water under specified test conditions.

**Receptacle:** A receptacle is a contact device installed at the outlet for the connection of an attachment plug. A single receptacle is a single contact device with no other contact device on the same yoke. A multiple receptacle is two or more contact devices on the same yoke.

**Receptacle Outlet:** An outlet where one or more receptacles are installed.

**Sealable Equipment:** Equipment enclosed in a case or cabinet that is provided with a means of sealing or locking so that live parts cannot be made accessible without opening the enclosure. The equipment may or may not be operable without opening the enclosure.

**Service:** The conductors and equipment for delivering electric energy from the serving utility to the wiring system of the premises served.

**Service Cable:** Service conductors made up in the form of a cable.

**Service Conductors:** The conductors from the service point to the service disconnecting means.

**Service Drop:** The overhead service conductors from the last pole or other aerial support to and including the splices, if any, connecting to the service-entrance conductors at the building or other structure.

**Service-Entrance Conductors, Overhead System:** The service conductors between the terminals of the service equipment and a point usually outside the building, clear of building walls, where joined by tap or splice to the service drop.

**Service-Entrance Conductors, Underground System:** The service conductors between the terminals of the service equipment and the point of connection to the service lateral.

**Service Equipment:** The necessary equipment, usually consisting of a circuit breaker(s) or switch(es) and fuse(s) and their accessories, connected to the load end of service conductors to a building or other structure, or an otherwise designated area, and intended to constitute the main control and cutoff of the supply.

**Service Point:** The point of connection between the facilities of the serving utility and the premises wiring.

**Short-Circuit Current Rating:** The prospective symmetrical fault current at a nominal voltage to which an apparatus or system is able to be connected without sustaining damage exceeding defined acceptance criteria.

**Switch, General-Use:** A switch intended for use in general distribution and branch circuits. It is rated in amperes, and it is capable of interrupting its rated current at its rated voltage.

**Switch, Isolating:** A switch intended for isolating an electrical circuit from the source of power. It has no interrupting rating, and it is intended to be operated only after the circuit has been opened by some other means.

**Switch, Motor-Circuit:** A switch rated in horsepower that is capable of interrupting the maximum operating overload current of a motor of the same horsepower rating as the switch at the rated voltage.

**Ungrounded:** Not connected to ground or to a conductive body that extends the ground connection.

**Utilization Equipment:** Equipment that utilizes electric energy for electronic, electromechanical, chemical, heating, lighting, or similar purposes.

**Ventilated:** Provided with a means to permit circulation of air sufficient to remove an excess of heat, fumes, or vapours.

**Voltage, Nominal:** A nominal value assigned to a circuit or system for the purpose of conveniently designating its voltage class (e.g., 120/240 volts, 480Y/277 volts). The actual voltage at which a

circuit operates can vary from the nominal within a range that permits satisfactory operation of equipment.

**Voltage to Ground:** For grounded circuits, the voltage between the given conductor and that point or conductor of the circuit that is grounded; for ungrounded circuits, the greatest voltage between the given conductor and any other conductor of the circuit.

**Watertight:** Constructed so that moisture will not enter the enclosure under specified test conditions.

**Weatherproof.** Constructed or protected so that exposure to the weather will not interfere with successful operation.

## **20.2 SWIMMING POOLS, HOT TUBS, AND SIMILAR INSTALLATIONS: ELECTRICAL DEFINITIONS**

**Cord-and-Plug-Connected Lighting Assembly:** A lighting assembly consisting of a luminaire intended for installation in the wall of a spa, hot tub, or storable pool, and a cord-and-plug-connected transformer.

**Dry-Niche Luminaire:** A luminaire intended for installation in the wall of a pool or fountain in a niche that is sealed against the entry of pool water.

**Equipment, Fixed:** Equipment that is fastened or otherwise secured at a specific location.

**Equipment, Portable:** Equipment that is actually moved or can easily be moved from one place to another in normal use.

**Equipment, Stationary:** Equipment that is not easily moved from one place to another in normal use.

**Forming Shell:** A structure designed to support a wet-niche luminaire assembly and intended for mounting in a pool or fountain structure.

**Fountain:** Fountains, ornamental pools, display pools, and reflection pools. The definition does not include drinking fountains.

**Hydromassage Bathtub:** A permanently installed bathtub equipped with a recirculating piping system, pump, and associated equipment. It is designed so it can accept, circulate, and discharge water upon each use.

**Maximum Water Level:** The highest level that water can reach before it spills out.



**No-Niche Luminaire:** A luminaire intended for installation above or below the water without a niche.

**Packaged Spa or Hot Tub Equipment Assembly:** A factory-fabricated unit consisting of water-circulating, heating, and control equipment mounted on a common base, intended to operate a spa or hot tub. Equipment can include pumps, air blowers, heaters, lights, controls, sanitizer generators, and so forth.

**Permanently Installed Swimming Pools:** Those that are constructed in the ground or partially in the ground, and all others capable of holding water in a depth greater than 1.0 m (42 in.), and all pools installed inside of a building, regardless of water depth, whether or not served by electrical circuits of any nature.

**Pool:** Manufactured or field-constructed equipment designed to contain water on a permanent or semipermanent basis and used for swimming, wading, immersion, or therapeutic purposes.

**Pool Cover, Electrically Operated:** Motor-driven equipment designed to cover and uncover the water surface of a pool by means of a flexible sheet or rigid frame.

**Self-Contained Spa or Hot Tub:** Factory-fabricated unit consisting of a spa or hot tub vessel with all water circulating, heating, and control equipment integral to the unit. Equipment can include pumps, air blowers, heaters, lights, controls, sanitizer generators, and so forth.

**Spa or Hot Tub:** A hydromassage pool or tub for recreational or therapeutic use, designed for immersion of users, and usually having a filter, heater, and motor-driven blower. It may be installed indoors or outdoors, on the ground or supporting structure, or in the ground or supporting structure. Generally, a spa or hot tub is not designed or intended to have its contents drained or discharged after each use.

**Storable Swimming Pool:** Those that are constructed on or above the ground and are capable of holding water to a maximum depth of 1.0 m (42 in.), or a pool with nonmetallic, molded polymeric walls or inflatable fabric walls regardless of dimension.

**Through-Wall Lighting Assembly:** A lighting assembly intended for installation above grade, on or through the wall of a pool, consisting of two interconnected groups of components separated by the pool wall.

**Wet-Niche Luminaire:** A luminaire intended for installation in a forming shell mounted in a pool or fountain structure where the luminaire will be completely surrounded by water.

### **20.3      GENERAL**

All electrical wiring and equipment installation shall be strictly in accordance with the currently adopted version of the National Electrical Code (NEC), produced by the National Fire Protection Association (NFPA 70). The sections in this chapter are to be read in conjunction with the National Electrical Code. This chapter covers equipment, fixtures and methods commonly used in residential dwellings. The omission from this chapter of any material or method of construction provided for in the referenced standard NFPA 70 shall not be constructed as detracting from the need to comply with the NEC. Electrical systems, equipment or components not specifically covered in this chapter shall comply with the NEC.

### **20.4      PERMITS, INSPECTIONS & APPROVALS**

No installation or renewal of electrical wiring and/or equipment shall commence prior to the issuance of a building permit. The supply of permanent current shall not be made available to an electrical wiring installation until the certificate of completion and occupancy or the partial certificate of occupancy has been issued and a copy forwarded to the Bermuda Electric Light Company.

No works including all roughing in work for ceilings walls and slabs shall be concealed or placed in operation until permission to do so has been given by the *Building Official*. In addition to permanent installations, temporary installations shall be inspected by a *Building Official*.

### **20.5      DEFECTIVE WIRING**

If, upon inspection, an electrical wiring system is found to be defective and unsafe, the *Building Official* may require the use of the system to be discontinued until it has been brought up to the relevant code requirements.

### **20.6      LISTING AND LABELING**

Electrical materials, components, devices, fixtures and equipment shall be listed for the application and shall bear the label of an *approved* agency and shall be installed in accordance with the manufacturer's installation instructions.

### **20.7      MECHANICAL EXECUTION OF WORK**

Electrical equipment shall be installed in a neat and workmanlike manner.

### **20.8      CONCRETE ENCASED ELECTRODE**

An electrode should be encased by at least 2" of concrete, located horizontally near the bottom or vertically, and within that portion of concrete foundation that is in direct contact with the earth, consisting of at least 20ft of one or more bare or galvanized or other electrically conductive coated steel reinforcing bars or rods of not less than ½" in diameter, or consisting of at least 20ft of bare copper conductor not smaller than #4 AWG. The #4 AWG wire must terminate at the utility.

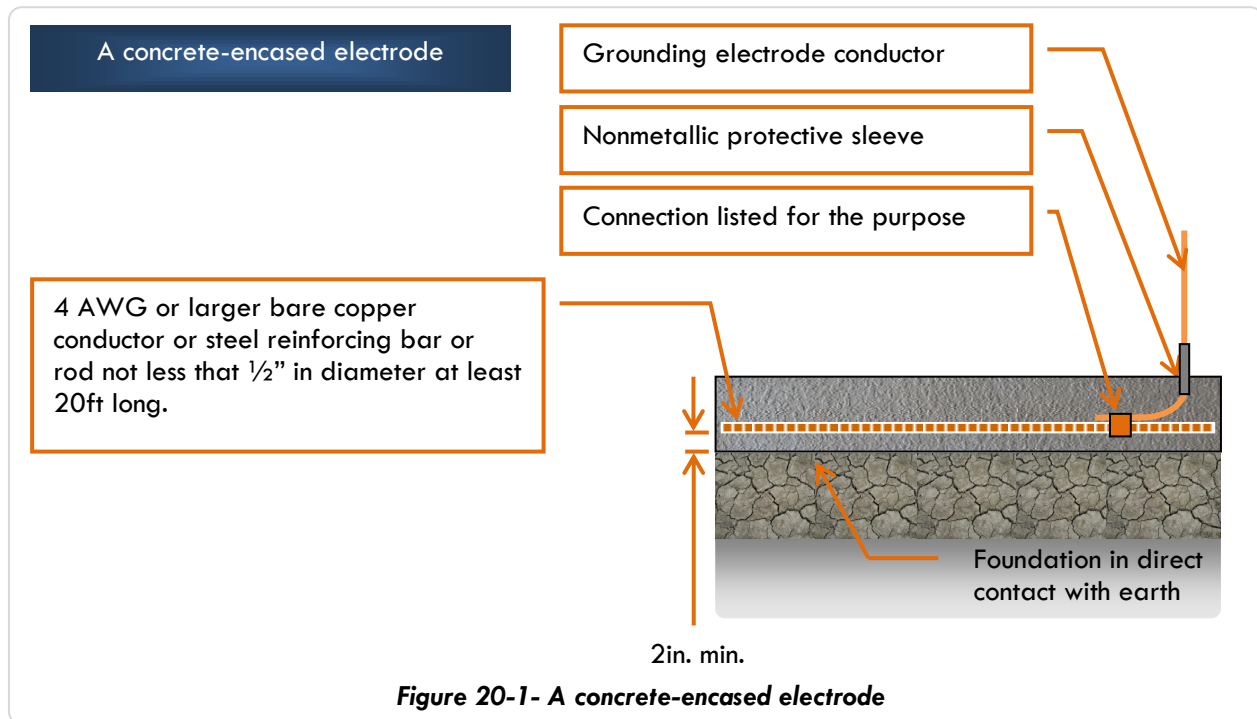

## 20.9 RECEPTACLE OUTLETS

### 20.9.1 DWELLING UNIT RECEPTACLE OUTLETS

This section provides requirements for 125-volt, 15-ampere and 20-ampere receptacle outlets.

### 20.9.2 TAMPER- RESISTANT RECEPTACLE IN DWELLING UNITS

All 125 – volt, and 15 –ampere and 20- ampere receptacles shall be listed tamper-resistant.

### 20.9.3 GENERAL

All new and renovated dwellings shall be fitted with tamper-resistant (TR) receptacles.

#### What are tamper -resistant electrical receptacles and what is the new requirement?



**Figure 20-2 – Examples of tamper –resistant receptacles**

The 2008 National Electrical Code® (NEC®) requires new and renovated dwellings to have tamper-resistant (TR) receptacles. These receptacles have spring-loaded shutters that close off the contact openings, or slots, of the receptacles. When a plug is inserted into the receptacle, both springs are compressed and the shutters then open, allowing for the metal prongs to make contact to create an electrical circuit. Because both springs must be compressed at the same time, the shutters do not open when a child attempts to insert an object into only one contact opening, and there is no contact with electricity. Tamper-resistant receptacles are an important next step to making the home a safer place for children.

Figure 21.3 below describes the reasons for enforcing the use of tamper resistant receptacles in dwelling units.

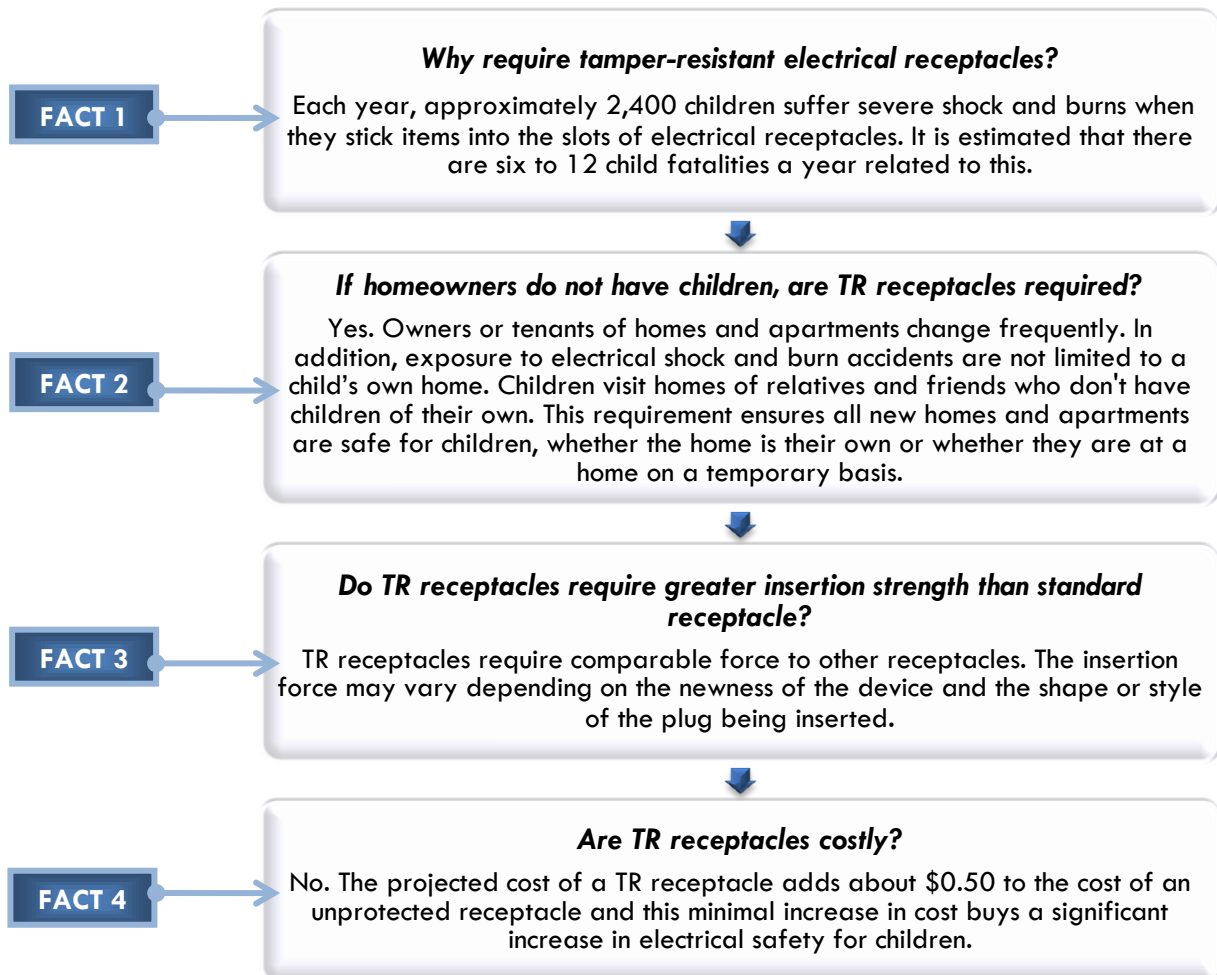

Figure 20-3 – Tamper Resistant Fact Sheet

Sources: 2008 NFPA 70® (National Electrical Code)

#### 20.9.4 GENERAL

In every kitchen and *habitable* room in a *dwelling unit*, receptacle outlets shall be installed so that no point along the floor line in any wall space is more than 6 feet, measured horizontally, from any outlet. The wall space excludes doorways and fireplace openings. Receptacle outlets shall, as far as practical, be spaced equal distances apart. The receptacles shall be a maximum of 5'-6" above the floor. Receptacle outlets shall be in addition to any receptacle that is part of any lighting fixture or appliance or any located in cabinets or cupboards (Figure 21.4).

Receptacle outlets in floors shall not be counted as part of the required number of receptacle outlets unless they are located within 18" of the wall. All face up/floor mounted receptacles shall be approved for the location.

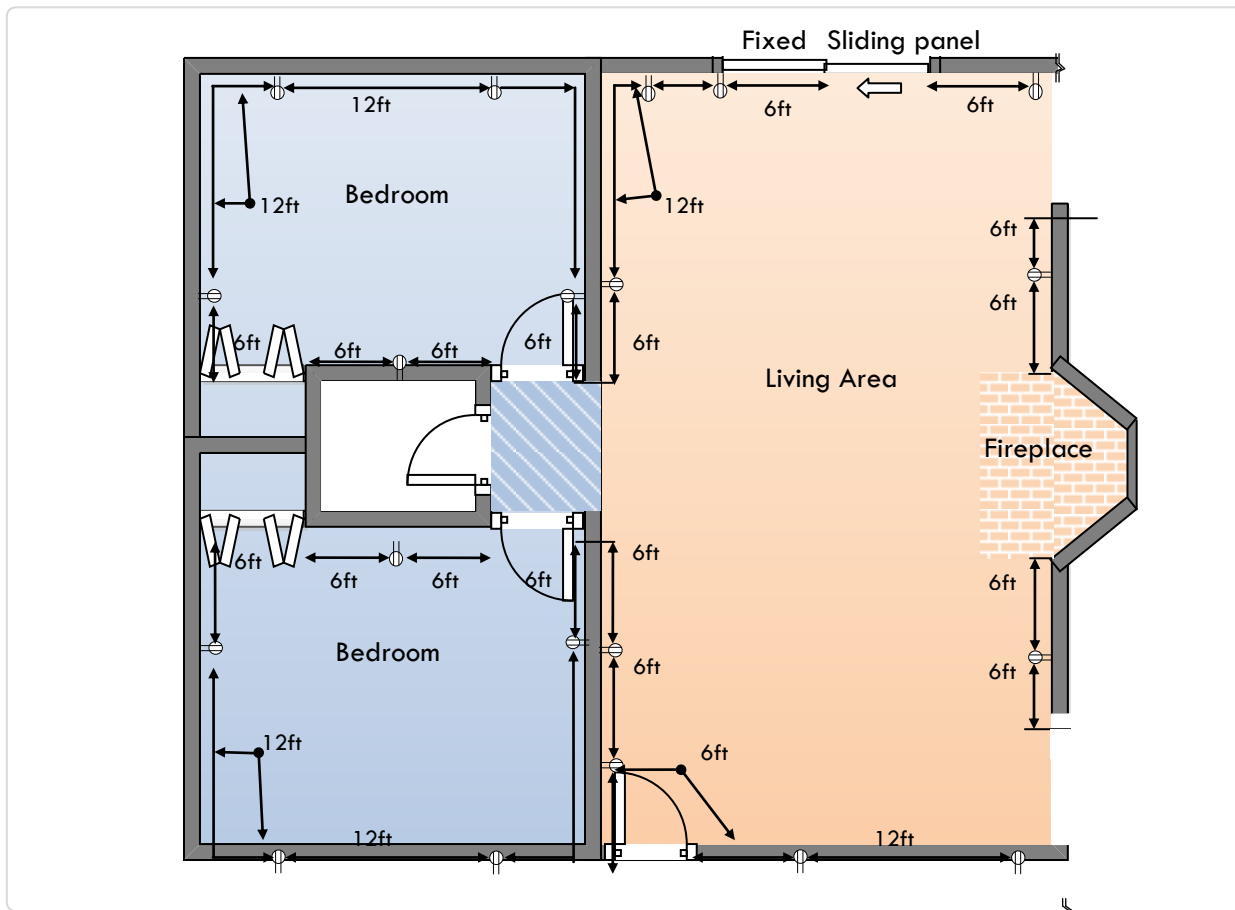

Figure 20-4 - Dimensions shown are maximum spacing of general purpose receptacle.

Any wall space of 24" or greater must have a receptacle (Figure 21.5).

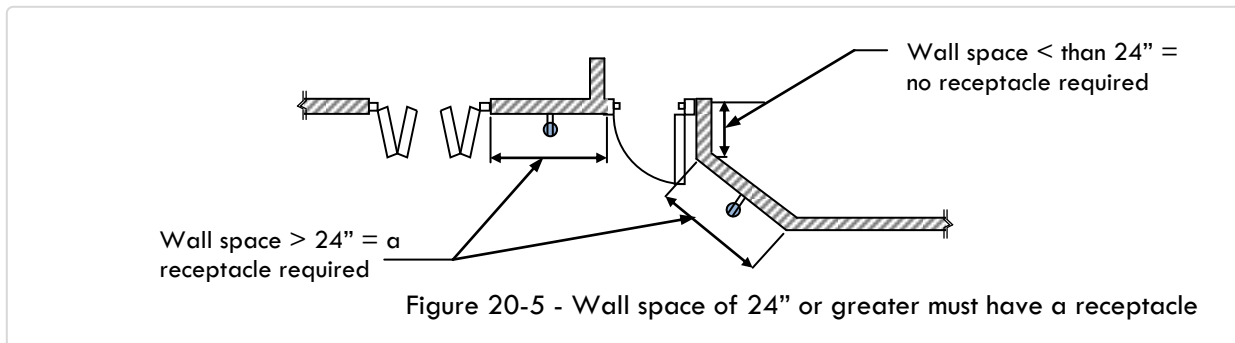

Figure 20-5 - Wall space of 24" or greater must have a receptacle

**20.9.5 SMALL APPLIANCES**

In the kitchen, pantry, breakfast room, dining room or similar area of a *dwelling unit*, two or more 20-ampere small appliance branch circuits shall serve all receptacle outlets located in cabinets, in cupboards or above countertops and receptacle outlets for refrigeration equipment or other appliances. Such circuits, whether two or more are used, shall serve no other outlets.

### 20.9.6 COUNTERTOP RECEPTACLES

In kitchens and dining rooms, GFCI protected receptacle outlets shall be installed in accordance with the following conditions (1 through 6):

1. Where a range, counter-mounted cooking unit, or sink is installed in an island or peninsular countertop, and the width of the counter behind the range, counter-mounted cooking unit, or sink is less than 12", the countertop space is considered to be two countertop spaces.

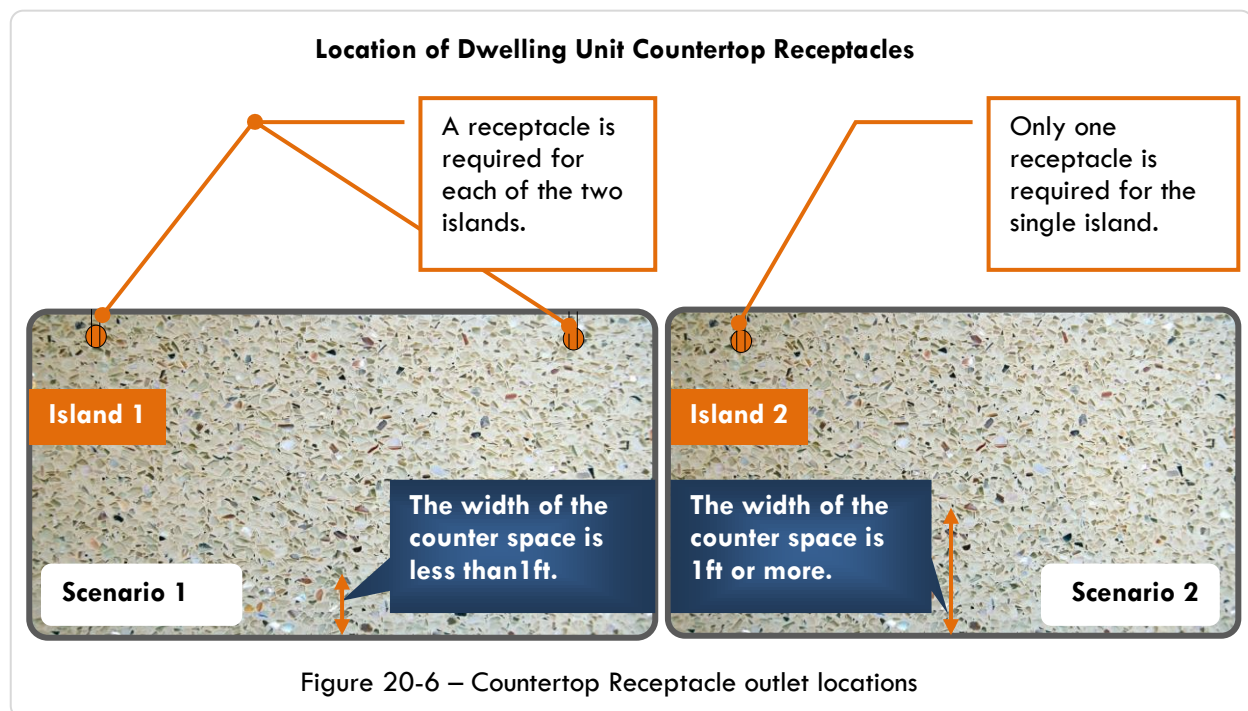

2. **Wall Counter space:** at each wall counter of 12" or wider, receptacles shall be installed so that no point along the wall line is more than 24" measured horizontally from a receptacle outlet.
  - \* *For applicable wall counter spaces, this means the first receptacle must not be located more 24" (2ft) from the edge of the counter space, and the next receptacle can be no more than 48" (4ft) from the first one, and so on along the counter space.*

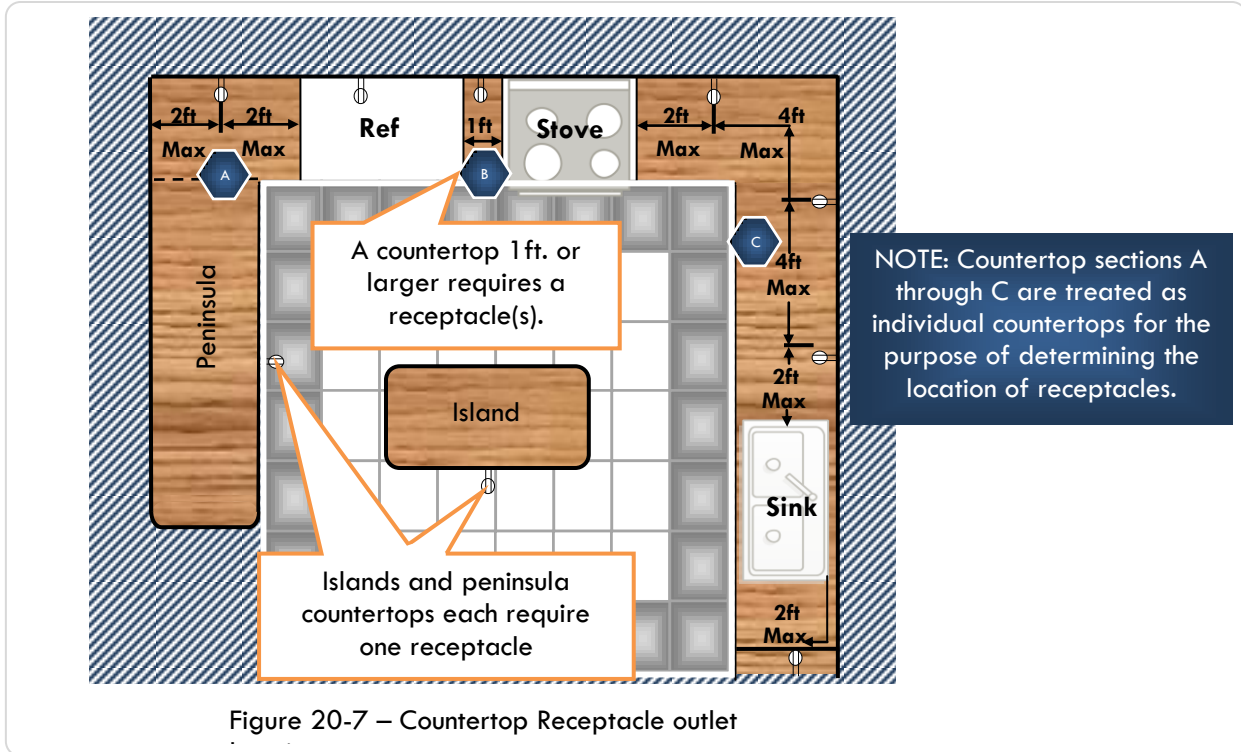

**Exception:** A receptacle is not required on a wall directly behind a range, counter-mounted cooking unit, or sink, in accordance with Figure 24.8 below:-

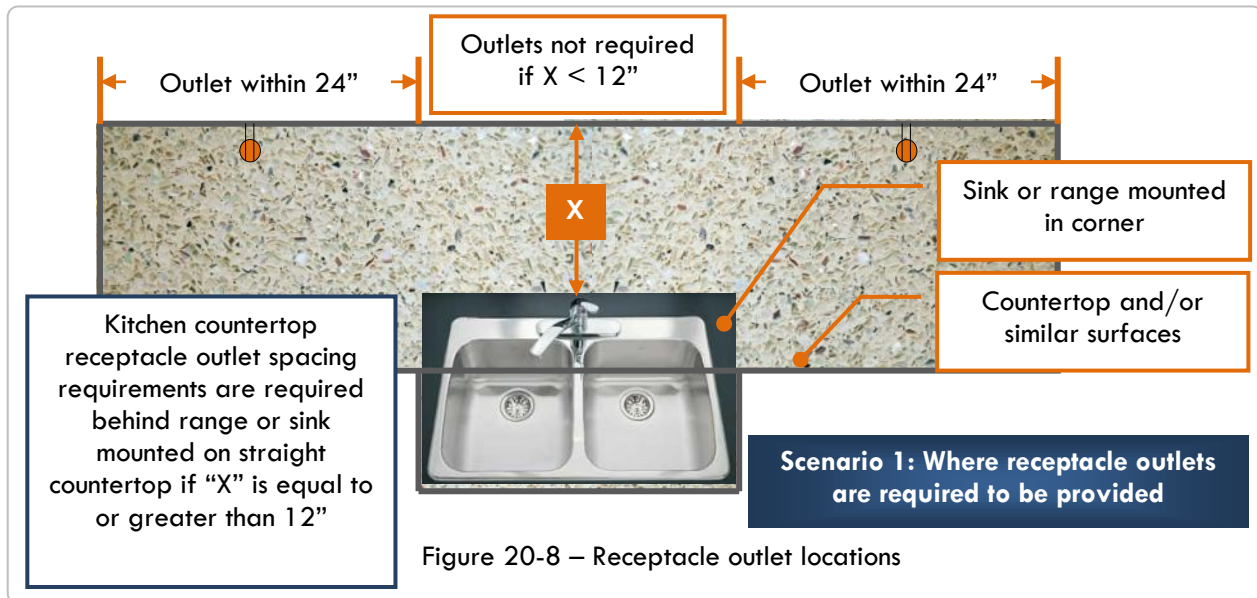

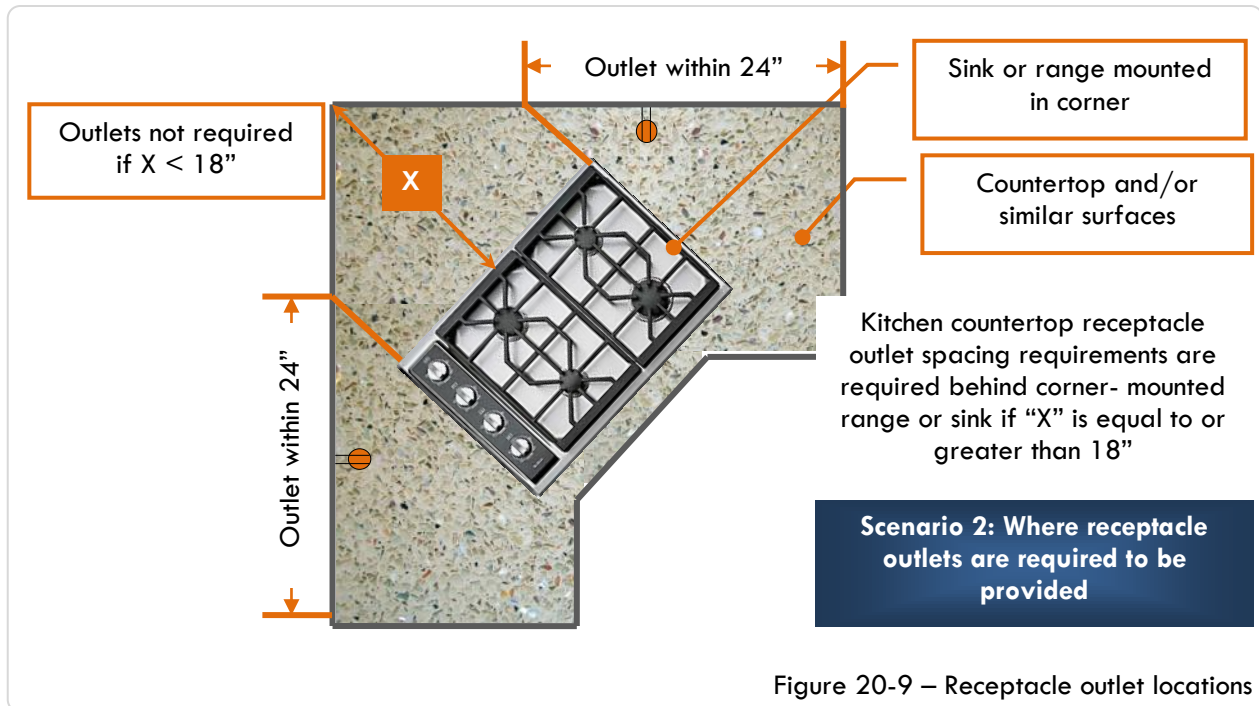

Figure 20-9 – Receptacle outlet locations

3. **Island counter spaces:** At least one receptacle outlet shall be installed at each island counter space with a long dimension of 24" or greater and short dimension of 12" or greater.
4. **Peninsular counter spaces:** At least one receptacle outlet shall be installed at each peninsular counter space with a long dimension of 24" or greater and a short dimension of 12" or greater. A peninsular counter space is measured from the connecting edge.

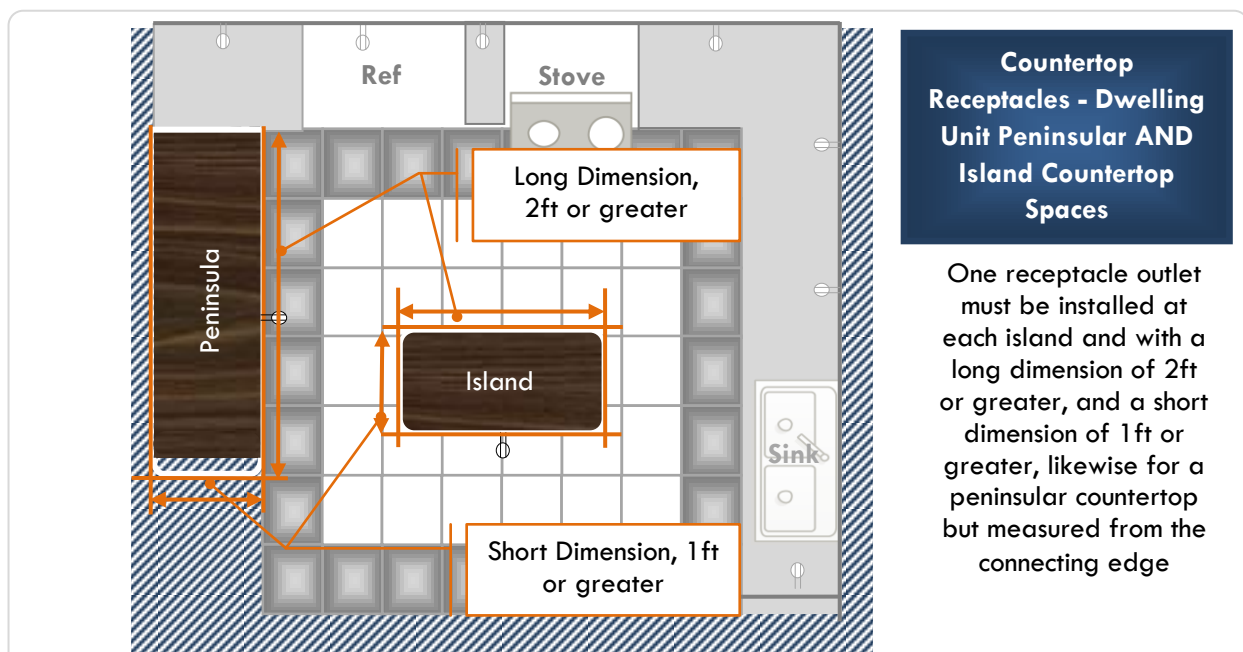

Figure 20-10 - Receptacle outlet locations



## Island / Peninsular Countertop Receptacle

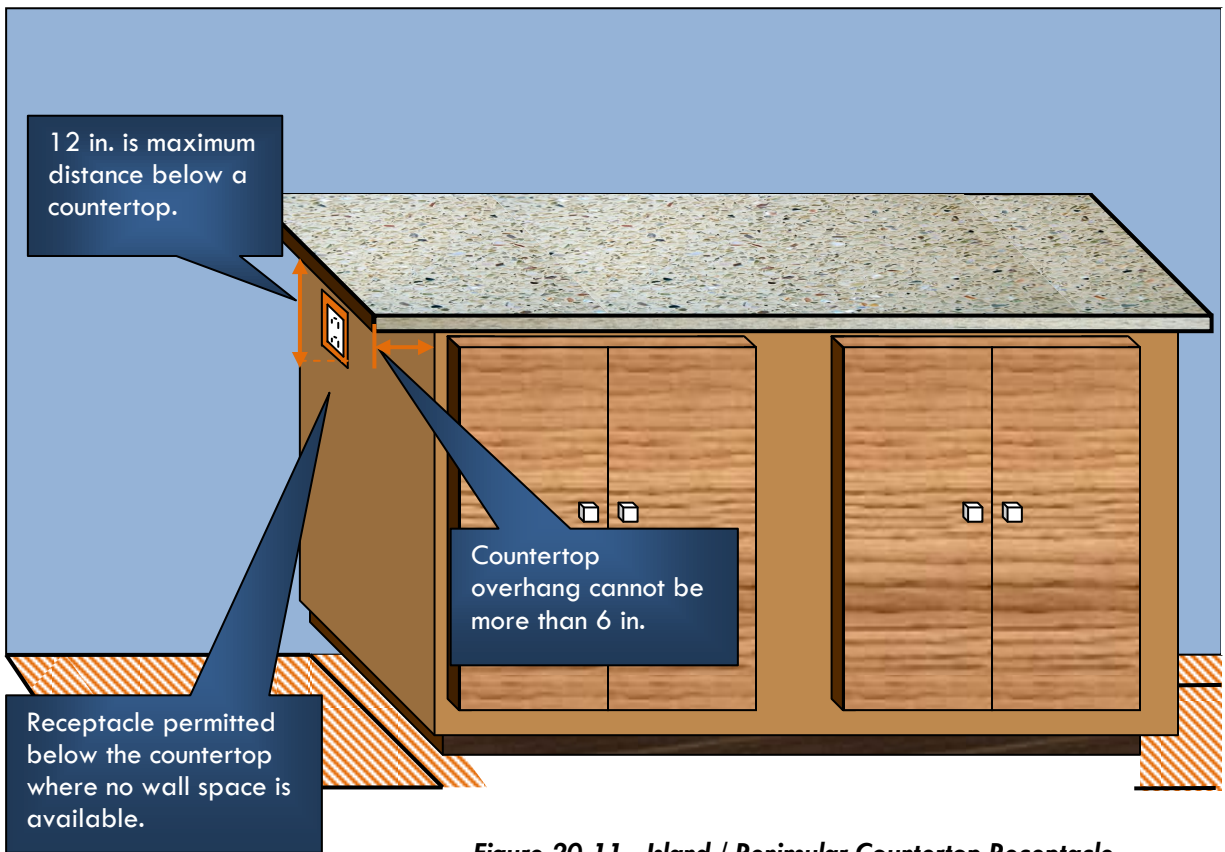

Figure 20-11 - Island / Peninsular Countertop Receptacle

5. **Separate spaces:** Countertop spaces separated by stoves, refrigerators or sinks shall be considered as separate countertop spaces.
6. **Receptacle outlet location:** Receptacle outlets shall be located not more than 18" above the countertop. Receptacle outlets that are not provided with ready access because of appliances fastened or appliances occupying dedicated space shall not be considered as these required outlets. Receptacle outlets shall not be installed in a face up position in work surfaces and countertops in a kitchen or dining area.

**20.9.7 BATHROOMS**

In *dwelling units*, at least one wall GFCI receptacle shall be installed adjacent to the basin (sink or lavatory) location. *Bathroom* receptacle outlets shall be supplied by at least one 20-ampere branch circuit. Such circuits shall have no other outlets. All receptacles in *bathrooms* shall be GFCI protected. A receptacle shall not be installed within a bathtub, hydromassage or shower space.

**20.9.8 APPLIANCE OUTLETS**

Appliance receptacle outlets installed for specific appliances such as laundry equipment shall be installed within 6 feet of the intended location of the appliance. At least one receptacle outlet shall be installed to serve laundry appliances.

### 20.9.9 BASEMENTS & GARAGES

At least one receptacle outlet, in addition to any provided for laundry equipment, shall be installed in each basement and each garage. All receptacles in garages shall be GFCI protected with the exception of a receptacle located within dedicated space for each appliance that is not easily moved from one place to another, and that is cord and plug connected.

- 1) **APPLIANCES IN GARAGES:** Electrical appliances capable of generating a spark, such as water pumps, shall be installed on a platform a minimum of 18" above the floor level of the garage. Alternatively, where such appliances are enclosed in separate compartments having access only from the outside of the garage, they may be installed at floor level.

### 20.9.10 HALLWAYS

Hallways of 10 feet or more in length shall have at least one receptacle outlet.

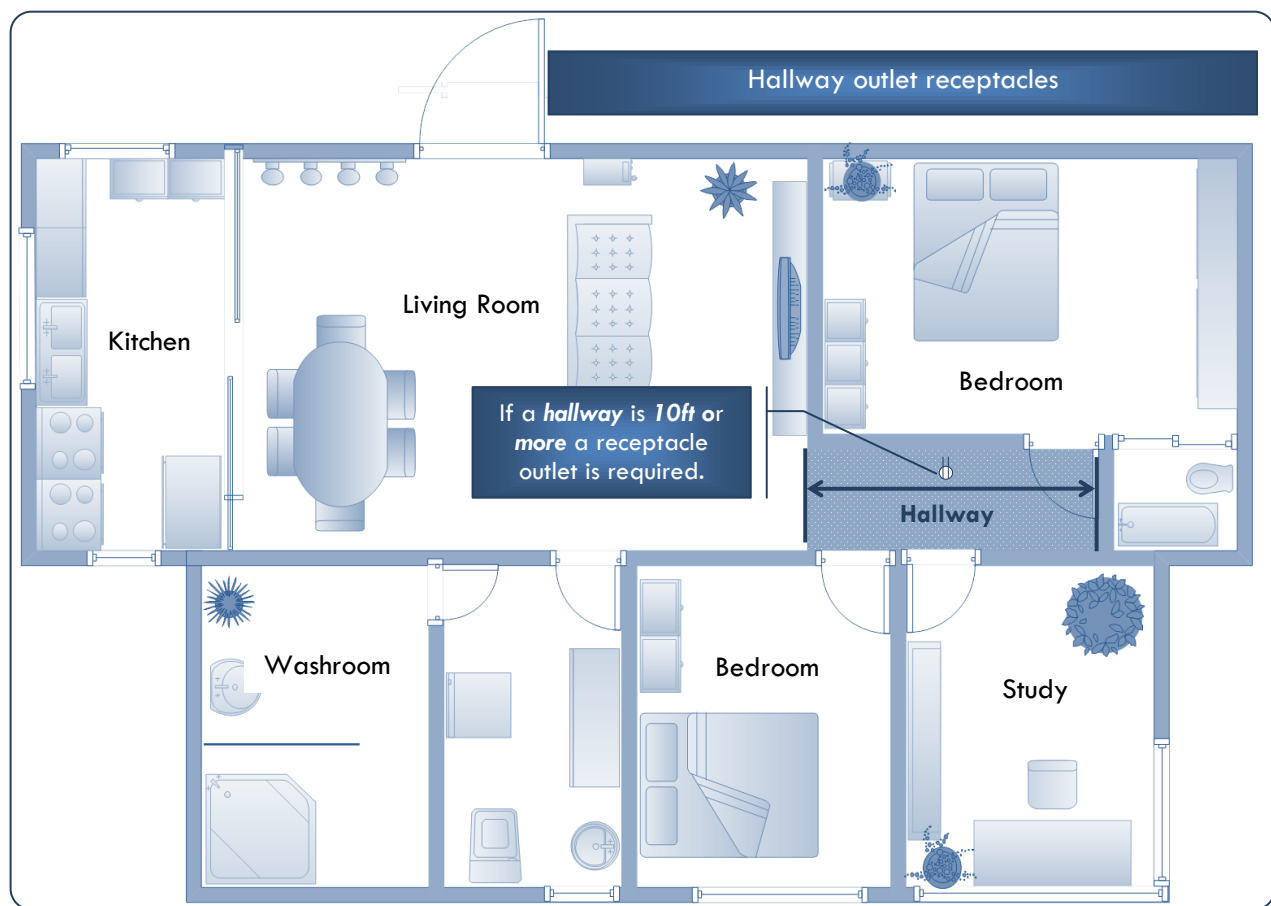
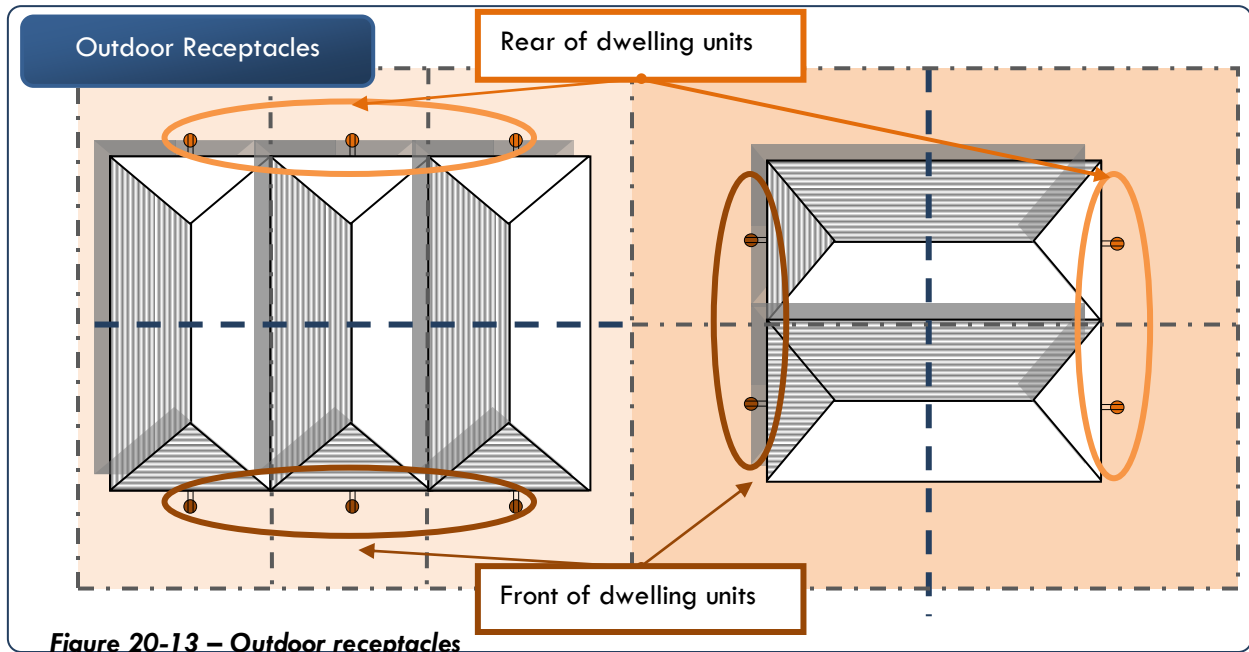

Figure 20-12 – Hallway receptacles

**20.9.11 OUTDOOR OUTLETS**

At least one receptacle outlet, accessible at grade, shall be installed outdoors at the rear and front of each *dwelling unit*. The outlet shall be installed not higher than 6'-6" above grade.



All outdoor receptacles shall have weatherproof cover plates and shall be GFCI protected.

**20.10 SUMMARY OF RECEPTACLE OUTLET LOCATIONS**

Description	Maximum Spacing (feet)	Minimum number of receptacles	Location	Note
Habitable Rooms	12		Within 6 ft. of a door and within 6 ft of any point along a wall	For wall space > 24 in. wide; wall receptacles < 5 ft. - 6in. above the floor; floor receptacles < 18 in. from wall.
Kitchen wall Counters	4		Within 2 ft. of any point along the wall line and < 20 in. above a counter	For wall counter > 12 in. wide
Kitchen Island or peninsular counter		1	< 20 in. above a counter	For counter > 12 in. X 24 in.
Hallway		1		For hallways > 10ft
Bathroom		1	< 36 in. from basin	Measured from outside edge of each basin.
Outdoors		1 at front and 1 at back	< 6ft – 6 in. above grade	Where there is access to grade.
Deck, Balcony, or porch		1	< 6ft – 6 in. above floor	Applies to all decks, balconies, or porches > 20 square feet and accessible from inside dwelling
Laundry Areas		1	< 6 in. from appliance	-
Basement		1	-	For basement with finished habitable space, one outlet for each separate unfinished area
Garage		1	-	-
HVAC Equipment		1	< 25 ft. from equipment	-

\* Note: > or < means equal to AND more or less than

Table 20.1 - Summary of Receptacle Outlet locations

**20.11 ELECTRIC WATER HEATERS**

Water heaters are required to have a timer with disconnect switch or a timer with two-pole toggle switch rated for the ampere of the heater. If the heater is within sight of the circuit breaker panel, the circuit breaker can be the means of disconnect

FPN- water heaters shall not have a cord and plug electrical connection, nor should flexible cable.

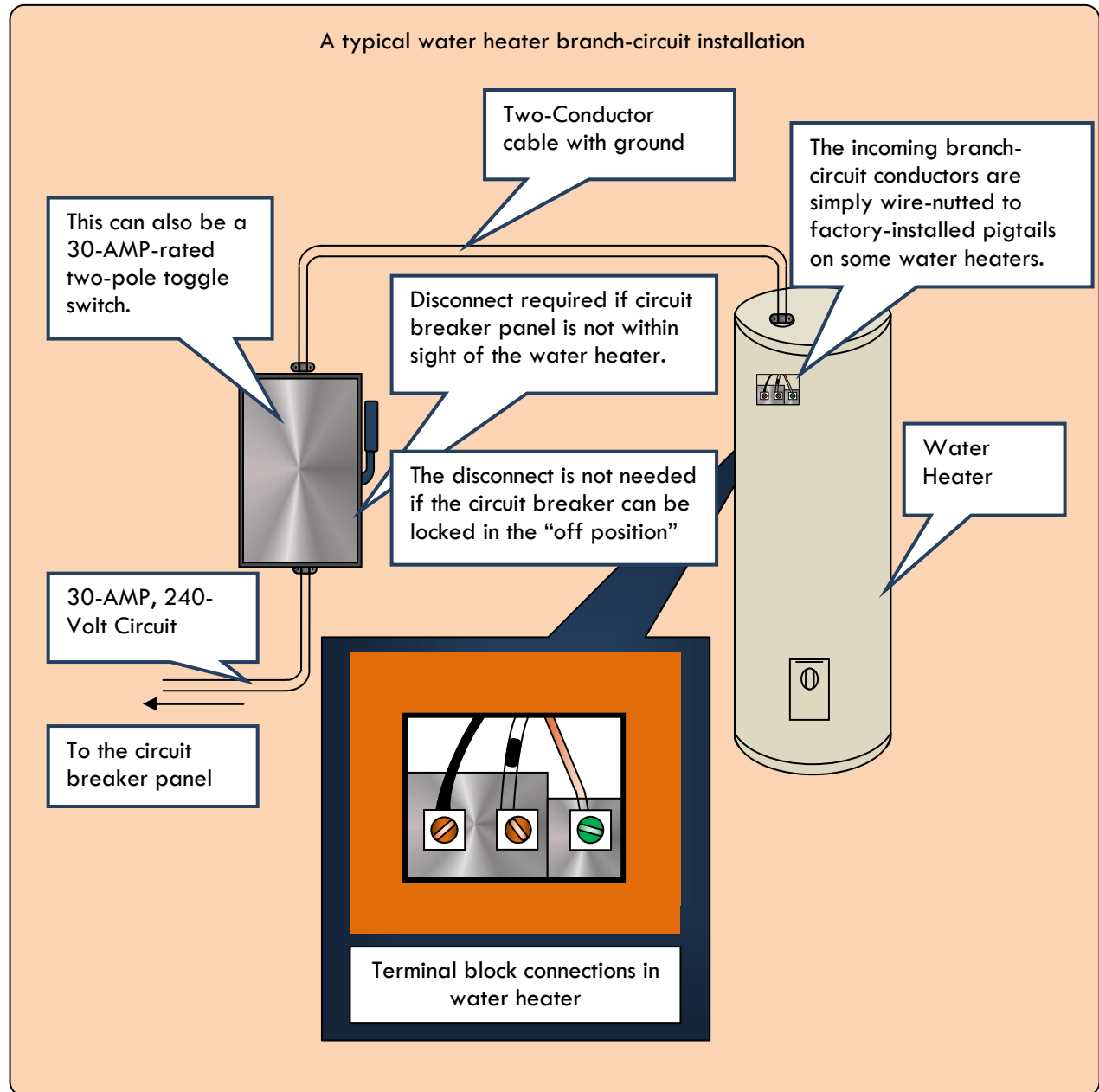

Figure 20-14 - A typical water heater branch-circuit installation

## 20.12 LIGHTING OUTLETS

### 20.12.1 **GENERAL**

At least one lighting outlet controlled by a wall switch shall be installed in every *habitable* and *ancillary room* and in *bathrooms*, hallways, stairways, garages and exterior egress doors.

**Exception:** In *habitable* rooms other than kitchens and bathrooms, one or more receptacles controlled by a wall switch shall be considered equivalent to the required lighting outlet.

### 20.12.2 **STAIRWAY LIGHTING CONTROL**

Where the difference between floor levels requires 6 or more stair risers, lighting outlets installed in the stairway shall be controlled by a wall switch at each floor level.

### 20.12.3 **ROOMS OR SPACES FOR STORAGE OR EQUIPMENT**

At least one lighting outlet shall be provided in attics, under-floor spaces, utility rooms and basements where such spaces are used for storage or contain equipment requiring servicing. The control for such lighting outlets shall be located at the point of entry to such spaces. Where equipment requiring servicing is present, the lighting outlet shall be provided at or near such equipment.

## 20.13 ARC- FAULT CIRCUIT- INTERRUPTER PROTECTION

Combination- type AFCI- protective devices are required in all dwelling unit rooms, except for kitchen, bathrooms, garages, basements, and rooms or areas not specified in this section.

## 20.14 GFCI RECEPTACLES

GFCI protected receptacles are required in the following locations:

- a) **Bathrooms:** All 120 volt receptacles, including those incorporated in a light fixture. (A bathroom is an area containing a basin with one or more of the following - a toilet, a tub or a shower).
- b) **Garages:** All 120 volt receptacles.

**Exception:** A receptacle located within dedicated space for each appliance that is not easily moved from one place to another, and that is cord and plug connected.

- c) **Kitchen:** All receptacles to serve countertop surfaces (Figure 21.16).

**Exception: Wetbar or Bar Sink Receptacles:** GFCI receptacles to serve countertops **BEYOND** 6 feet of a sink are not required to be GFCI protected (Figure 21.17).

- d) **Outdoor Receptacles:** All receptacles
- e) **Boathouse:** All receptacles
- f) **Pool house:** All receptacles

- g) Swimming Pools:** All receptacles within 20' of the inside wall of the pool. Note: At least one outside GFCI receptacle must be provided within 20' of the inside wall of the pool, but not closer than 10' to the inside wall.
- h) Hydromassage bathtubs:** Hydromassage bathtubs and their associated electrical components shall be GFCI protected and must be on a dedicated circuit and readily accessible or have a GFCI 'circuit breaker'. GFCI protection is required for all 125-volt, single phase, 15-20-, and 30-ampere rated receptacles within 6ft of the hydromassage bathtub.

#### Receptacles in Damp or Wet locations or Shower Space

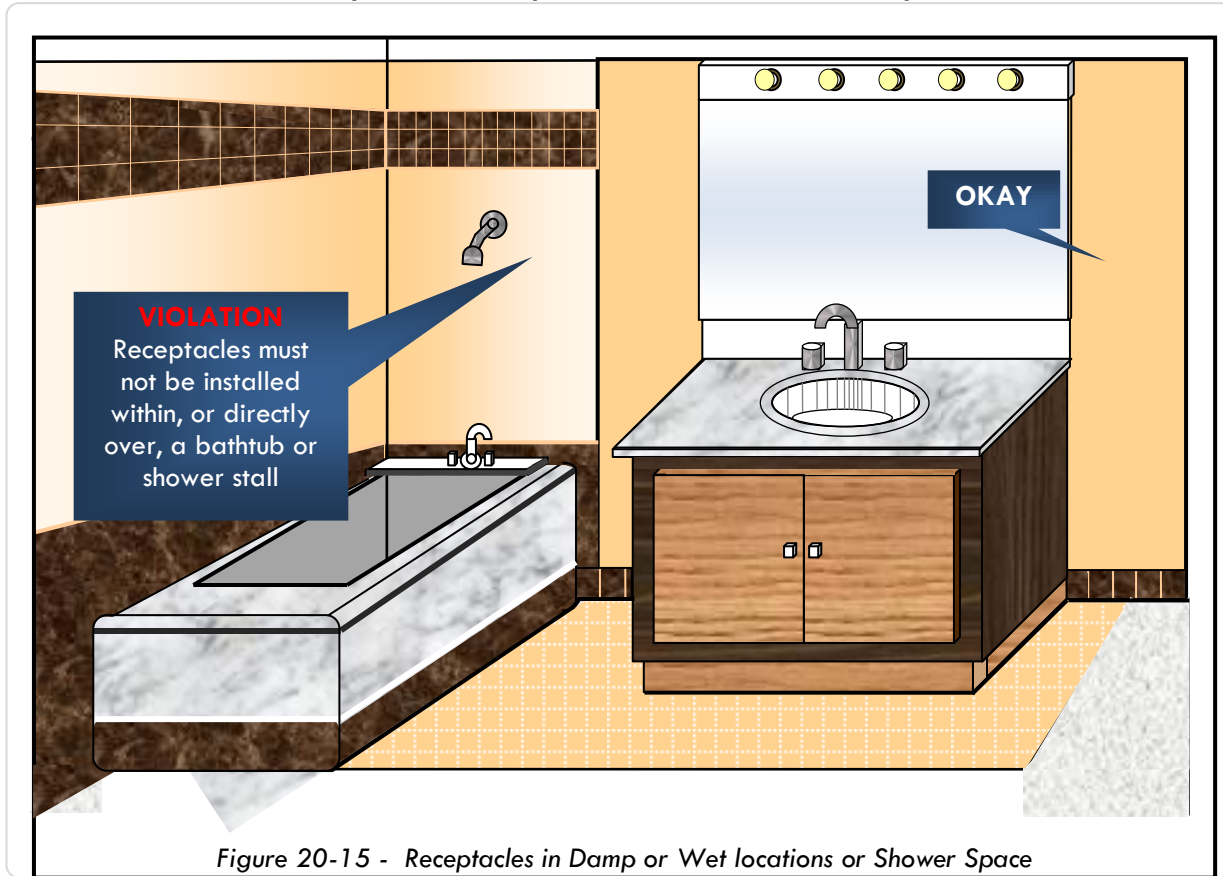

Figure 20-15 - Receptacles in Damp or Wet locations or Shower Space

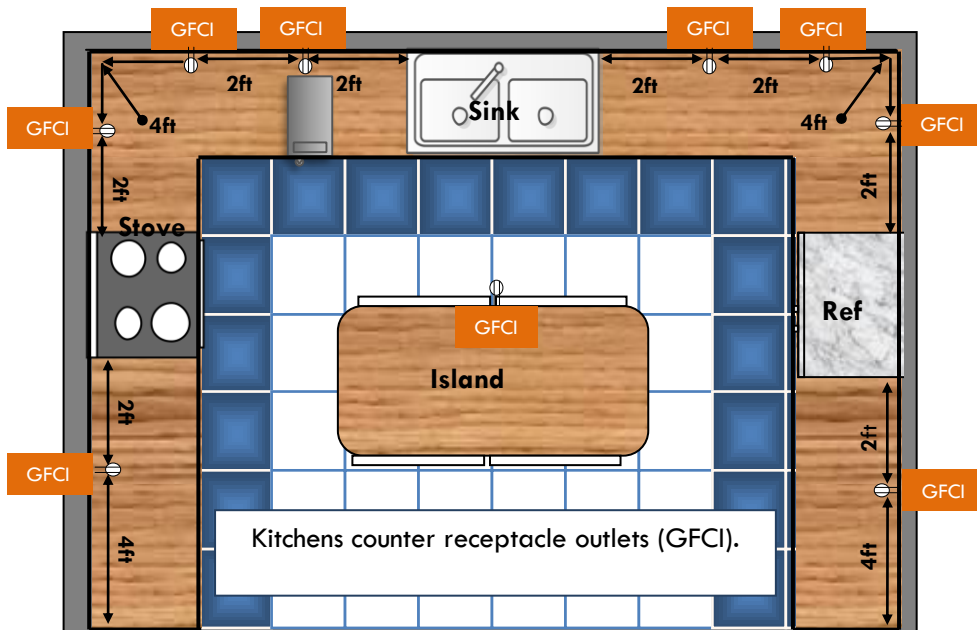

Figure 20-16 - Kitchen GFCI receptacles outlets locations

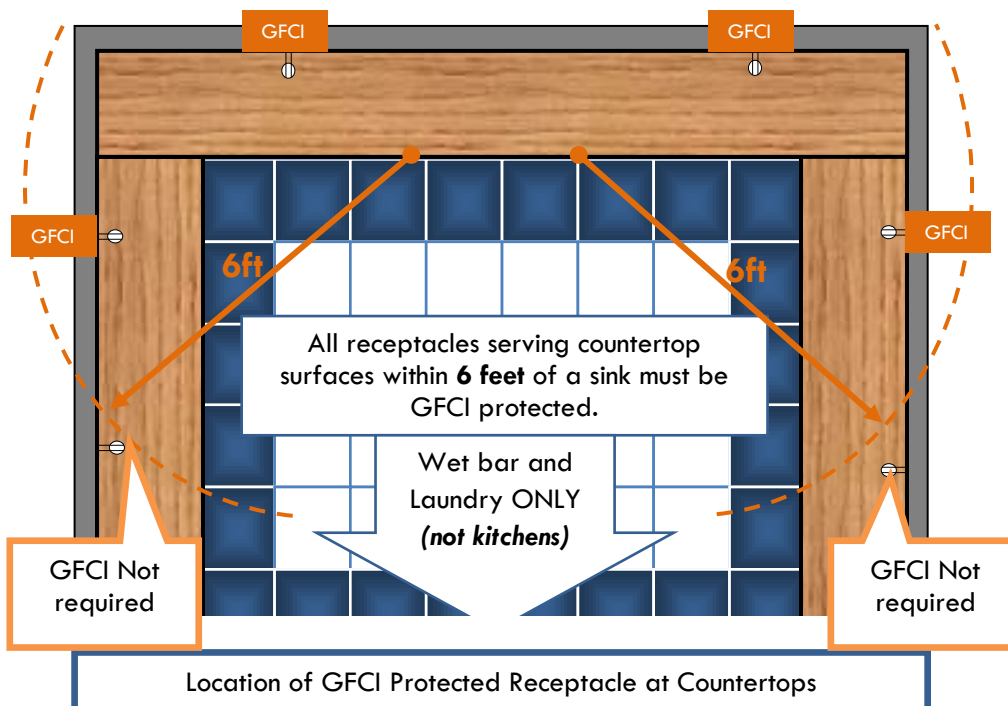
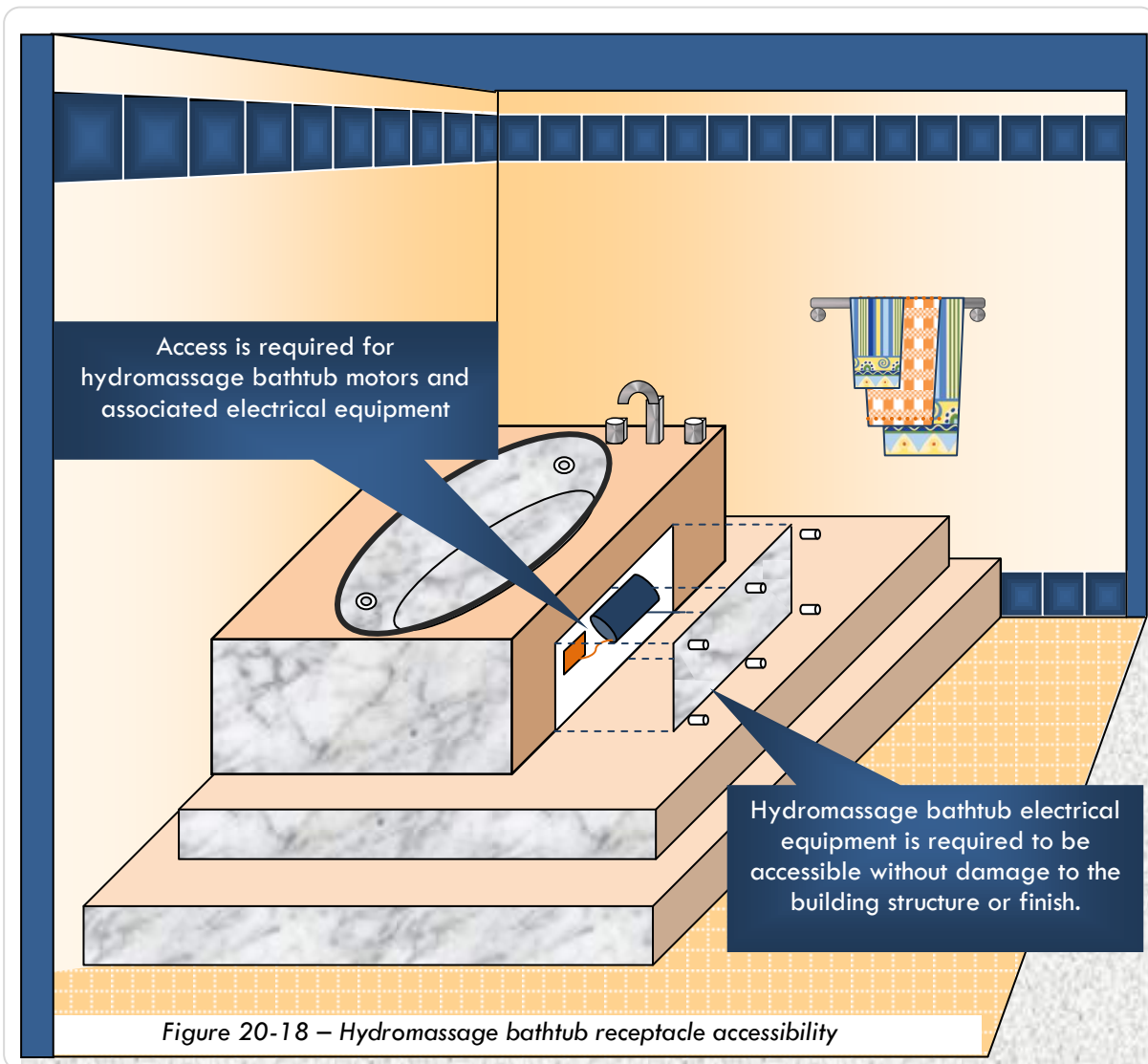

Figure 20-17 - Wet bar, bar sink, laundry area - GFCI receptacle outlet locations





## 20.15 FIXTURE LOCATIONS

### 20.15.1 WET AND DAMP LOCATIONS

Fixtures installed in wet or damp locations shall be installed so that water cannot enter or accumulate in wiring compartments, lamp holders, or other electrical parts. All fixtures installed in wet locations shall be listed "Suitable for Wet Locations". All fixtures installed in damp locations shall be listed "Suitable for Damp Locations".

Installations underground or in concrete slab or masonry in direct contact with the earth, and locations subject to saturation with water or other liquids, such as locations exposed to the weather and unprotected shall be considered wet locations.

Interior locations protected from the weather but subject to moderate degrees of moisture, such as unfinished basements, partially protected locations under canopies, marquees, roofed open porches and the like shall be considered damp locations.

The zone measuring 8'-0" above the top of the bathtub, shower or hydromassage tub shall be considered a wet location. The zone measured 3 feet horizontally from the edge of the bathtub or hydromassage tub rim or the shower enclosure to the ceiling above shall be considered a damp location.

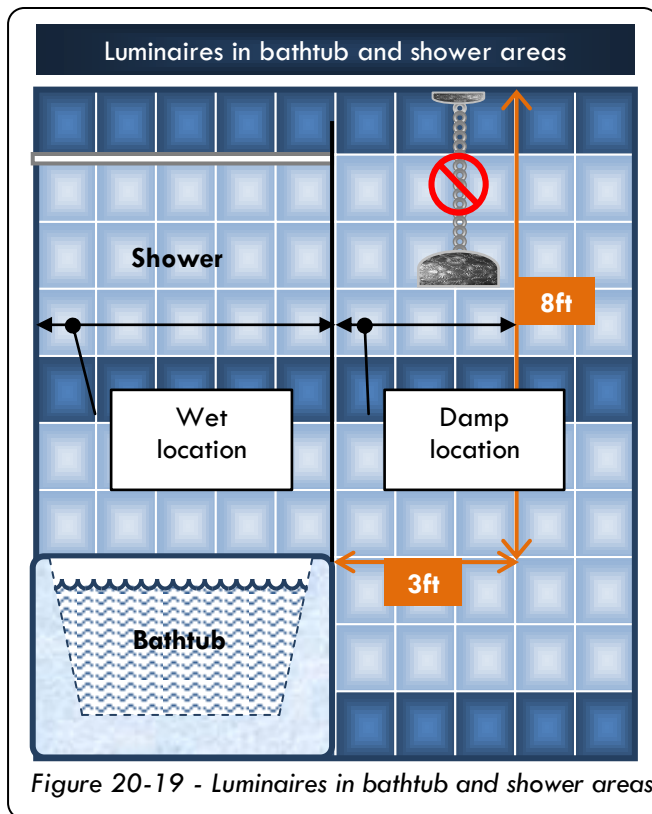

Figure 20-19 - Luminaires in bathtub and shower areas

### 20.15.2 ABOVE BATHTUBS, HYDROMASSAGE TUBS AND SHOWERS

No parts of cord-connected fixtures, hanging fixtures, lighting track, pendants, or ceiling fans shall be located within a zone measured 3' horizontally and 8' vertically from the top of the bathtub rim. This zone is all encompassing and includes the zone directly over the "bathtub, hydro-massage tub or shower". All fixtures in the zone classified as damp per section 21.15.1 shall be marked "suitable for damp locations" and all fixtures in the zone classified as wet per section 21.15.1 shall be marked "suitable for wet locations". In addition, all fixtures in damp or wet locations shall be GFCI protected and installed in accordance to the manufacturer's specifications.

In addition to the requirements stated above, the **Heat/Vent lights** in the bathroom must be on a dedicated 20amp circuit.

## 20.16 LUMINAIRES IN CLOTHES CLOSETS

### 20.16.1 LUMINAIRE TYPES PERMITTED

Listed luminaires of the following types shall be permitted to be installed in a closet:

- 1) Surface mounted or recessed incandescent luminaires with a completely enclosed lamp;
- 2) Surface mounted or recessed fluorescent luminaires; or,
- 3) Surface mounted or recessed LED luminaires identified as suitable for installation within a storage area.

### 20.16.2 INCANDESCENT LUMINAIRE TYPES NOT PERMITTED

Incandescent luminaires with open or partially enclosed lamps and pendant luminaires or lamp-holders shall not be permitted.

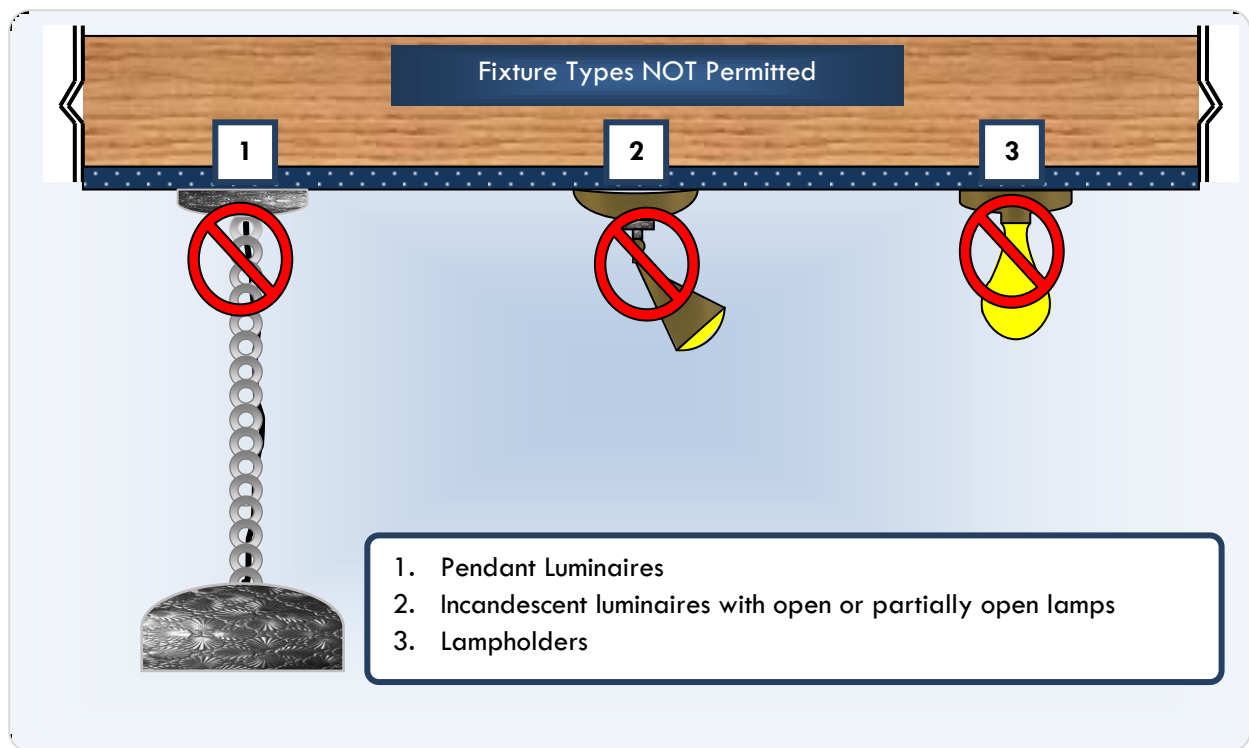
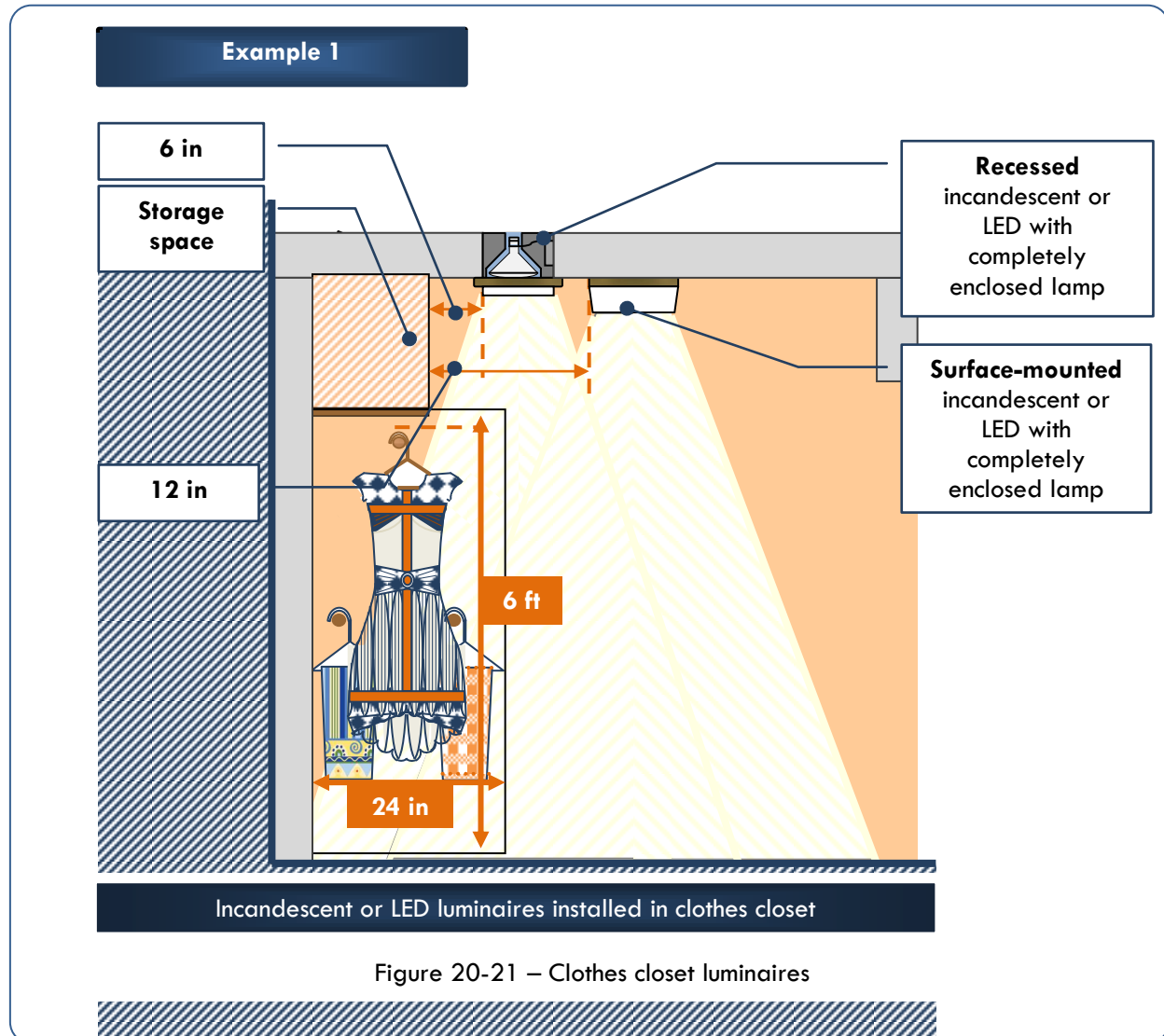

Figure 20-20 – Fixtures not permitted

### 20.16.3 LOCATION

The minimum clearance between luminaires installed in clothes closets and the nearest point of a storage space shall be as follows:

1. 12" for surface-mounted incandescent or LED luminaires with a completely enclosed light source installed on the wall above the door or on the ceiling (Figure 1.19);
2. 6" for recessed incandescent or LED luminaires with a completely enclosed light source installed in the wall or the ceiling (Figure 21.21);



3. 6" for surface mounted incandescent luminaires installed on the wall above the door or on the ceiling (Figure 21.22);
4. 6" for recessed incandescent luminaires installed in the wall or the ceiling (Figure 21.22);
5. Surface-mounted fluorescent or LED luminaires shall be permitted to be installed within the storage space where identified for this use (Figure 21.22).

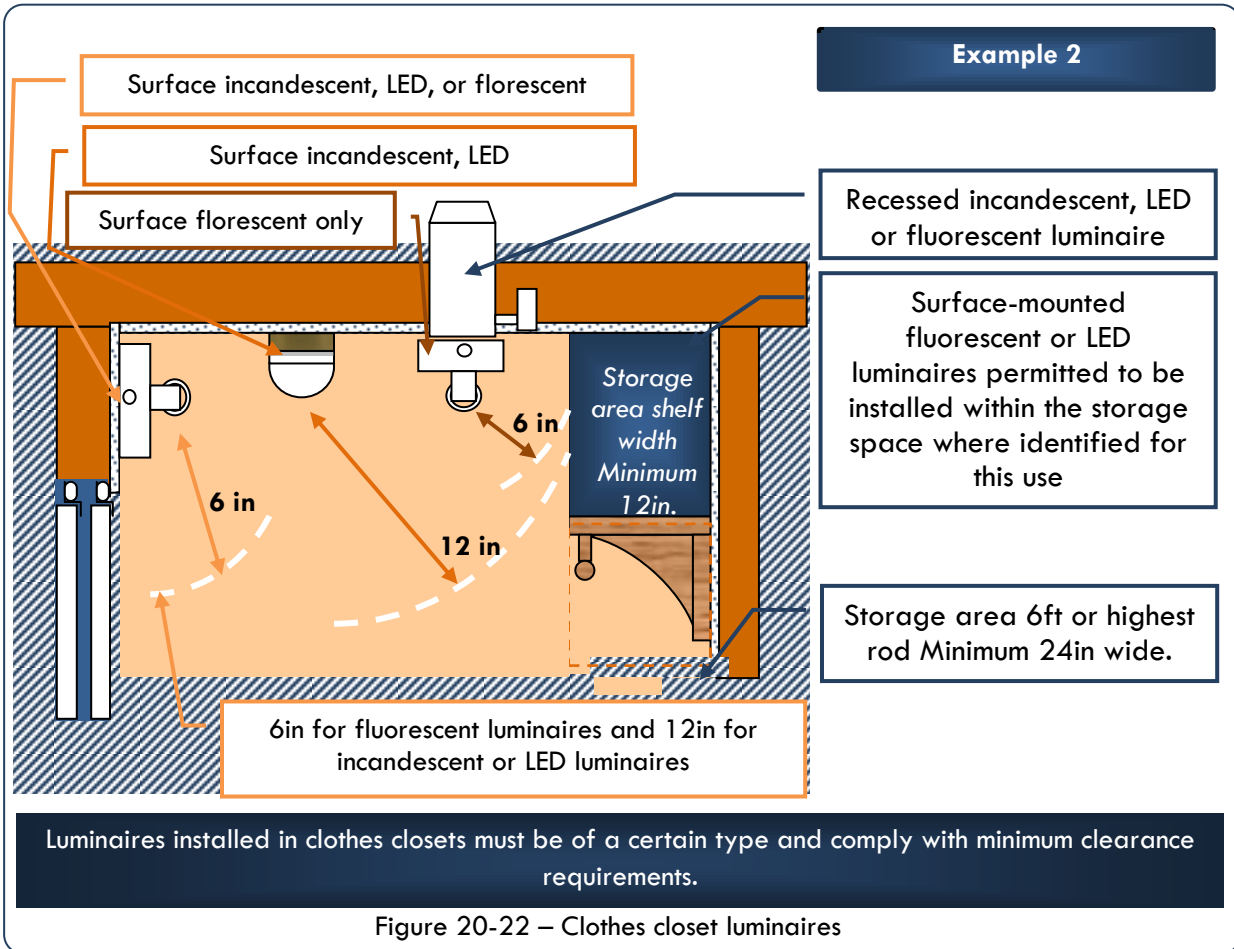

## 20.17 SWITCHES

### 20.17.1 WET LOCATIONS

A switch or circuit breaker in a damp or wet location shall be enclosed in a weatherproof enclosure or cabinet. A flush-mounted switch or circuit breaker in a wet or damp location shall be equipped with a weatherproof cover. Switches shall not be installed within wet locations in the tub or shower spaces unless installed as part of a listed tub or shower assembly.

## 20.18 PANELBOARDS AND CIRCUIT BREAKERS

### 20.18.1 RATING

All panelboards shall have a rating not less than the minimum service entrance or feeder capacity required for the calculated load. Panelboards shall be durably marked by the manufacturer with the voltage, the current rating, the number of phases for which they are designed and the manufacturer's name or trademark in such a manner so as to be visible after installation without disturbing the interior parts or wiring.

**20.18.2 OVERCURRENT PROTECTION**

A panelboard shall be protected by an overcurrent protective device having a rating not greater than that of the panelboard. This overcurrent protective device shall be located within or at any point on the supply side of the panelboard.

**20.18.3 NUMBER OF OVERCURRENT PROTECTION DEVICES**

A panelboard shall be provided with physical means to prevent the installation of more overcurrent devices than that number for which the panel board was designed, rated and listed. This applies to tandem (or piggy bank circuit breakers) aside from the second exception to 408.36 the maximum of 42 over current devices was deleted for the 2008 code. Now the quantity of over current devices is limited to design and listing of the panel board.

**20.18.4 DEDICATED SPACE**

The space equal to the width and depth of the panelboard and extending from the floor to the structural ceiling shall be dedicated to the electrical installation. No piping, ducts or equipment foreign to the electrical installation shall be located in this space. A dropped or suspended ceiling is not a structural ceiling for the purposes of the section.

**20.18.5 WORKING CLEARANCES**

The clear working space in front of a panel board shall be not less than 30" in width measured from one side of the panel board, 36" in depth measured from the face of the panel board, and 6'-6" in height measured from the floor. In all cases, the work space shall permit at least a 90 degree opening of equipment doors. The working space shall not be used for storage. The clear space area in front of the panel board shall be level or on a slope not exceeding 1 in 12 in any direction. The bottom of the panel board shall be a minimum of 3 feet above floor level.

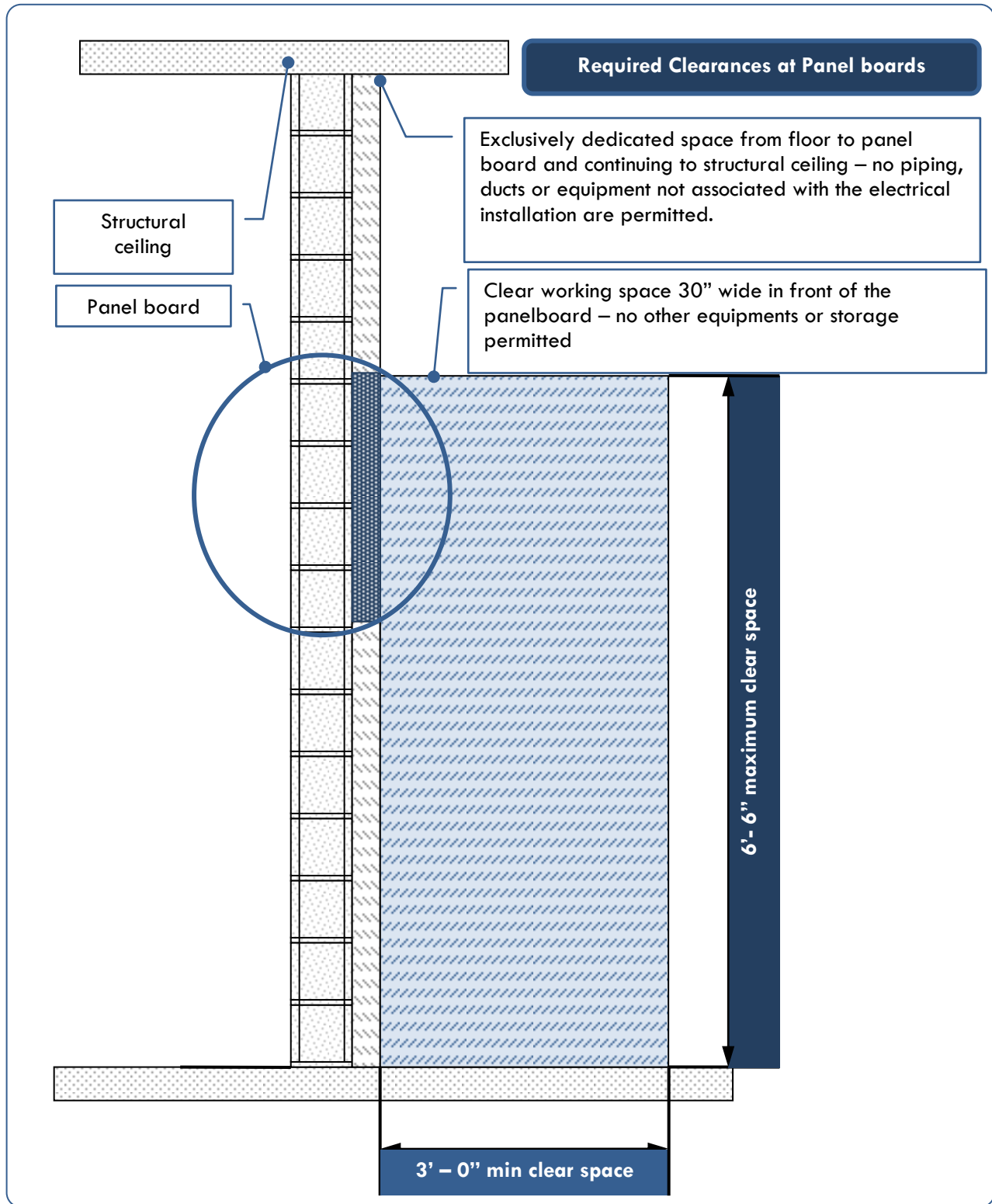

Figure 20-23 – Required Clearances of Panel Boards

**20.18.6 LIGHTING**

Where the panelboard is situated in an enclosed space the work space shall be equipped with an artificial light.

**20.18.7 PROHIBITED LOCATIONS**

The panelboard and overcurrent protection shall not be located in bathrooms, toilet rooms, clothes closets, pump rooms or stairways.

**Exception:** Panelboards may be installed in pump rooms if an impermeable wall is used to enclose the electrical equipment and separate it from any water pump equipment and piping.

All overcurrent protection by means of circuit breakers and/or fuses installed in the panelboard shall be readily accessible to the occupant.

**20.18.8 CIRCUIT IDENTIFICATION**

The use or purpose of all panelboard circuits shall be legibly marked and identified on a circuit directory mounted on the face or inside the door of the enclosure.

**20.18.9 CONTINUOUS LOAD**

The total load on any overcurrent device located in a panel board shall not exceed 80 percent of its rating where, in normal operation, the load will continue for three hours or more.

**20.18.10 MULTI WIRE BRANCH CIRCUITS****20.18.10.1 GENERAL**

All conductors of a multi wire branch circuit shall originate from the same panelboard or similar distribution equipment.

**20.18.10.2 DISCONNECTING MEANS**

Each multi wire branch circuit shall be provided with a means that will simultaneously disconnect all ungrounded conductors at the point where the branch circuit originates.

Ungrounded and grounded (neutral) conductors of each multi wire branch circuit shall be grouped in at least one location within a panelboard or other enclosure.

FPN- Multi wire branch circuits must be grouped together with their associated grounded neutral conductor at the branch circuit panelboard unless the grouping is obvious.



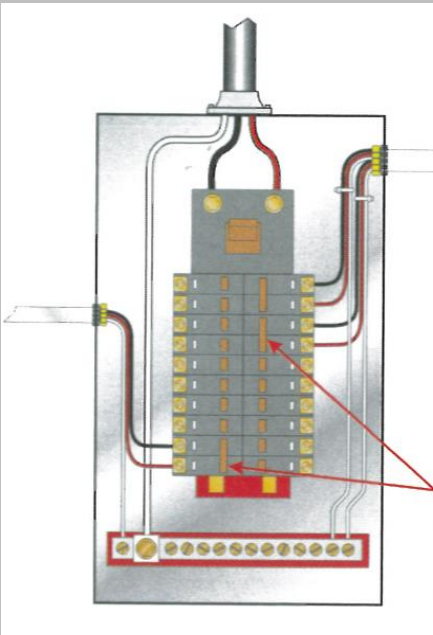

### Multiwire Branch Circuits (NEC 210.4)

b) General. All conductors of a multiwire branch circuit shall originate from the same panelboard or similar distribution equipment.

a) Disconnecting means. Each multiwire branch circuit shall be provided with a means that will simultaneously disconnect all ungrounded conductors at the point where the branch circuit originates

Figure 20-24- Multiwire Branch Circuits

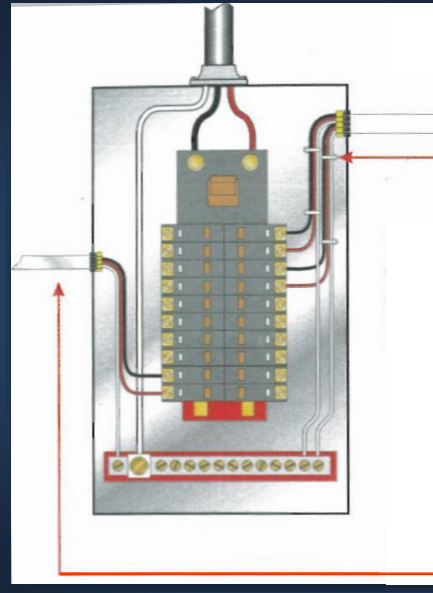

### Grouping (NEC 210.4 (D))

**Multiwire branch circuits**

Ungrounded and grounded conductors of each multiwire branch circuit shall be grouped in at least one location within a panelboard or other enclosure.

Grouping is not required if the circuit enters from a raceway or cable unique to the circuit, making the grouping obvious.

Figure 20-25- Grouping

**20.18.11 ACCESSIBILITY**

All switches and circuit breakers used as switches shall be located so that they may be operated from a readily accessible place. They shall be installed such that the center of the grip of the operating handle of the switch or circuit breaker, when in its highest position, is not more than 6'-7" above the floor or working platform.

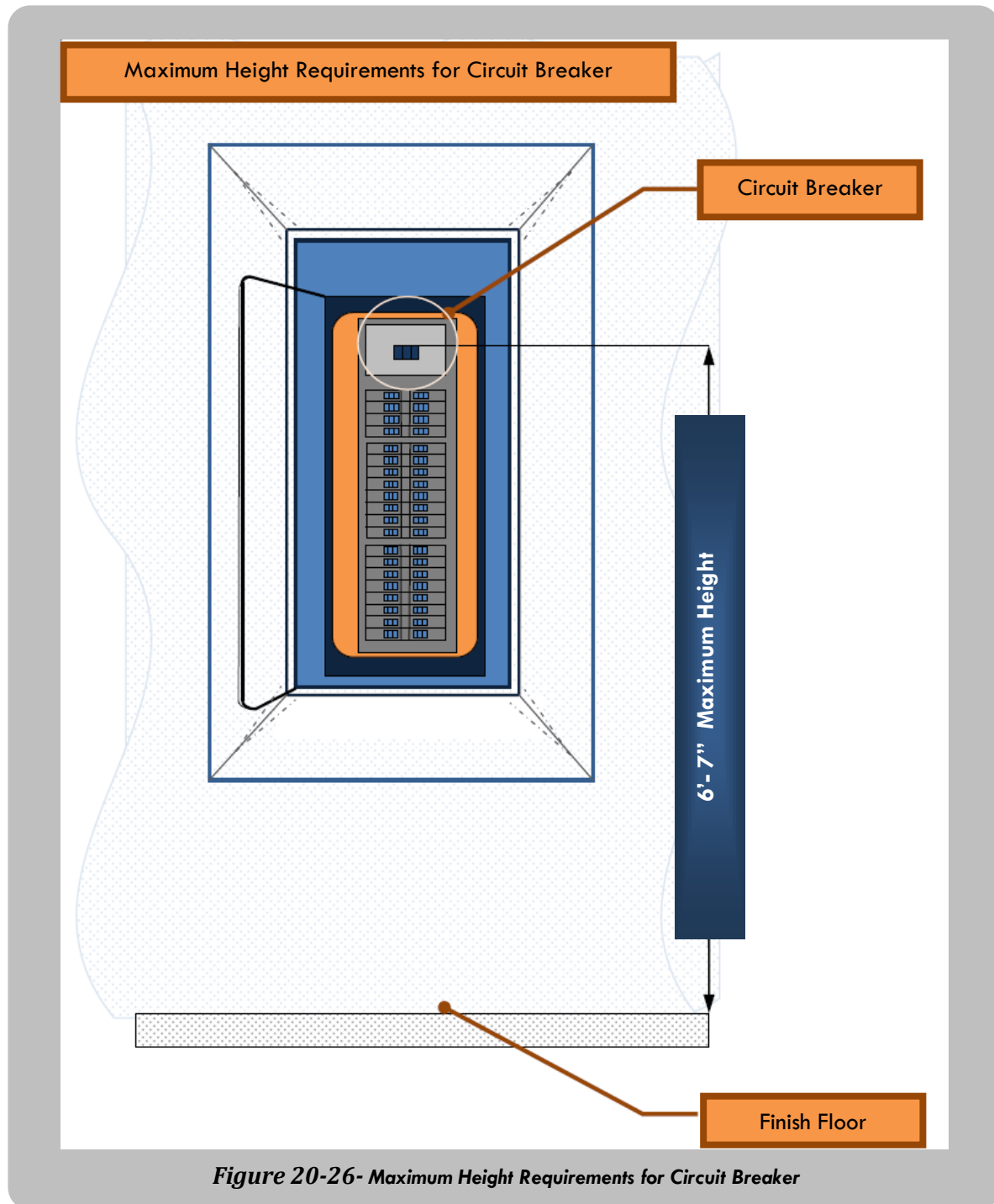

*Figure 20-26- Maximum Height Requirements for Circuit Breaker*

**20.19     OUTDOOR ELECTRICAL EQUIPMENT**

All electrical equipment installed outdoors shall be installed in weatherproof enclosures, shall be protected from accidental contact by unauthorized personnel or vehicular traffic and shall be protected from accidental spillage from piping systems.

**20.20     SEPARATE DWELLINGS**

Each separate *dwelling unit* shall have its own meter and panelboard installed complete with main circuit breaker. All circuits for separate dwellings shall be isolated from one another.

**20.21     APPLIANCES IN GARAGES**

Electrical appliances capable of generating a spark, such as water pumps, shall be installed on a platform a minimum of 18" above the floor level of the garage. Alternatively, where such appliances are enclosed in separate compartments having access only from the outside of the garage, they may be installed at floor level.

**20.22     SWIMMING POOLS**

Non self-contained, non listed pool designs shall be confirmed by Registered Engineers and drawings shall bear stamps of both a supervising Electrical and Mechanical Engineer. The designs shall comply with current BBC, IBC and NEC.

**20.22.1    RECEPTACLES**

At least one 120-volt GFCI receptacle shall be located between 6' and 20' from the inside wall of the pool. This receptacle shall be located not more than 6'-6" above the floor, platform or grade level serving the pool.

All receptacles within 20' of the inside wall of a pool shall be GFCI protected.

**20.22.2    POOL WATER PUMPS**

All swimming pool pumps must be GFCI protected. All outlets supplied by single phase 15- & 20-ampere, 125-volt or 240-volt branch circuits for swimming pool pump motors are required to have GFCI protection. It should be noted that NEC 680.22(b) applies to the outlets regardless of their proximity to the swimming pool and that it applies to cord and plug connected and direct connected (hard wired) swimming pool pumps.

As required by the NEC 680.22(a)(3), each permanently installed pool in a residential setting is required to have at least one receptacle, which must be located at least 6' from the pool and not more than 20' from the pool.

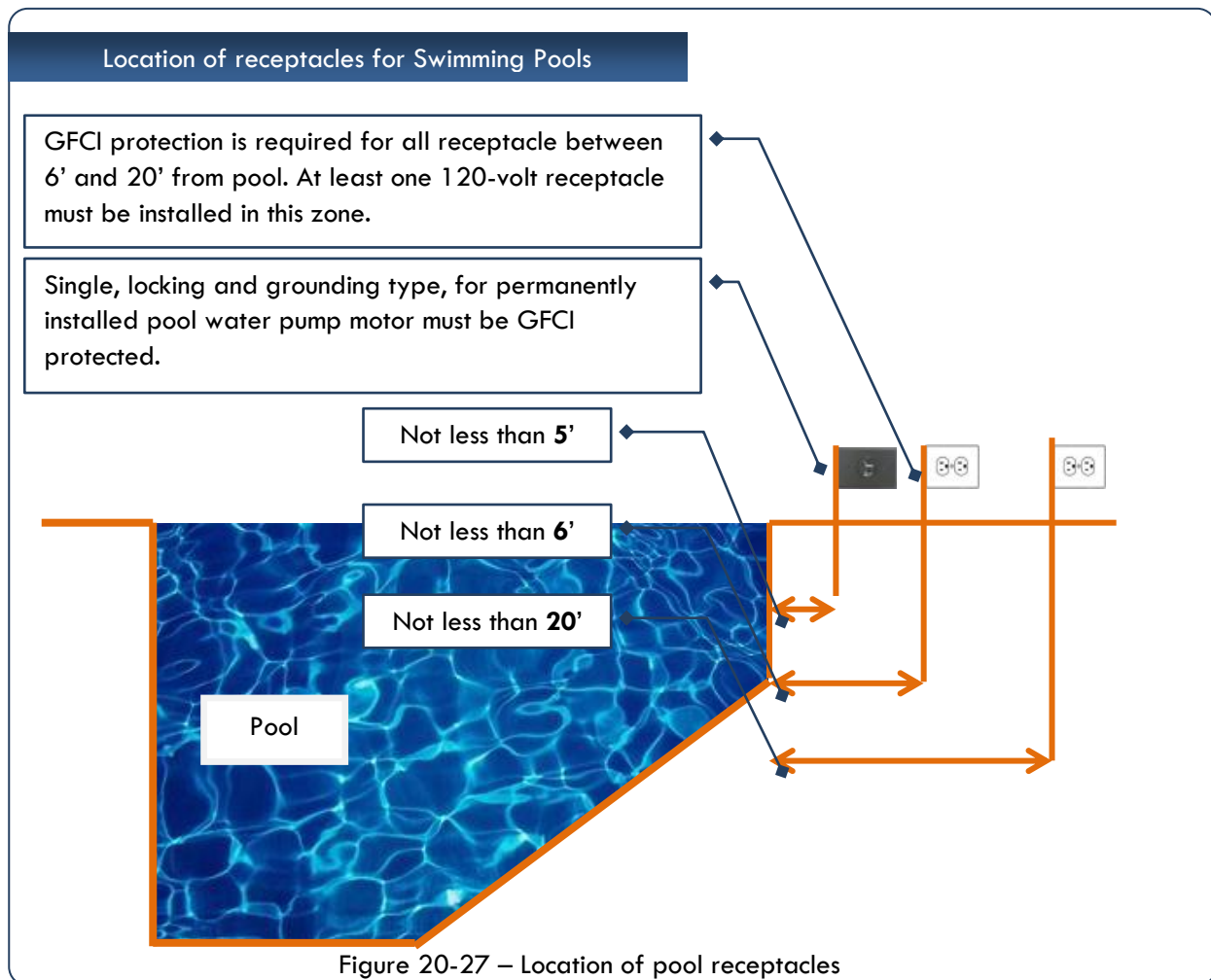

- \* **Note:** In determining the above dimensions, the distance to be measured is the shortest path the supply cord of an appliance connected to the receptacle would follow without piercing a floor, wall, ceiling, doorway with hinged or sliding door, window opening, or other effective barrier.

### 20.22.3 SWITCHING DEVICES

Switching devices on the property shall be located at least 5' horizontally from the inside walls of a pool unless separated from the pool by a solid wall, fence or other permanent barrier.

### 20.22.4 MAINTENANCE DISCONNECTING MEANS

One or more means to simultaneously disconnect all ungrounded conductors shall be provided for all utilisation equipment other than lighting. Each means shall be readily accessible and within sight from its equipment and shall be located at least 5' horizontally from the inside walls of a pool, spa, or hot tub unless separated from the open water by a permanently installed barrier that provides 5' reach path or greater. The horizontal distance is to be measured from the water's edge along the shortest path required to reach the disconnect.

**20.22.5 LIGHTING FIXTURES, LIGHTING OUTLETS AND CEILING FANS**

1. Lighting fixtures, lighting outlets and ceiling fans shall not be installed over the pool or over the area extending 5' horizontally from the inside walls of a pool unless no part of the lighting fixture or ceiling fan is less than 12' above the maximum water level.

**Exception No. 1:** Existing lighting fixtures and lighting outlets located less than 5' measured horizontally from the inside walls of a pool shall be at least 5' above the maximum water level and shall be rigidly attached to the existing structure and shall be GFCI protected.

**Exception No. 2:** In indoor pool areas, the limitations listed above shall not apply if all the following conditions are complied with:

- a) Fixtures are of totally enclosed type;
  - b) a GFCI protector is installed in the branch circuit supplying the fixtures or ceiling fans; and
  - c) the distance from the bottom of the fixture or ceiling fan to maximum water level is not less than 7'-6".
2. Lighting fixtures and lighting outlets installed in the area extending between 5' and 10' horizontally from the inside walls of a pool shall be GFCI protected, unless installed 5' above the maximum water level and rigidly attached to the structure adjacent to or enclosing the pool.
  3. Wet-Niche Luminaires.
    - a) Forming shells shall be installed for mounting of all wet-niche underwater luminaires and shall be equipped with provisions for conduit entries. Metal parts of the luminaire and forming shell in contact with the water shall be of brass or other approved corrosion-resistant metal.
  4. Junction boxes are required to be located not less than 4" above the ground level, or pool deck, and not less than 8" above the maximum pool water level, whichever provides the greatest elevation. The measurement is to be taken from the inside bottom of the junction box. The junction or deck box shall be located at least 4' from the inside wall of the pool. Less than 4' of separation is permitted where the deck or junction box is separated from the pool by a solid fence, wall or other permanent barrier.

5.

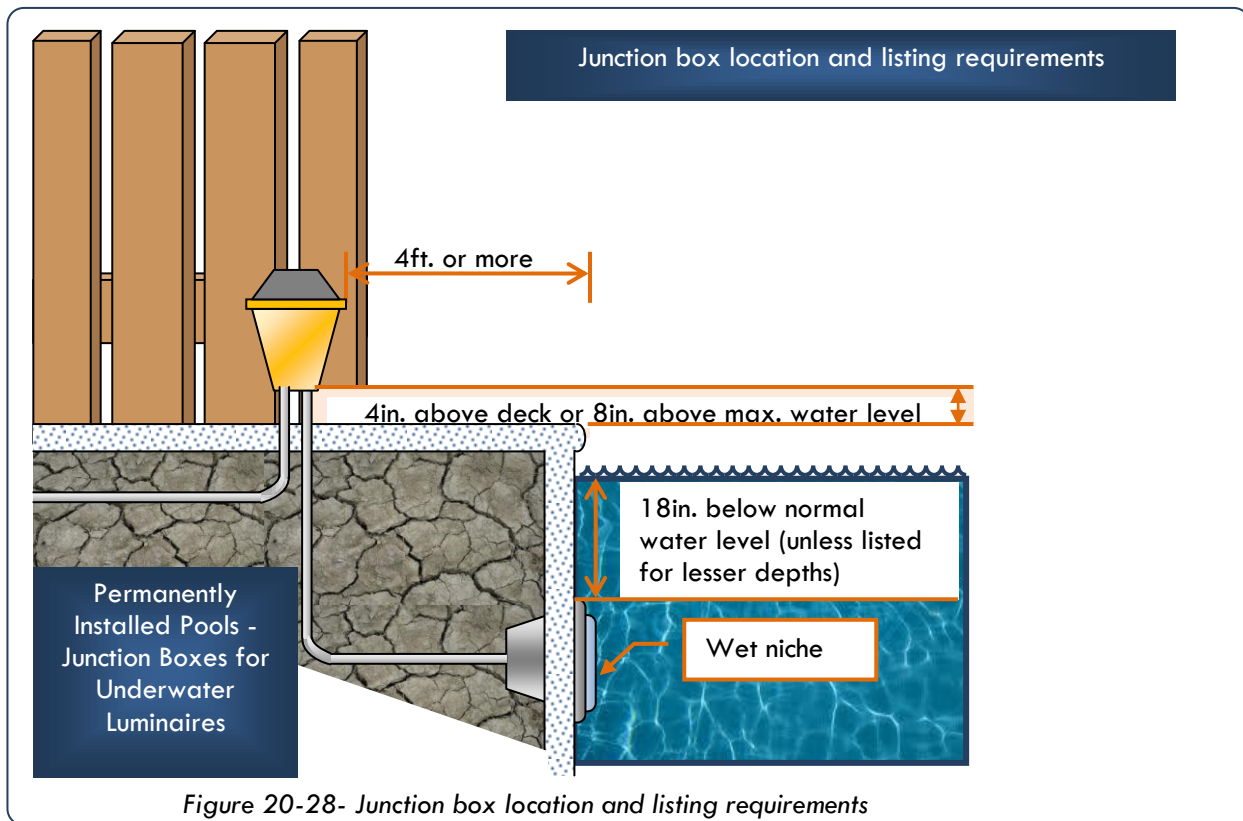

#### 20.22.6 EQUIPMENT ROOM AND PITS

Electrical equipment shall not be installed in rooms or pits that do not have adequate drainage to prevent water accumulation during normal operation or filter maintenance.

#### 20.23 BONDING

(FPN) It is not the intent of this section to require a No. 8 or larger solid copper bonding conductor be extended or attached to any remote panelboard, service equipment or any electrode but only that it be employed to eliminate voltage gradients in the pool area as prescribed.

1. Bonded Parts: The following parts shall be bonded together (see diagram below 1 through 6):

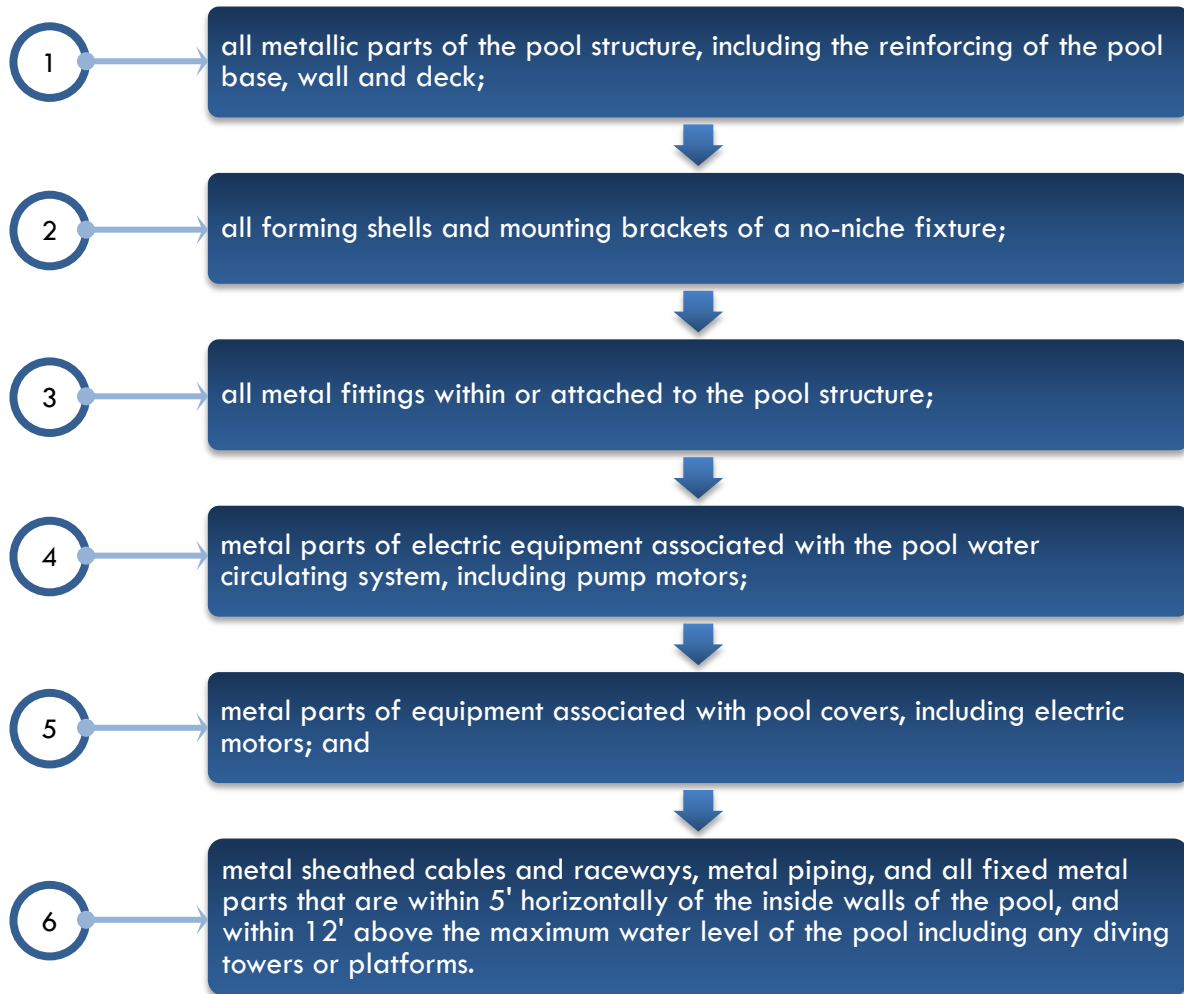

Figure 20-29- Bonding Requirements for a pool area

**Exception No. 1:**

The steel tie wires shall be considered suitable for bonding the reinforcing steel together, so that only one attachment to the bonding grid shall be required. These tie wires shall be made tight.

**Exception No. 2:** Isolated parts that are not over 4" in any dimension and do not penetrate into the pool structure more than 1" shall not require bonding.

**Exception No. 3:** Structural reinforcing steel or the walls of bolted or welded metal pool structures shall be permitted as a common bonding for non electric metal parts where connections are made by *approved* means.

**Exception No. 4:** Metal parts of listed equipment incorporating an approved system of double insulation and providing a means for grounding internal non-accessible, noncurrent carrying parts shall not be bonded.

2. **Common Bonding Grid:** The parts specified in section (1) above shall be connected to a common bonding grid with a solid copper conductor, insulated, covered or bare, not smaller than No. 8 wire. Connection shall be made by pressure connectors or clamps of stainless steel, brass, copper or copper alloy. The common bonding grid shall be permitted to be any of the following:
- 1) The structural reinforcing steel of a concrete pool where the reinforcing rods are bonded together by the usual steel tie wires; or
  - 2) The wall of a bolted or welded metal pool; or
  - 3) A solid copper conductor—insulated, covered or bare—not smaller than No. 8 wire.

Further, the common bonding grid must include the pool deck surrounding the pool to a width of 6' and include any conductive fencing or hose bib within 6' of the pool edge.

3. **Pool water Heaters:** For pool water heaters rated at more than 50-amperes that have specific instructions regarding bonding and grounding, only those parts designated to be bonded shall be bonded, and only those parts designated to be grounded shall be grounded.

### 20.23.1 GROUNDING

All grounding shall be in accordance with the National Electric Code. The following equipment shall be grounded:

- 1) wet-niche and no-niche underwater lighting fixtures;
- 2) dry-niche underwater lighting fixtures;
- 3) all electric equipment located within 5' of the inside wall of the pool;
- 4) all electric equipment associated with the recirculating system of the pool;
- 5) junction boxes;
- 6) transformer enclosures;
- 7) ground-fault circuit interrupters;
- 8) panelboards that are not part of the service equipment and that supply any electrical equipment associated with the pool.

### 20.24 SPAS AND HOT TUBS

#### 20.24.1 OUTDOOR INSTALLATIONS

A spa or hot tub installed outdoors shall comply with the requirements in accordance with a permanently installed swimming pool.

**Exception No. 1:** Metal bands or hoops used to secure wooden staves shall be exempt from the bonding requirements.

**Exception No. 2:** Listed packaged units shall be permitted to be cord and plug connected with a cord no longer than 15' if GFCI protected.



**Exception No. 3:** Bonding by metal-to-metal mounting on a common frame or base shall be permitted.

**Exception No. 4:** Listed packaged units utilising a factory installed remote panelboard shall be permitted to be connected with not more than 3' of liquid tight flexible conduit.

**Exception No. 5:** Equipotential bonding of perimeter surfaces shall not be required where all of the following apply:

- 1) The spa or hot tub shall be listed as a self-contained spa for above ground use;
- 2) The spa or hot tub shall not be identified as suitable only for indoor use;
- 3) The installation shall be located on or above grade and comply with the manufacturer's instruction; and
- 4) The top rim of the spa or hot tub shall be at least 28" above all perimeter surfaces that are within 30" horizontally from the spa or hot tub. The height of non-conductive external steps for access to the spa or hot tub shall not affect the rim height measurement.

#### **20.24.2 INDOOR INSTALLATIONS**

A spa or hot tub installed indoors shall conform to the following requirements:

##### **20.24.2.1 RECEPTACLES**

At least one receptacle shall be located a minimum of 6' from and not more than 20' from the inside wall of the spa or hot tub. All receptacles located within 20' of the inside walls of the spa or hot tub and those that provide power for the spa or hot tub shall be GFCI protected. Receptacles shall not be installed closer than 6' from the inside wall of the spa or hot tub.

##### **20.24.2.2 LIGHTING FIXTURES, LIGHTING OUTLETS AND CEILING FANS**

Lighting fixtures, lighting outlets and ceiling fans located over the spa or hot tub or within 5' from the inside walls of the spa or hot tub shall be a minimum of 7'-6" above the maximum water level and shall be GFCI protected.

**Exception No. 1:** Lighting fixtures, lighting outlets and ceiling fans located 12' or more above the maximum water level are not required to be GFCI protected.

**Exception No. 2:** Lighting fixtures meeting the requirements of items a or b below and protected by GFCI shall be permitted to be installed less than 7'-6" over a spa or hot tub.

- a) recessed fixtures with a glass or plastic lens and nonmetallic or electrically isolated metal trim, suitable for use in damp locations;
- b) surface-mounted fixtures with a glass or plastic globe and non-metallic or a metallic body isolated from contact. Such fixtures shall be suitable for use in damp locations.

##### **20.24.2.3 WALL SWITCHES**

Switches shall be located at least 5' measured horizontally from the inside walls of the spa or hot tub

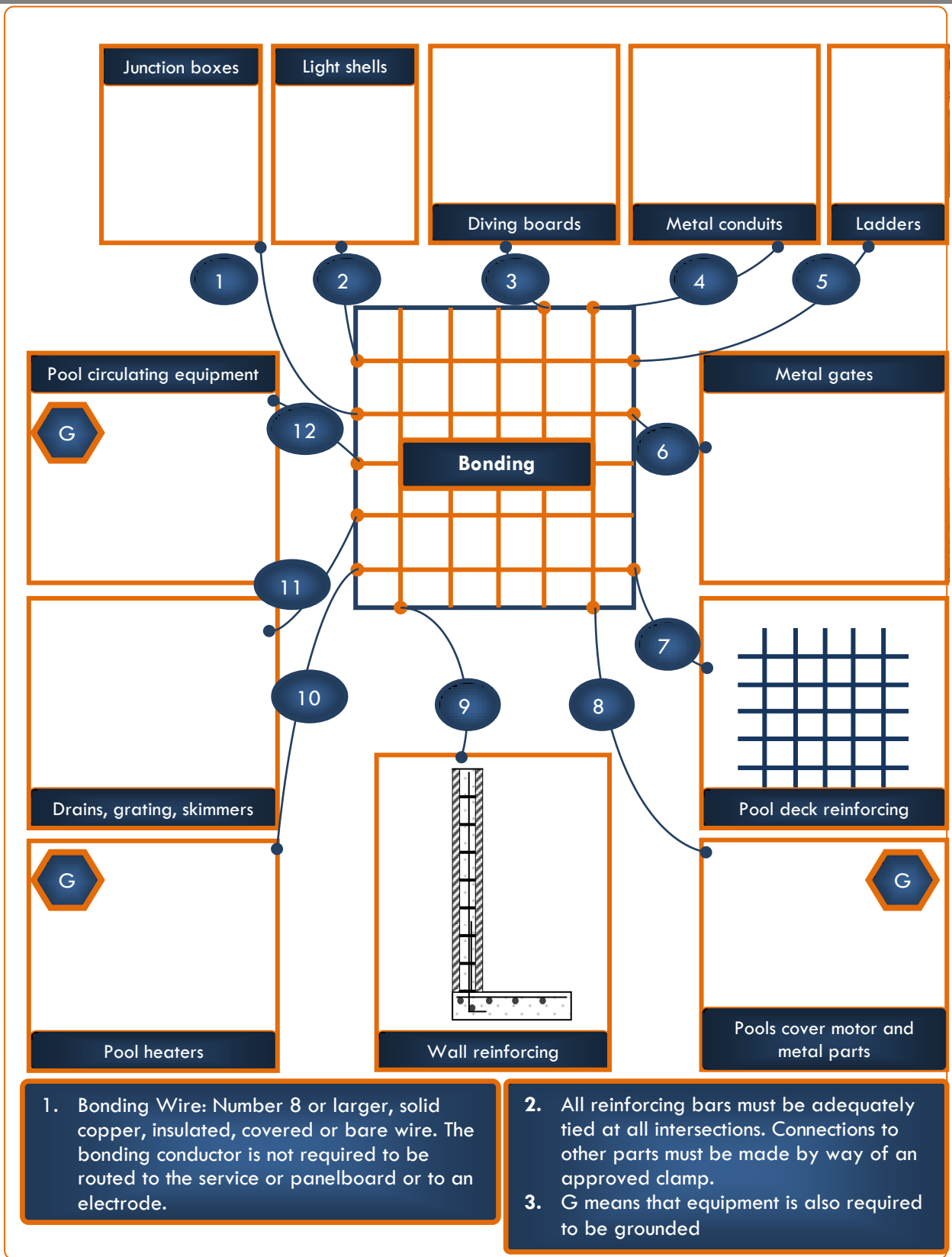

Figure 20-30- Bonding requirements for Swimming Pools

#### 20.24.2.4 DESIGN OF NON PACKAGED HOT TUBS AND SPAS

Non listed spa and hot tub designs may only be submitted by Registered Engineers and drawings shall bear stamps of both the Electrical and Mechanical Engineers responsible. The designs shall comply with the current BBC, IBC and NEC.

#### 20.24.2.5 GROUNDING

The following equipment shall be grounded:

- 1) all electric equipment located within 5' of the inside walls of the spa or hot tub.
- 2) all electric equipment associated with the circulating system of the spa or hot tub.

#### 20.24.2.6 PROTECTION

An outlet that supplies a self-contained spa or hot tub, or a packaged spa or hot tub equipment assembly, shall be GFCI protected.

### 20.25 HYDROMASSAGE BATHTUBS

#### 20.25.1 PROTECTION

Hydromassage bathtubs and their associated electrical components shall be protected by a GFCI. All receptacles within 5' of the inside walls of a hydromassage tub shall be GFCI protected. No receptacles shall be placed within 3' from the edge of a hydromassage bathtub.

#### 20.25.2 OTHER ELECTRIC EQUIPMENT

Lighting fixtures, switches, receptacles and other electric equipment located in the same room and not directly associated with a hydromassage bathtub shall be installed in accordance with the requirements covering the installation of equipment in *bathrooms*.

#### 20.25.3 ACCESSIBILITY

Hydromassage tub motors and their associated electrical connections must be accessible without damaging the building structure or finishes.

### 20.26 UNDERGROUND INSTALLATION OF WIRING

#### 20.26.1 MATERIALS

Only conductors, cables, or conduit listed for direct burial shall be used.

#### 20.26.2 MINIMUM DEPTH OF BURIAL

The minimum cover to any conductor, cable or conduits shall be as follows ([Figure 1.31](#)):

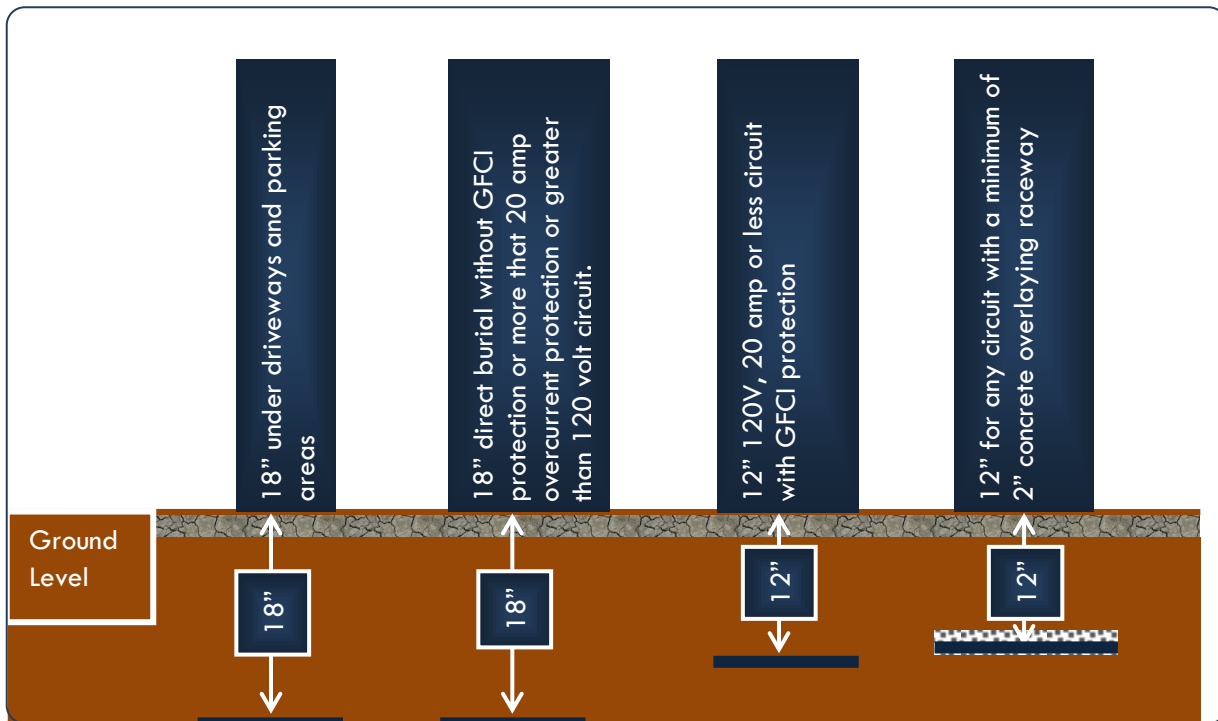

Figure 20-31- Minimum cover for cable burial

1. Direct burial of conductors, cables or conduit without concrete encasement: 18" below grade. (Exception: Circuits rated 120 volts or less, 20 amperes or less and GFCI protected: 12" below grade);
2. Conductors, cables or conduits covered by a minimum of 2" of concrete: 12" below grade;
3. Conductors, cables or conduits under driveways: 18" below grade.

### 20.26.3 BACKFILL

No backfill materials that comprise of large rock, paving materials, corrosive materials or any other materials that may cause damage to the conductors, cables or conduit shall be used.

### 20.26.4 SPLICES AND TAPS

Direct buried conductors or cables shall be permitted to be spliced or tapped without the use of splice boxes. The splices or taps shall be made by *approved* methods strictly in accordance with the NEC.

### 20.27 TEMPORARY WIRING

All temporary wiring at the construction site shall be in accordance with article 305 of the National Electrical Code. Ground fault circuit protection shall be provided for all temporary wiring in order to protect personnel.

### 20.28 NEUTRAL CONDUCTOR IDENTIFICATION

Neutral conductors 6 AWG and smaller must be identified by a continuous white or gray outer finish along their entire length, or by any color insulation (except green) with three white stripes, or by white or gray insulation with any color stripe (Figure 20.32).

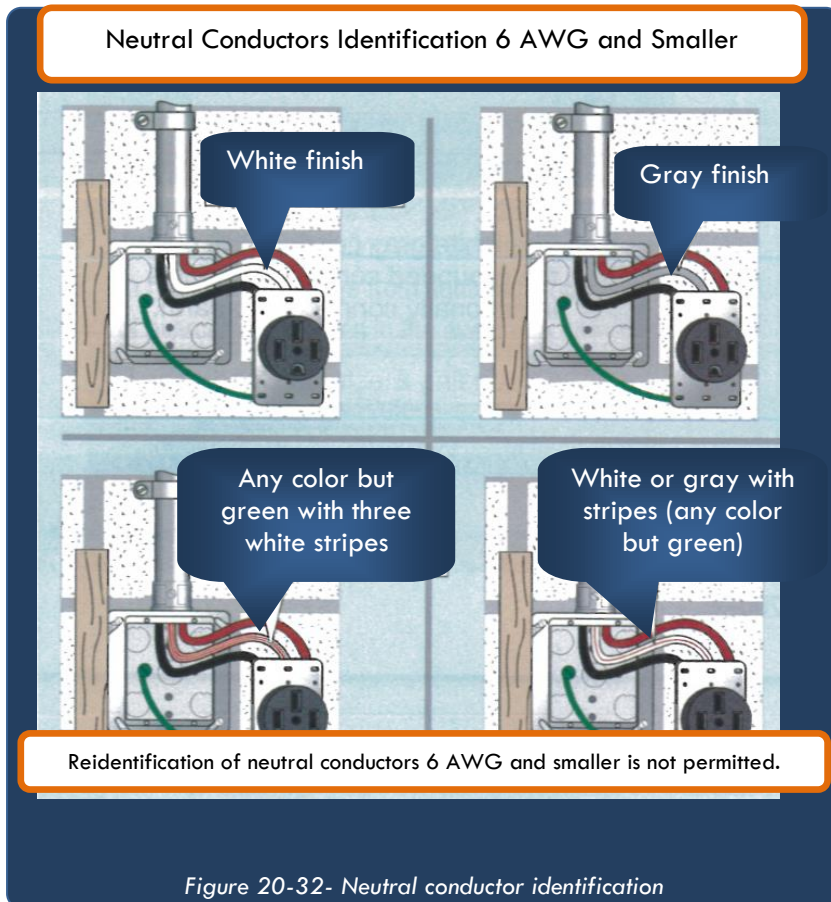

## 20.29 WIRING METHODS PERMITTED

Electrical metallic tubing, rigid metal conduit, intermediate metal conduit, armored cable, metal – clad cable without a nonmetallic cover, and flexible metal conduit can be installed in environmental air spaces.

Where accessible, surface metal raceways, metal raceways with metal covers, or solid bottom metal cable tray with solid metal covers can be installed in environmental air spaces ([Figure 1.33](#)).

1. PVC conduit, electrical nonmetallic tubing, Liquidtight flexible conduit and nonmetallic cables are not permitted to be installed in spaces used for environmental air because they give off deadly toxic fumes when burned or superheated unless FTP rated.
2. Control, signaling and communications cables installed in spaces used for environmental air must be suitable for plenum use.
  - CATV;
  - Communications;
  - Control and Signaling;
  - Fire Alarm;
  - Optical Fiber Cables and Raceways;
  - Sound Systems.

- Any wiring method suitable for this condition can be used in space not used for environmental air-handling purposes

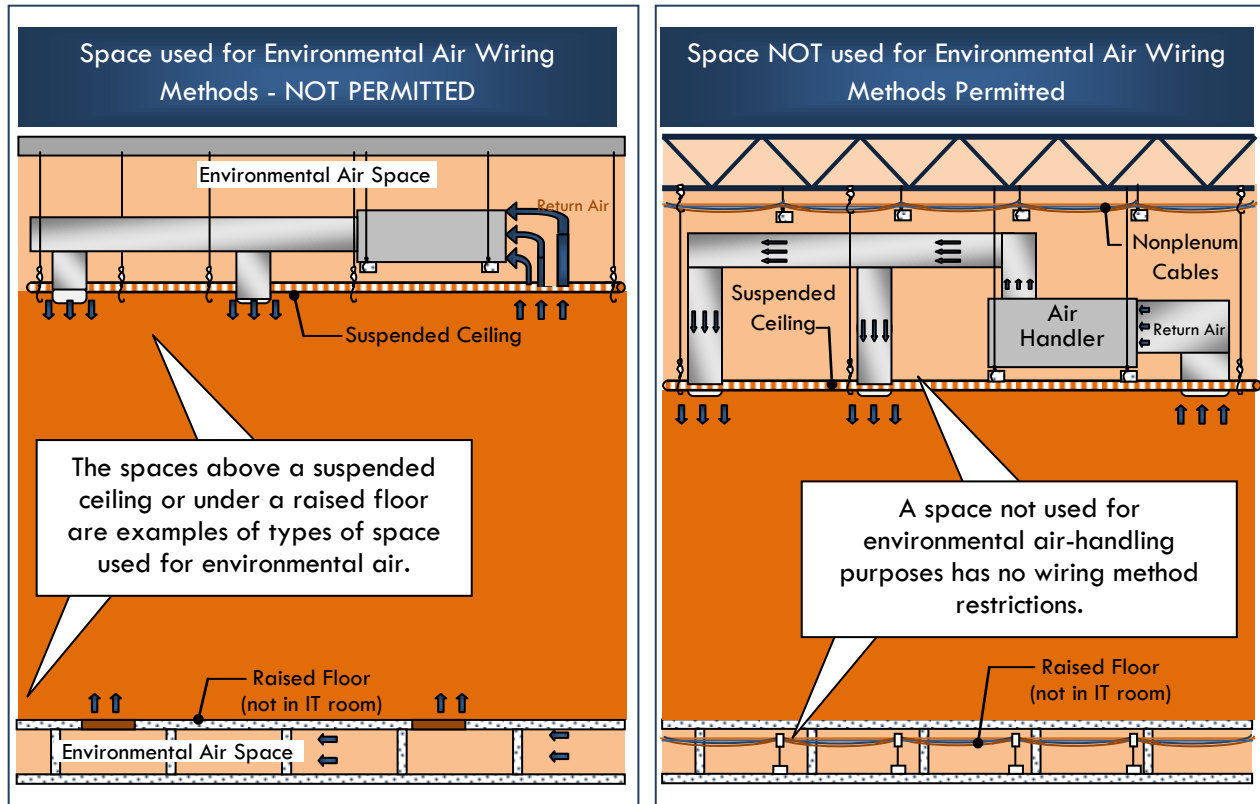

Figure 20-33- Environmental Air Wiring Methods

---

## 21 LPG EQUIPMENT & APPLIANCES

---

### 21.1 GENERAL

The storage and handling of liquefied petroleum gas shall be in accordance with the latest version of NFPA 58. The installation of the piping and appliances where not specified herein shall be in accordance with the provisions of the latest version of the International Mechanical Code published by the ICC.

### 21.2 PERMITS, INSPECTIONS & APPROVALS

No installation or renewal of gas piping and/or equipment shall commence prior to the issuance of a building permit. All works shall be inspected and approved by the *Building Official* prior to any gas being supplied.

### 21.3 CERTIFICATE OF INSTALLATION

Before any gas installation will be given a Certificate of Use and Occupancy the Gas, the Installing Company shall furnish the Department of Planning with a *Certificate of Installation*. Such a certificate shall identify the type of appliance(s) installed, its location in the dwelling, the results and date of the test referred to in section 22.14 and the name of the persons who carried out the installation. The certificate shall testify that all installation was in accordance with the required codes of practice and be signed by a suitable qualified person.

### 21.4 MAXIMUM DESIGN PRESSURE

The maximum design operating pressure of a system inside a building shall be 5 pounds per square inch.

### 21.5 UNDERGROUND GAS PIPING

Underground gas piping shall be installed to allow proper maintenance and to protect against contact or damage resulting from proximity to other structures. The minimum depth of underground piping system shall be 18" below grade or 12" below grade where covered by a minimum of 2" of concrete.

### 21.6 PIPING THROUGH WALLS

Where installed to pass through masonry walls, gas piping shall be installed in a sleeve at least two nominal pipe sizes larger than the gas pipe.

### 21.7 INSIDE BUILDING GAS PIPING

Gas piping shall be installed so as to prevent stress which will exceed the structural strength of the pipe. Pipes shall not be laid on any ground surface where subject to damage. Portions of a gas piping system in a permanently concealed location shall not have unions, fittings or running threads.

**21.8 IDENTIFICATION**

Where gas piping is installed inside anything other than exposed copper pipe, then the piping shall be labeled with pink tape or paint at intervals not exceeding 5' in order to clearly identify it.

**21.9 CONCRETE SLAB**

Gas piping embedded in concrete slabs shall be surrounded with a minimum of 1 ½" of concrete. The piping shall not be in contact with any metal.

**21.10 PROHIBITED LOCATIONS**

Gas piping shall not be run through air ducts, chimneys, vents, dumbwaiter or elevator shafts.

**21.11 PIPING MATERIALS**

Piping materials for the installation, alteration or repair of gas piping systems shall comply with Table 21.1. Only those piping systems identified shall be used. Plastic (polyethylene) pipes shall be installed underground and outside of buildings only.

LP Gas Pipe	
Material	Referenced standard
Copper or copper-alloy pipe	ASTM B43, ASTM B302
Copper or copper-alloy tube seamless	ASTM B88
Copper tube seamless	ASTM B280
Brass	ASTM B43
Galvanised steel	ASTM A53, ASTM A106
Polyethylene plastic pipe and tubing	ASTM D2513

Table 21.1 – LP Gas Pipe

**21.12 ELECTRICAL GROUNDING**

Gas piping shall not be used as a grounding electrode.

**21.13 SHUT OFF VALVE****21.13.1 EXTERIOR SHUT OFF**

A readily accessible exterior shut off valve shall be provided for each building.

**21.13.2 APPLIANCE CONNECTION**

Every gas appliance/outlet shall have an individual shut-off valve. The shut-off valve shall be accessible and within 6 feet of the appliance and in the same room. Shut-off valves for fireplaces shall be located outside the fireplace and the hearth and not more than 6 feet from the outlets.

**21.14 TESTING**

The gas piping system shall be tested before use. The required test shall be conducted by the gas installer and verified in writing. Portions of the gas piping system in concealed locations shall be tested before the piping is concealed. The system shall be tested with air to 10 PSI, and shall maintain the full-test pressure for a period of 15 minutes without a drop in pressure.



**21.15 CONTAINERS****21.15.1 LOCATION OF CONTAINERS**

LPG containers shall be located outside buildings and in accordance with the criteria listed below. The distance of the pressure relief valve and fill connection to the following shall be as follows:

<b>DOT Exchange Cylinders</b>	<b>DOT Site filled Storage Containers</b>	<b>ASME Site Filled Storage Containers</b>
a) minimum 3' horizontally from any window or crawl space/tank opening.	a) minimum 3' horizontally from any window or crawl space/tank opening.	a) minimum 5' horizontally from any window or crawl space/tank opening.
b) minimum 5' horizontally from any direct air intake vent.	b) minimum 10' from any direct air intake.	b) minimum 10' from any direct air intake.
c) minimum 5' horizontally from any appliance (source of ignition) such as air conditioner.	c) minimum 10' from any appliance (source of ignition) such as an air conditioner.	c) minimum 10' from any appliance (source of ignition) such as an air conditioner.
d) minimum of 5' horizontally from a boundary line.	d) minimum of 10' horizontally from a boundary line.	d) minimum of 10' horizontally from a boundary line.

Table 21.2 – Location of containers

**21.15.2 INSTALLATION OF CONTAINERS**

Containers shall be set upon a firm, level foundation, and firmly secured in position.

**21.15.3 ENCLOSURES**

Where enclosures are built to store LPG containers they shall have adequate openings to allow the escape of any vented gases.

**21.16 GAS FIRED WATER HEATERS****21.16.1 LOCATION**

Gas fired water heaters are not permitted in habitable rooms, bathrooms or clothes closets.

**21.16.2 EXHAUSTS**

All gas fired water heaters shall be exhausted through a flue to the outside of the building.

**21.16.3 VENTILATION**

Closets and other enclosed spaces containing gas fired water heaters shall be adequately ventilated. Vents shall be located at the top and bottom of the space within 6" of the ceiling and the floor and shall terminate to the outside of the building. The vents shall be of a minimum size of 100 square inches, but where required by the manufacturer's instructions, these sizes shall be increased accordingly.

**21.16.4 AUTOMATIC SHUT-OFF**

All gas fired water heaters shall be equipped with automatic devices designed to shut off the flow of gas to the main burner in the event that the pilot flame is extinguished. The system shall be equipped with a manual restart.

**21.16.5 GARAGE INSTALLATIONS**

Where gas fired water heaters are placed in garages, they shall be erected on a noncombustible platform a minimum of 18" above the level of the garage floor.

**21.16.6 INSTALLATION IN PUMP ROOMS**

Where gas fired water heaters are installed in the same rooms as electrically operated water pumps, the water pumps shall be installed on a platform a minimum of 12" above the level of the gas outlet of the water heater. The room shall be adequately ventilated in accordance with section 22.16.3 or in accordance with the manufacturer's specifications.

---

## 22 PLUMBING DEFINITIONS

---

**Air gap (plumbing):** The unobstructed vertical distance through free atmosphere between the lowest opening from a water supply discharge to the flood level rim of a plumbing fixture.

**Apartment house:** A residential building that contains three or more dwelling units.

**Branch interval:** A distance along a soil or waste stack corresponding in general to a storey height, but not less than 8 feet within which the horizontal branches from one floor or storey of a structure are connected to the stack.

**Branch vent:** A vent connecting 2 or more individual vents with a vent stack or stack vent.

**Branch:** Any part of a piping system apart from a riser, main or stack.

**Building drain (soil water):** The lowest part of the drainage piping system that collects the discharge from all other soil water drainage piping inside the house and conveys it to the building sewer (soil water) outside the building wall in a cesspit private sewage disposal system.

**Building drain (waste water):** The lowest part of the drainage piping system that collects the discharge from all other wastewater drainage piping inside the house and conveys it to the building sewer (waste water) outside the building wall in a cesspit private sewage disposal system.

**Building sewer Pipe:** That part of the drainage system that extends from the end of the building drain and conveys the discharge to a private sewage disposal system.

**Building sewer (soil water):** A building sewer pipe that conveys sewage from all bathroom fixtures in a cesspit sewage disposal system.

**Building sewer (waste water):** A building sewer pipe that conveys the liquid waste from kitchen/laundry appliances and fixtures in a cesspit sewage disposal system.

**Cesspit:** A covered excavation in the ground that receives the discharge of sewage and allows seepage of the liquid into the surrounding ground.

**Cleanout:** An access opening in the drainage system utilized for the removal of obstructions.

**Dead end (plumbing):** A branch of a drainage system that terminates at a developed length of 2 feet or more by means of a plug, cap or other closed fitting.

**Developed length (plumbing):** The length of pipe measured along the center line of the pipe and fittings.

**Drainage fixture unit (DFU):** A measure of the probable discharge into the drainage system by various types of plumbing fixtures.

**Effective opening:** The minimum cross-sectional area at the point of water supply discharge.

**Fullway valve:** A valve that in the open position has an opening cross sectional area equal to a minimum of 85% of the cross sectional area of the connecting pipe.

**Gray water or grey water:** Wastewater discharged from clothes washers, laundry trays, showers, bathtubs, sinks and lavatories. Note that kitchen sink wastewater is not considered gray water for the purposes of gray water recycling systems.

**Gutter:** A gently sloping channel to collect water and lead it to a drain.

**Holding Tank:** An approved watertight receptacle for collecting and holding sewage.

**Hot water:** Water that is supplied to plumbing fixtures at a temperature of between 120 and 140 degrees Fahrenheit.

**Kitchen trap:** An approved trap located outside the kitchen wall and designed to provide an air gap between the kitchen and/or laundry drainage piping and the building sewer (waste water) to the cesspit.

**Lavatory:** A hand basin for washing up.

**Plumbing fixture:** A receptor or device which requires both a water supply connection and a discharge to the drainage system.

**Private sewage disposal system:** A sewage treatment and disposal system serving one or more buildings on a single lot. It includes a cesspit, septic tank with borehole or sand filter or any similar system approved by the Department of Health or Environmental Authority.

**Riser (water pipe):** A water supply pipe which extends one full storey or more to convey water to branches or to a group of fixtures.

**Running trap:** A trap installed before the discharge of the building sewer (soil water) into the cesspit or sewer main.

**Septic tank:** A tank that receives and partially treats sewage through processes of sedimentation, floatation and bacterial action so as to separate solids from liquid. The liquid effluent is discharged to an approved disposal system.

**Sewage:** Any liquid waste containing animal or vegetable matter in suspension or solution including liquids that contain chemicals in solution.

**Soakaway pit:** A covered excavation in the ground that receives the discharge of tank or storm water and allows seepage of the liquid into the surrounding ground.

**Soil pipe:** A pipe that conveys sewage containing fecal matter to the building drain or building sewer.

**Stack pipe:** A vertical pipe which takes discharge from the parts of a building above ground down to the building sewer.

**Stack vent:** A drainage stack carried to the roof for the purposes of venting.

**Trap dip:** The top of the low point of the trap.

**Trap seal:** The vertical distance between the weir and the top of the dip of the trap.

**Trap weir:** The level that corresponds to the top of the water seal on the outlet side of the trap.

**Trap:** A fitting or device that provides a liquid seal to prevent the escape of sewer gases.

**Vent stack:** A vertical pipe installed to provide circulation to and from a drainage system which extends through one or more stories. It carries no drainage.

**Vent system:** A pipe or pipes installed to provide a flow of air to and from a drainage system or to provide a circulation of air within such system to prevent trap seals from siphonage or back pressure.

**Vent terminal:** The end of a vent pipe to a drainage system above the level of the roof of the building.

**Waste:** The discharge from any fixture, appliance, area or appurtenance that does not contain fecal matter.

**Waste pipe:** A pipe that conveys only waste.

**Waste stack:** A vertical pipe for carrying waste water.

**Waste water:** Water from sinks or washing not containing fecal matter.

**Water closet:** A toilet fixture.

**Water service pipe:** The outside pipe from the water main or water supply to the distribution system inside the building, terminating at the service valve.

**Wet vent:** A vent which also receives the discharge of wastes from other fixtures.



## 23 PLUMBING

---

### 23.1 GENERAL

All plumbing and drainage shall be in accordance with the Public Health Act, 1949, the Plumbing and Drainage Regulations 1965, the City of Hamilton Sewage Act 1951, and any subsequent regulations, revisions or amendments. Where not specified herein the materials, joints, fixtures, devices and installation shall be in accordance with the International Plumbing Code 2012 published by the International Code Council.

### 23.2 PERMITS, INSPECTIONS & APPROVALS

No installation or renewal of plumbing or drainage piping and systems shall commence prior to the issuance of a building permit. All works shall be inspected and approved by the Department of Health prior to use. Works to be concealed shall be left exposed until a rough-in inspection has been performed.

**Exception:** Permits are not required for the replacement of existing fittings and fixtures with new fittings if such new fittings meet the requirements of the code.

### 23.3 INSPECTIONS & TESTS

Drainage, waste, and vent systems shall be tested on completion of the rough piping installation by water or air with no evidence of leakage. Either test shall be applied to the drainage system in its entirety or in sections after rough piping has been installed as follows:

- a) **Water test.** Each section shall be filled with water to a point not less than 10 feet above the highest fitting connection in that section, or to the highest point in the completed system. Water shall be held in the section for a period of 15 minutes. The system shall prove to be leak free by visual inspection.
- b) **Air test:** The portion under test shall be maintained at a gauge pressure of 5 pounds per square inch or 10 inches of mercury column. This pressure shall be held without introduction of additional air for at least 15 minutes.

#### 23.3.1 WATER SYSTEM SUPPLY TESTING

Upon completion of the water supply system or section of it, the system or portion completed shall be tested and proved tight under a water pressure of not less than 100 psi, or for piping systems other than plastic, by an air test of not less than 50 psi. The pressure shall be held for a minimum of 15 minutes. The water used for such tests shall be from a potable source.

#### 23.3.2 WATER CATCHMENT AND TANK INSPECTION

Any new or altered tank and/or water catchment shall be clean and free of construction material or debris.

### 23.4 WATER SUPPLY PIPE AND FIXTURE PURGING

New or repaired potable water supply pipes and fixtures shall be purged of deleterious matter prior to utilisation.

## 23.5 GENERAL REQUIREMENTS

### 23.5.1 TRENCHING & BACKFILLING

Where trenches are excavated such that the bottom of the trench forms the bed for the pipe, solid and continuous load bearing support shall be provided between joints. Where over excavated, the trench shall be backfilled to the proper grade with compacted earth, sand, fine gravel or similar granular material. Piping shall not be supported on rocks or blocks at any point. Rocky or unstable soil shall be over excavated by two or more pipe diameters and brought to the proper grade with suitable compacted granular material.

### 23.5.2 BACKFILLING

Backfill shall be free of discarded construction material and debris. Backfill shall be free from rocks and broken concrete until the pipe is covered by at least 12 inches of tamped earth. Backfill shall be placed evenly on both sides of the pipe and tamped to retain proper alignment. Loose earth shall be carefully placed in the trench in 6 inch layers and tamped in place.

### 23.5.3 PROTECTION OF FOOTINGS

Trenching installed parallel to footings shall not extend below the 45 degree bearing plane of the bottom edge of the wall or footing as shown in Fig 24.1. Where laid under a footing, the pipe shall be surrounded with concrete a minimum of 6 inches thick.

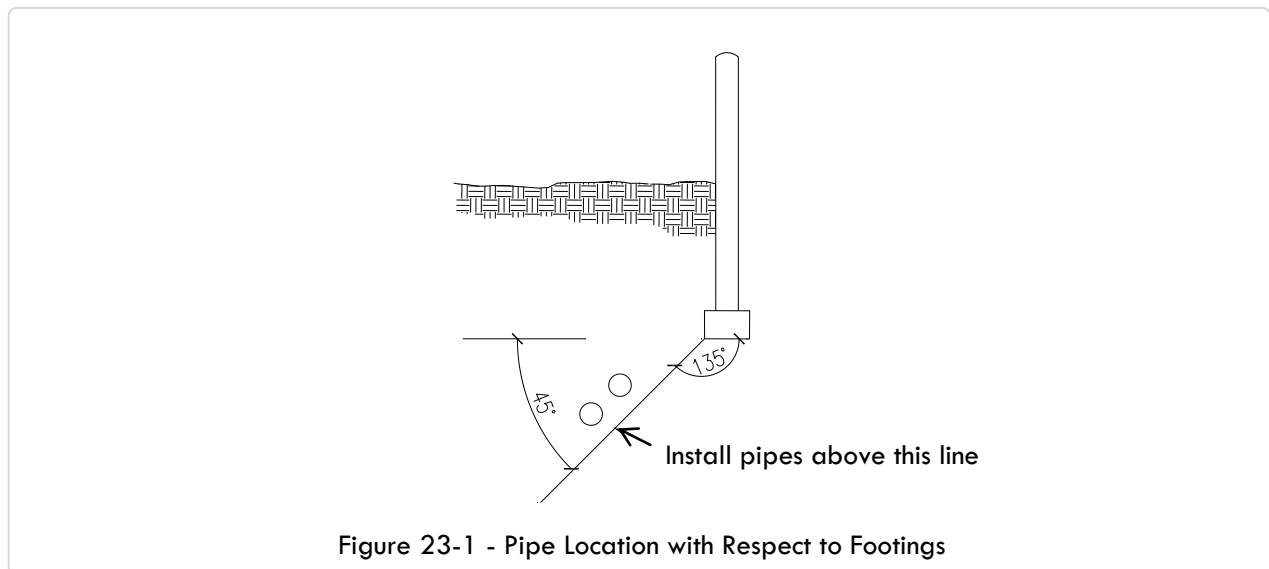

## 23.6 PIPING SUPPORT

### 23.6.1 GENERAL

All plumbing and drainage piping shall be supported in accordance with this section.

### 23.6.2 MATERIALS

Hangers, anchors and supports shall be adequate to support the piping and contents of the piping. The material shall be such that it will not promote galvanic corrosion.



**23.6.3 INTERVAL OF SUPPORT**

Piping shall be supported in accordance with Table 24.1.

Maximum Allowable Spacing of Hangers		
Piping Material	Maximum Horizontal Spacing	Maximum Vertical Spacing
PVC	4'	10'
CPVC 1" or smaller	3'	5'
CPVC 1 1/4" or larger	4'	6'
Copper 1 1/4" and smaller	6'	10'
Copper 1 1/4" and larger	10'	10'
Brass	10'	10'

Table 23.1 - Maximum Allowable Spacing of Hangers

**23.6.4 STACKS**

Bases of stacks outside of walls shall be supported by a concrete pad or metal brackets attached to the building (Fig. 24.2).

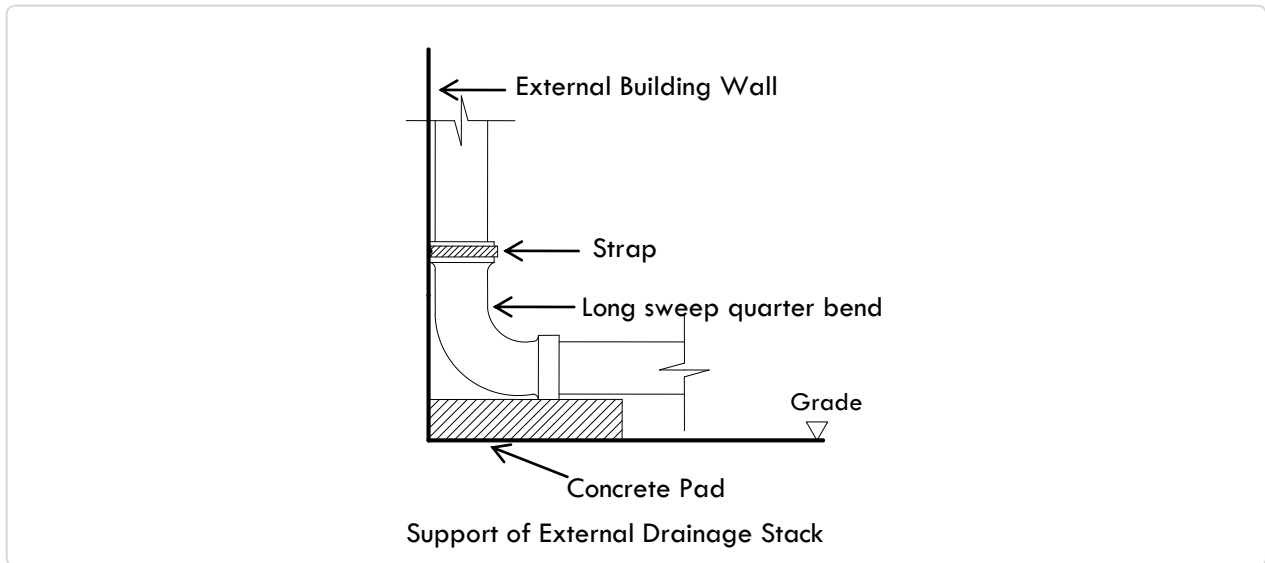

Figure 23-2 - Connection of Stack Outside of Wall

**23.7 IDENTIFICATION OF MATERIALS**

Each length of pipe and each pipe fitting, trap, fixture, material and device used in a plumbing system shall have stamped or indelibly marked on it the manufacturer's mark, as well as the quality of the product or identification in accordance with the approved standard.

**23.8 NOMINAL PIPE SIZES**

The nominal pipe sizes referred to in this document are in accordance with Table 24.2. The nominal sizes refer to the internal diameter of the pipe.

Nominal Pipe Size
1/4"
3/8"
1/2"
3/4"
1"
1 1/4"
1 1/2"
2"
2 1/2"
3"
3 1/2"
4"
5"
6"
8"
10"
12"

Table 23.2 - Nominal Pipe Sizes

**23.9 WORKMANSHIP**

Valves, pipes and fittings shall be installed in correct relationship to the direction of flow.

---

## **24 DRAINAGE**

---

### **24.1 GENERAL**

A private sewage disposal system shall be provided within each residential lot for the exclusive use of buildings erected therein. Every building having plumbing fixtures installed shall have a separate connection or share a common sewer to the private sewage disposal system. Alternatively, a connection to a public or private sewer shall be permitted where available. Where cesspits are used, kitchen and laundry drainage shall be kept entirely separate from bathroom drainage.

### **24.2 CONNECTION TO SANITARY DRAINAGE SYSTEM**

Plumbing fixtures, drains and appliances used to receive or discharge gray water or sewage shall be connected to the sanitary drainage system of the building or premises in accordance with the requirements of this code.

**Exception:** Bathtubs, showers, lavatories, clothes washers and laundry tubs shall not be required to discharge to the sanitary drainage system where such fixtures discharge to an approved gray water system for flushing of water closets and urinals or for subsurface landscape drainage in accordance with Section 26.15.

### **24.3 GRAVITY FLOW**

Wherever practicable, the gray water and sewage systems shall be designed so that flow is achieved by gravity.

### **24.4 DISCHARGE OF RAINWATER**

No water catchment leader or surface water drain pipe shall discharge into or connect with any soil pipe, ventilating pipe or waste pipe.

### **24.5 DRAINAGE PIPES ABOVE WATER TANKS OR POTABLE WATER COLLECTION AREAS**

No soil, waste, storm, condensate, vent or drainage pipe shall be positioned as to run through, over or in the top or wall of any water storage tank or potable water collection area.

**Exception:** Where soil, waste or drain pipes are installed in blockwork walls that are situated around the perimeter of the water tank, the pipe shall exit the wall a minimum of 2 feet above the tank top. The block work must be solid filled with concrete to a height of 2 feet above the tank top, for a horizontal distance of at least 2 feet either side of the drain pipe.

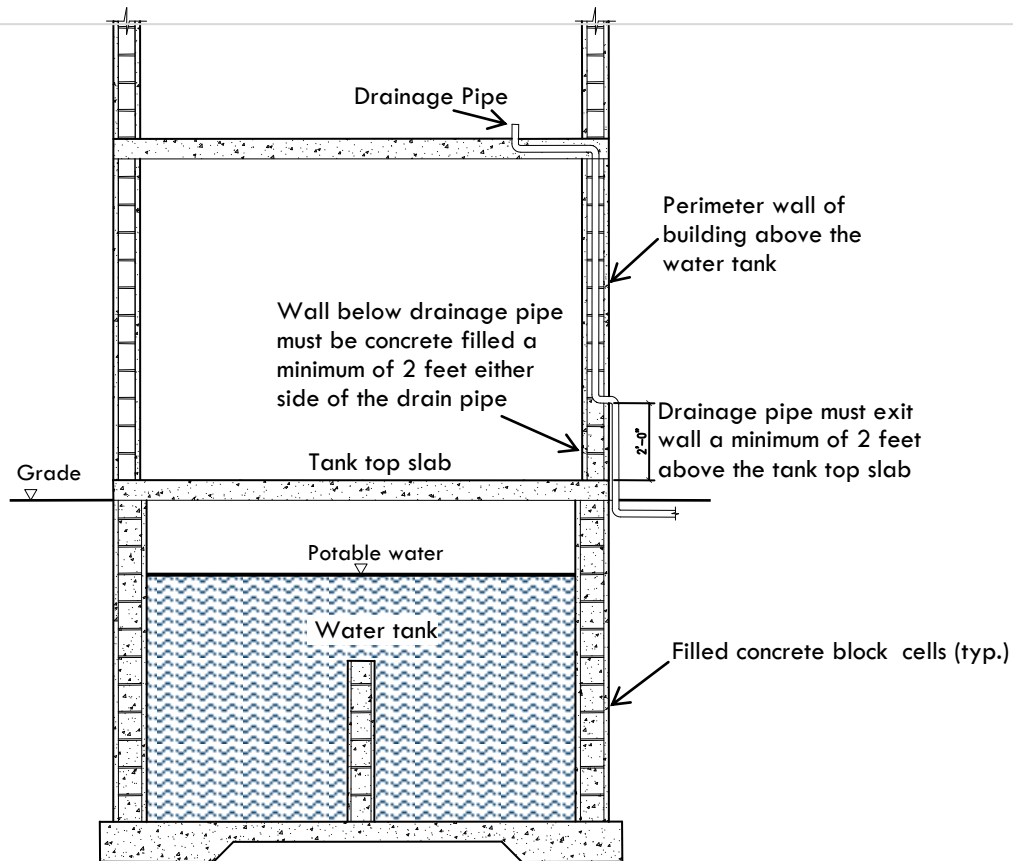

Figure 24-1 - Drainage Pipes above Water Tanks

## 24.6 OUTDOOR SHOWER DRAINS

Outdoor shower drains shall discharge into a 3 foot x 3 foot x 4 foot soakaway pit.

## 24.7 PROHIBITED LOCATION OF STORM AND TANK WATER PIPE OUTLETS

No storm water drain or tank overflow pipe shall terminate on the shoreline or onto any road.

## 24.8 SANITARY DRAINAGE

### 24.8.1 JOINTS & CONNECTIONS

#### 24.8.1.1 TIGHTNESS

Joints and connections to the Drainage, Waste and Vent (DWV) system shall be gas tight and water tight for the intended use or pressure required by test.

#### 24.8.1.2 *PROHIBITED JOINTS*

The following types of joints and connections shall be prohibited:

1. Cement or concrete joints or connections..
2. Mastic or hot pour bituminous joints.
3. Joints made with fittings not approved for the specific installation.
4. Joints between different diameter pipes made with elastomeric rolling O rings.
5. Solvent cement joints between different types of plastic pipe.
6. Saddle type fittings.

#### 24.8.1.3 *APPROVED JOINTS AND CONNECTIONS*

Methods of joining and connecting approved materials shall comply with the International Plumbing Code 2012.

#### 24.8.1.4 *SOLVENT CEMENT PRIMER*

All joints must be primed with purple colored primer conforming to ASTM 656 immediately prior to cementing PVC and CPVC pipe and fittings.

### 24.9 **DRAINAGE PIPE CLEANOUTS**

#### 24.9.1 **MATERIALS**

Cleanouts shall be liquid and gas tight. Cleanout plugs shall be brass or plastic.

#### 24.9.2 **SPACING**

Cleanouts shall be installed not more than 50 feet apart in horizontal drainage lines measured from the upstream entrance of the cleanout.

#### 24.9.3 **UNDERGROUND DRAINAGE CLEANOUTS**

When installed in underground drains, cleanouts shall be extended vertically to or above finished grade either inside or outside of the building.

#### 24.9.4 **CHANGE OF DIRECTION**

Cleanouts shall be installed at each fitting with a change in direction more than 45 degrees in the building sewer, building drain and horizontal waste or soil lines. Where more than one change in direction occurs in a run of piping, only one cleanout shall be required in each 40 feet of developed length of drainage piping.

#### 24.9.5 **ACCESSIBILITY**

Cleanouts shall be accessible.

#### 24.9.6 **BASE OF STACKS**

Accessible cleanouts shall be provided near the base of each vertical waste or soil stack. Alternatively, such cleanouts shall be installed outside the building within 3 feet of the building wall.

##### 24.9.6.1 **BUILDING DRAIN AND BUILDING SEWER CONNECTION**

There shall be a cleanout near the junction of the building drain and building sewer. This cleanout shall be inside or outside of the building wall provided that it is brought up to finished grade or to the lowest floor level.

**24.9.7 DIRECTION OF FLOW**

Cleanouts shall be installed so that the cleanout opens to allow cleaning in the direction of flow of the drainage line.

**24.9.8 CLEANOUT SIZE**

Cleanouts shall be the same nominal size as the pipe they serve, up to 4 inches. For pipes greater than 4 inches nominal size, the minimum size of the cleanout shall be 4 inches.

**24.9.9 CLEANOUT EQUIVALENT**

A fixture trap or a fixture with an integral trap, readily removable without disturbing concealed piping shall be acceptable as a cleanout equivalent.

**24.10 SLOPE OF HORIZONTAL DRAINAGE PIPES****24.10.1 HORIZONTAL DRAINAGE PIPE SLOPE**

Horizontal drainage piping shall be installed in uniform alignment at uniform slopes not less than  $\frac{1}{4}$  inch unit vertical in 12 units horizontal (2 percent slope) for 2- $\frac{1}{2}$  inch diameter pipes or less, and not less than  $\frac{1}{8}$ <sup>th</sup> unit vertical in 12 units horizontal (1 percent slope) for diameters of 3 inches or more.

**24.11 UNDERGROUND SEWER AND DRAIN PIPES****24.11.1 MATERIALS**

Underground drain and sewer pipes shall be as shown in Table 25.1.

<b>UNDERGROUND SEWER AND DRAIN PIPES</b>	
<b>Material</b>	<b>Referenced Standard</b>
Copper or Copper Alloy	ASTM B75, ASTM B88, ASTM B251
Vitrified Clay	ASTM C425, ASTM C700
PVC Schedule 40	ASTM D2665, ASTM D2949, ASTM F891

Table 24.1 – Underground sewer and drain pipes

**24.11.2 FITTINGS**

Fittings shall be approved and compatible with the type of pipe being used and shall be of a sanitary or DWV design for drainage and venting. Drainage fittings shall have a smooth interior waterway of the same diameter as the piping served. Drainage fittings shall have no ledges, shoulders or reductions which can retard or obstruct drainage flow in the piping.

**24.11.3 CESSPIT SEWER SIZES**

Two separate building sewers are required for cesspit waste disposal systems, one to convey the discharge of all bathroom fixtures (soil pipe) and one sewer pipe for kitchen and laundry fixture discharges. The bathroom soil sewer pipe shall be no less than 4 inches in diameter. Kitchen and laundry drainage shall be conveyed to the pit via a 3 inch or greater waste sewer pipe.

**24.11.4 VENTED TRAP REQUIRED**

A vented trap shall be provided where the kitchen and/or laundry drain exits the building and connects to the kitchen/laundry waste sewer pipe. See Fig 25-3 for construction details for the vented trap.

**RUNNING TRAP  
(with vent offset)**

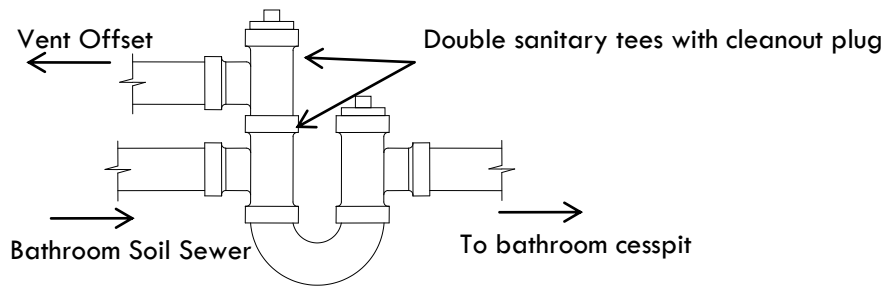

Figure 24-2 – Running Trap Vent Offset

**24.11.5 RUNNING TRAP & VENT**

A running trap and vent are required on the bathroom (soil) sewer pipe. It shall be located at the point where the soil pipe enters the cesspit. The vent on the running trap shall be a minimum of 3 inches above grade and located on the building side of the trap. A cleanout plug shall be used on the cesspit side of the trap.

**24.11.6 OFFSETS TO RUNNING TRAP VENTS**

Where vents are offset, a sanitary tee with cleanout plug shall be positioned directly above the running trap tee to connect the vent offset pipe (Figure 25-2).

**VENTED TRAP SYSTEM  
(for kitchen/laundry drains)**

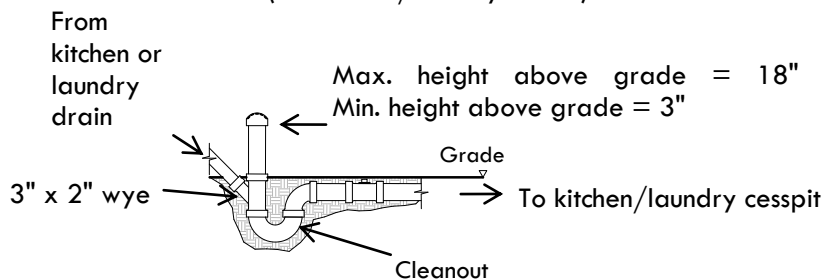

Figure 24-3 – Kitchen/Laundry

**24.11.7 DRAINAGE FOR SEWAGE DISPOSAL SYSTEMS OTHER THAN CESSPITS**

A single drainage system shall be permitted where septic tanks or sewer systems are used. An inspection chamber shall be provided where the building sewer pipe connects to the sewer branch within the property line. The running trap on the building sewer shall be omitted where the septic tanks are not vented.

**24.12 ABOVE GROUND DRAINAGE****24.12.1 MATERIALS**

Above ground drainage pipes shall be as shown in Table 25.2.

Above Ground Drainage Piping	
Material	Referenced Standard
Copper or Copper Alloy	ASTM B75, ASTM B88, ASTM B251, ASTM B306
Brass	ASTM B43
PVC Schedule 40	ASTM D2665, ASTM D2949, ASTM F891

Table 24.2 - Above Ground Drainage Piping

**24.13 DRAINAGE, WASTE, VENT (DWV) HORIZONTAL PIPES AND BRANCHES****24.13.1 DETERMINING DRAINAGE FIXTURE UNITS**

The load on DWV system piping shall be computed in terms of drainage fixture unit (D.F.U.) values in accordance with Table 25.3

Drainage Fixture Values for Various Plumbing Fixtures	
Type of Fixture or Group of Fixtures	Drainage Fixture Unit Value
Bar Sink	1
Bathtub (with or without showerhead and or whirlpool attachments)	2
Bidet	1
Clothes Washer Standpipe	2
Dishwasher	2
Floor Drain	0
Kitchen Sink	2
Lavatory	1
Laundry Tub	2
Shower Stall	2
Water Closet (1.6 gal. per flush)	3
Full bath group with bathtub with or without shower head, 1.6 gal. toilet, lavatory	5
Half bath (1.6 gal. per flush water closet)	4
Kitchen group (dishwasher & sink)	2
Laundry group (clothes washer standpipe & laundry tub)	3
Multiple bath groups:	
1.5 baths	7
2 baths	8
2.5 baths	9
3 baths	10
3.5 baths	11

Table 24.3 - Drainage Fixture Values for Various Plumbing Fixtures



**24.13.2 SIZING OF HORIZONTAL DRAINAGE PIPES AND BRANCHES**

**24.13.2.1 DFU'S**

The drainage pipes shall be sized in accordance with the number of DFU's as listed in Table 25.4

**Exception:** The building drain shall be at least 4 inches in diameter.

Maximum Fixture Units Allowed to be connected to Branches and Stacks	
Internal Diameter of Pipe	Total Allowable DFU's
1-1/2" <sup>A</sup>	3
2" <sup>A</sup>	6
2-1/2" <sup>A</sup>	12
3"	20
4"	160

<sup>A</sup> No water closets

**Table 24.4 - Maximum Fixture Units Allowed to be connected to Branches and Stacks**

**24.13.2.2 DRAINAGE STACK PIPES**

Stack pipes shall be a minimum of 3" in diameter, which shall be adequate to carry 48 D.F.U.'s. For plumbing loads greater than this value, a 4" stack pipe shall be used. They shall not be smaller than the largest horizontal branch connected. The stack shall be vertical and not have any bend greater than 45 degrees.

**24.14 DRAINAGE FITTINGS & CONNECTIONS**

Changes in direction in drainage piping shall be made by the appropriate use of sanitary tees, wyes, sweeps, and bends, or by a combination of the drainage fittings in accordance with Table 25.5.

Fittings for Change in Direction			
TYPE OF FITTING PATTERN	Change in Direction		
	Horizontal to vertical	Vertical to horizontal	Horizontal to horizontal
Sixteenth bend	yes	yes	yes
Eighth bend	yes	yes	yes
Quarter bend (short sweep)	yes	Yes – if 2 inch or smaller fixture drain <sup>A</sup>	Yes if 2 inch or smaller fixture drain <sup>A</sup>
Long sweep	yes	yes	yes
Sanitary tee	yes	no	no
Wye	yes	yes	yes
Combination wye & eighth bend	yes	yes	yes

<sup>A</sup> Fitting only used for a single fixture

**Table 24.5 - Fittings for Change in Direction**

**24.15 PROHIBITED CONNECTIONS**

- a. No fitting that incorporates a straight T branch shall be used as a drainage fitting.
- b. No fitting or connection that has an enlargement chamber or that has a recess with a ledge or shoulder, or that incorporates a reduction in pipe area shall be used.
- c. No running threads, bands or saddles shall be used in a drainage system.

- d. No drainage pipe or vent piping shall be drilled, tapped, burned or welded.

#### **24.16**     **DEAD ENDS**

Dead ends shall be prohibited except where necessary to extend a cleanout or as an approved part of a rough in more than 2 feet in length.

#### **24.17**     **CHANGE IN SIZE**

The size in drainage piping shall not be reduced in the direction of flow. A 4 inch by 3 inch water closet connection shall not be considered a reduction in size.

#### **24.18**     **SUMPS AND EJECTORS**

##### **24.18.1**    **LOCATION**

Where practicable, sewage ejector equipment and sumps shall be located outside of the building.

##### **24.18.2**    **DESIGN**

A sewage ejector pump or grinder pump receiving the discharge from a water closet shall have a minimum velocity of 1.9 feet per second throughout the discharge piping to the point of connection with a gravity building drain, gravity sewer or pressure sewer system. A non grinding pump shall be capable of passing a 1-½ inch diameter solid ball and the discharge piping shall not be less than 2 inches in diameter. A check valve and a gate valve located on the discharge side of the check valve shall be installed in the pump or ejector discharge piping between the pump or ejector and the drainage system. Access shall be provided to such valves. Such valves shall be located above the sump cover, or where the discharge pipe is below grade the valves shall be accessibly located outside the sump below grade in an access pit with a removable access cover.

**Exception:** Macerating toilet systems shall be permitted to have the discharge pipe sized in accordance with the manufacturer's instructions, but not less than 0.75 inch diameter.

#### **24.19**     **BUILDING DRAINS BELOW SEWER**

Building drains which cannot be discharged to the sewer by gravity flow shall be discharged into a tightly covered and vented sump from which the contents shall be lifted and discharged into the building gravity drainage system by automatic pumping equipment.

#### **24.20**     **FIXTURE TRAPS**

##### **24.20.1**    **GENERAL**

Each plumbing fixture shall be separately trapped by a water seal trap. The vertical distance from the fixture outlet to the trap weir shall not exceed 24 inches and the horizontal distance shall not exceed 30 inches measured from the center line of the fixture outlet to the center line of the inlet of the trap. A fixture shall not drain into more than one trap prior to connecting to the vented trap or running trap on the sewer pipes.

##### **Exceptions:**

- a. This section shall not apply to fixtures that have integral traps.
- b. A single trap shall be permitted to serve two or three like fixtures limited to kitchen sinks, laundry tubs and lavatories. Such fixtures shall be adjacent to each other and located within

the same room with a continuous waste arrangement. The trap shall be installed at the center fixture where three fixtures are installed. Common trap fixtures shall not be more than 30 inches apart.

- c. Connection of a laundry tub waste line into a standpipe for an automatic clothes washer drain is permitted where the stand pipe is greater than 30 inches as measured from the trap weir and the outlet of the laundry tub is less than 30 inches from the stand pipe trap.

**24.20.2 DESIGN OF TRAPS**

Fixture traps shall be self scouring. Fixture traps shall not have interior partitions, except where such traps are integral with the fixture or where such traps are constructed of an approved material that is resistant to corrosion and degradation. Slip joints shall be made with an approved elastomeric gasket and shall be installed only on the trap inlet, trap outlet and within the trap seal.

**24.20.3 TRAP SEALS**

Each fixture trap shall have a trap seal of not less than 2 inches and not more than 4 inches.

**24.20.4 CLOTHES WASHER STAND PIPE**

The height of a clothes washer standpipe above the trap shall be a minimum of 18 inches and a maximum of 42 inches above the trap weir.

**24.20.5 TRAP SETTING AND PROTECTION**

Traps shall be set level with respect to their water seals and shall be protected from siphonage, aspiration or back pressure by an approved system of venting.

**24.20.6 SIZE OF FIXTURE TRAPS**

Fixture trap size shall be sufficient to drain the fixture rapidly and not less than the size indicated in

<b>Minimum Trap Sizes for Fixtures</b>	
Plumbing Fixture	Trap Size (minimum inches)
Bathtub	1-1/2
Bidet	1-1/4
Clothes washer stand pipe	2
Dishwasher (on separate trap)	1-1/2
Floor drain	2
Kitchen sink (with or without dishwasher)	1-1/2
Laundry tub	1-1/2
Lavatory	1-1/4
<b>Shower (based on total flow rate through shower heads and body sprays)</b>	
5.7 gpm or less	1-1/2
More than 5.7 gpm up to 12.3 gpm	2
More than 12.3 gpm up to 25.8 gpm	3
More than 25.8 up to 55.6 gpm	4
Water closet	Fixture specific

Table 24.6 - Minimum Trap Sizes for Fixtures



---

## **25 VENTS**

---

### **25.1 TRAP SEAL PREVENTION**

The plumbing system shall be provided with a system of vent piping that will permit the admission and emission of air so that the seal of any fixture trap shall not be subject to a pneumatic pressure differential of more than 1 inch of water column.

### **25.2 VENTING REQUIRED**

Every trap and trapped fixture shall be vented in accordance with one of the venting methods specified in this section.

### **25.3 LIMITATIONS**

The plumbing vent system shall not be used for purposes other than the venting of the plumbing system.

### **25.4 TERMINATION**

Vent pipes shall extend a minimum of 6 inches above the high side of the penetration through the roof.

### **25.5 LOCATION OF VENT TERMINAL**

Vent terminals shall not be located beneath doors, windows or other openings, nor shall a vent terminal be within 5 feet horizontally of an opening to the interior unless it is at least 2 feet above the top of such opening. Side wall vent openings shall be protected to prevent birds or rodents from entering or blocking the vent opening.

### **25.6 VENT CONNECTIONS AND GRADES**

All individual branch and circuit vents shall connect to a stack vent, vent stack or shall extend to the open air.

**Exception:** Individual vents shall be permitted to terminate at an air admittance valve in accordance with Section 26.13.

### **25.7 GRADE**

Vent and branch vent pipes shall be graded, connected, and supported to allow moisture and condensate to drain back to the soil or waste pipe by gravity.

### **25.8 VENT CONNECTION TO DRAINAGE SYSTEM**

Every dry vent connecting to a horizontal drain shall connect above the centerline of the horizontal drain pipe as shown in Fig 26.1.

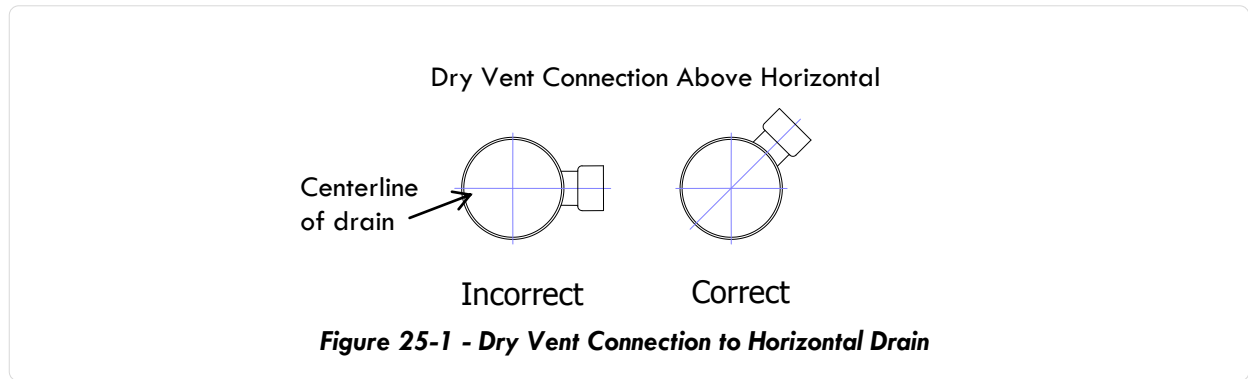

## 25.9 VERTICAL RISE OF VENT

Every dry vent shall rise vertically to a minimum of 6 inches above the flood level rim of the highest trap or trapped fixture being served.

## 25.10 FIXTURE VENTS

### 25.10.1 DISTANCE OF TRAP FROM VENT

Each fixture vent shall have a protective vent located so that the slope and the developed length of the fixture drain from the trap weir to the vent fitting are within the requirements set forth in Table 26.1.

**Exception:** The developed length of the fixture drain from the trap weir to the vent fitting for self siphoning fixtures such as water closets shall not be limited.

Maximum distance of fixture trap from vent		
Size of trap (inches)	Slope	Distance from trap (feet)
1-1/4	1/4"	5
1-1/2	1/4"	6
2	1/4"	8
3	1/8"	12
4	1/8"	16

Table 25.1 - Maximum distance of fixture trap from vent

### 25.10.2 FIXTURE DRAINS

The total fall in a fixture drain resulting from pipe slope shall not exceed 1 pipe diameter, nor shall the vent pipe connection to a fixture drain, except for a water closet, be below the trap weir.

### 25.10.3 CROWN VENT

A vent shall not be installed within 2 pipe diameters of the trap weir.

## 25.11 TYPES OF VENTING METHODS

### 25.11.1 INDIVIDUAL VENT

Each trap and trapped fixture is permitted to be provided with an individual vent. The individual vent shall connect to the fixture drain of the trap or trapped fixture being vented.

**25.11.2 COMMON VENT**

A shared vent can be used for no more than 2 traps or trapped fixtures located on the same floor level. Where connected at the same level, the vent connection shall be at the interconnection of the fixture drain or downstream of the interconnection. Where the fixture drains connect at different levels, the vent shall connect as a vertical extension to the vertical drain. The vertical drain pipe connecting the two fixture drains shall be considered the vent for the lower fixture drain and shall be sized accordingly:

Common Vent Sizes	
Pipe size (inches)	Maximum discharge from upper fixture drain (dfu)
1 ½	1
2	4
2 ½ - 3	6

Table 25.2 - Common Vent Sizes

**25.11.3 WET VENTING****25.11.3.1 HORIZONTAL WET VENT PERMITTED**

Any combination of fixtures within two bathroom groups located on the same floor level is permitted to be vented by a horizontal wet vent. The wet vent shall be considered the vent for the fixtures and shall extend from the connection of the dry vent along the direction of flow in the drain pipe to the most downstream fixture drain connection. Each fixture drain shall connect horizontally to the horizontal branch being wet vented or shall have a dry vent. Only the fixtures within the bathroom group shall connect to the wet vented horizontal branch drain. Any additional fixtures shall discharge downstream of the horizontal wet vent.

**25.11.3.2 VENT CONNECTIONS**

The dry vent connection to the wet vent shall be an individual vent or common vent to the lavatory, bidet, shower stall or bath tub. In vertical wet vent systems, the most upstream fixture drain connection shall be a dry vented fixture drain connection. In horizontal wet vent systems, not more than one wet vented fixture drain shall discharge upstream of the dry vented fixture drain connection.

**25.11.3.3 SIZE**

Horizontal and vertical wet vents shall be of a minimum size as specified in Table 26.3 based on the fixture unit discharge into the wet vent. The dry vent serving the wet vent shall be sized based on the largest required diameter of pipe within the wet vent system served by the dry vent.

Wet Vent Size	
Wet Vent Pipe Size (inches)	Fixture Unit Load (dfu)
1-½	1
2	4
2-½	6
3	12
4	32

Table 25.3 - Wet Vent Size

**25.11.3.4 VERTICAL WET VENT PERMITTED**

A combination of fixtures located on the same floor level is permitted to be vented by a vertical wet vent. The vertical wet vent shall be considered the vent for the fixtures and shall extend from the connection of the dry vent down to the lowest fixture drain connection. Each wet vented fixture shall connect independently to the vertical wet vent. All water closet drains shall connect at the same elevation. Other fixture drains shall connect above or at the same level as the water closet fixture drains. The dry vent connection to the vertical wet vent shall be an individual or common vent serving one or two fixtures.

**25.11.3.5 TRAP WEIR TO WET VENT DISTANCES**

The maximum developed length of wet vented fixture drains shall comply with Table 26.1.

**25.11.4 WASTE STACK VENT****25.11.4.1 GENERAL**

A waste stack shall be considered for all the fixtures discharging to the stack where installed in accordance with the following:

- The waste stack shall be vertical and both horizontal and vertical offsets shall be prohibited between the lowest fixture drain connection and the highest fixture drain connection to the stack.
- Every fixture drain shall connect separately to the waste stack.
- The stack shall not receive the discharge of water closets or urinals.

**25.11.4.2 STACK VENT**

A stack vent shall be installed for the waste stack. The size of the stack vent shall not be less than the size of the waste stack. Offsets shall be permitted in the stack vent and shall be located at least 6 inches above the flood level rim of the highest fixture. The stack vent shall be permitted to connect to other stack vents and vent stacks.

**25.11.4.3 WASTE STACK SIZE**

The waste stack shall be sized based on the total discharge of the stack and the discharge within a branch interval in accordance with Table 26.4. The waste stack shall be the same size throughout the length of the waste stack.

<b>Waste Stack Vent Size</b>		
<b>Stack Size(inches)</b>	<b>Maximum number of fixture units (dfu)</b>	
	<b>Total discharge into 1 branch interval</b>	<b>Total discharge for stack</b>
1-½	1	2
2	2	4
2-½	No limit	8
3	No limit	24
4	No limit	50

Table 25.4 - Waste Stack Vent Size



### **25.11.5 CIRCUIT VENTING**

#### **25.11.5.1 GENERAL**

A maximum of eight fixtures connected to a horizontal branch drain shall be permitted to be circuit vented. Each fixture drain shall connect horizontally to the horizontal branch being circuit vented. The horizontal branch drain shall be classified as a vent from the most downstream fixture drain connection to the most upstream fixture drain connection to the horizontal branch.

#### **25.11.5.2 VENT CONNECTION**

The circuit vent connection shall be located between the two most upstream fixture drains. The vent shall connect to the horizontal branch and shall be in accordance with Section 26.6 – 26.9. The circuit vent pipe shall not receive the discharge of any soil or waste.

#### **25.11.5.3 SLOPE AND SIZE OF HORIZONTAL BRANCH**

The maximum slope of the vent section of the horizontal branch drain shall be one unit vertical in 12 units horizontal (8 percent slope). The entire length of the vent section of the horizontal branch drain shall be sized for the total drainage discharge to the branch in accordance with Table 25.4.

#### **25.11.5.4 ADDITIONAL FIXTURES**

Fixtures other than the circuit vented fixtures are permitted to discharge to the horizontal branch drain. Such fixtures shall be located on the same floor as the circuit vented fixtures and shall be either individually or common vented.

### **25.11.6 COMBINATION WASTE AND VENT SYSTEM**

#### **25.11.6.1 GENERAL**

A combination waste and vent system shall not serve fixtures other than floor drains, stand pipes, sinks, lavatories and drinking fountains. A combination waste and vent system shall not receive the discharge of a food waste grinder.

#### **25.11.6.2 INSTALLATION**

The only vertical pipe in a combination waste and vent system shall be the connection between the fixture drain and the horizontal combination waste and vent pipe. The maximum vertical distance shall be 8 feet.

#### **25.11.6.3 SLOPE**

The horizontal combination waste and vent pipe shall have a maximum slope of ½ unit vertical in 12 units horizontal (4 percent slope). The minimum slope shall be in accordance with Section 25.10.1.

#### **25.11.6.4 CONNECTION**

The combination waste and vent pipe shall connect to a horizontal drain that is vented or a vent shall connect to the combination waste and vent. The vent connecting to the combination waste and vent pipe shall extend vertically to a minimum of 6 inches above the flood level rim of the highest fixture being vented before offsetting horizontally.

#### **25.11.6.5 VENT SIZE**

The vent shall be sized for the total fixture unit load in accordance with Section 26.12.1

**25.11.6.6 FIXTURE BRANCH OR DRAIN**

The fixture branch or fixture drain shall connect to the combination waste and vent within a distance specified in Table 26.1. The combination waste and vent pipe shall be considered the vent for the fixture.

**25.11.6.7 SIZE**

The minimum size of a combination waste and vent pipe shall be in accordance with Table 26.5.

<b>Size of Combination Waste and Vent Pipe</b>		
<b>Diameter of Pipe (inches)</b>	<b>Maximum number of fixture units (dfu)</b>	
	<b>Connecting to a horizontal branch or stack</b>	<b>Connecting to a building drain or sub drain</b>
2	3	4
2-1/2	6	26
3	12	31
4	20	50

Table 25.5 - Size of Combination Waste and Vent Pipe

**25.11.7 ISLAND FIXTURE VENTING**

This venting system shall not be permitted for fixtures other than sinks (with or without food waste grinders or dishwashers) and lavatories.

**25.11.7.1 VENT CONNECTION**

The island fixture vent shall connect to the fixture drain as required for an individual or common vent. The vent shall rise vertically to above the drainage outlet of the fixture being vented before offsetting horizontally or vertically downward. The vent or branch vent for multiple island fixtures shall extend to a minimum of 6 inches above the highest island fixture being vented before connecting to the outside vent terminal.

**25.11.7.2 VENT INSTALLATION BELOW THE FIXTURE FLOOD LEVEL RIM**

The vent located below the flood level rim of the fixture being vented shall be installed as required for drainage piping contained in this Chapter. The vent shall be sized in accordance with Section 26.12.1. The lowest point of the island fixture vent shall be connected full size to the drainage system. The connection shall be to a vertical drain pipe or to the top half of a horizontal drain pipe. Cleanouts shall be provided in the island fixture vent to permit rodding of all vent piping located below the flood level rim of the fixtures. Rodding in both directions shall be permitted through a cleanout.

**25.12 VENT PIPE SIZING****25.12.1 SIZE OF VENTS**

The minimum required diameter of individual vents, branch vents, circuit vents, vent stacks and stack vents shall be at least one half the required diameter of the drain served. The required size of the drain pipe shall be determined in accordance with this Chapter. Vent pipes shall not be less than 1-1/4" in diameter. Vents exceeding 40 feet in developed length shall be increased by one nominal pipe size for the entire developed length of the vent pipe.

**25.12.2 DEVELOPED LENGTH**

The developed length of individual, branch and circuit vents shall be measured from the farthest point of vent connection to the drainage system to the point of connection to the vent stack, stack vent or termination outside the building.

**25.12.3 BRANCH VENTS**

Where branch vents are connected to a common branch vent, the common branch vent shall be sized in accordance with this section, based on the size of the common horizontal drainage branch that is or would be required to serve the total drainage fixture unit (dfu) load being vented.

**25.13 AIR ADMITTANCE VALVES****25.13.1 WHERE PERMITTED**

Individual air admittance valves shall be permitted and installed in accordance with this section.

**25.13.2 LOCATION**

Individual air admittance valves shall be located 4 inches above the fixture drain being vented.

**25.13.3 SIZE**

The air admittance valve shall be rated for the size of the vent to which the valve is connected.

**25.14 VENT REQUIRED**

Within each plumbing system, a minimum of one stack vent or vent stack shall extend outdoors to the open air.

**25.15 GRAY WATER RECYCLING SYSTEMS****25.15.1 PERMITTED**

Gray water recycling systems shall be permitted where they meet the requirements contained in Appendix C of the International Plumbing Code 2012.



## **26 CESSPITS**

---

### **26.1 GENERAL**

All grey and soil water shall be connected to a sewer or private sewage disposal system as directed by the Department of Health. Where cesspits are permitted, they shall be sited and constructed in accordance with this chapter.

### **26.2 PERMITS AND INSPECTIONS**

Where new cesspits are being constructed or existing ones are being altered or rebuilt, a permit shall be obtained from the Building Official. Prior to excavation, the setting out shall be inspected and approved by the Environmental Health Officer. After excavation is completed, the final determination of the required method of construction of the cesspit walls (as per Section 27.8) shall be at the discretion of the Building Official and will depend on site conditions. An inspection shall be requested prior to any construction commencing on the cesspit walls. The Environmental Health Officer shall be contacted to inspect the excavation of the cesspit to determine if suitable soil drainage will take place. In addition, the Environmental Health Officer shall be called upon final construction of the cesspit and all drainage piping shall be inspected prior to concealing/covering up.

### **26.3 DRAINAGE INTO CESSPITS**

Cesspits shall comprise of two compartments separated by a solid dividing wall: one compartment for the disposal of liquid waste from kitchen and laundry fixtures and the other for the disposal of drainage from bathroom fixtures. Storm water, outside shower drains and pool water shall not discharge into the cesspit.

### **26.4 SIZE**

Each cesspit compartment shall have a plan area of not less than 24 sq. feet and a depth of not less than 6 feet below the invert of the lowest sewer pipe for houses up to 4 bedrooms (144 cubic feet). Houses larger in size than this shall have the size of the pit increased proportionately, in accordance with the following formula:

**For each additional bedroom over four add an additional 6 square feet of plan area per compartment. (36 cubic feet per additional bedroom)**

### **26.5 LOCATION**

The cesspits shall be located as follows (NOTE: Distances are to be measured horizontally to the inside wall of the cesspit):

- a. 10 feet from a boundary line;
- b. 10 feet from the outside wall of a building including covered porches;
- c. 20 feet from the outside face of a potable water tank wall;
- d. 20 feet from the outside face of a swimming pool wall;
- e. 20 feet from a well;

- f. 10 feet from the edge of a road (Note: Cesspits adjacent to a public highway will be subject to review by the Highways Division of the Ministry of Public Works and more stringent requirements may be applied);
- g. 40 feet from the mean high water level and a minimum of 4 feet of natural ground between the floor of the cesspit and the mean high water level;
- h. In solid ground and not fill; and,
- i. Away from rock cut faces that extend below the level of the cesspit, where seepage may occur even though setback is satisfied. The allowable distance shall be at the discretion of the Department of Health.

**Exception:** A cesspit may be located closer than 20 feet from a water tank or pool provided that the top of the pit is below the bottom slab of the pool or tank.

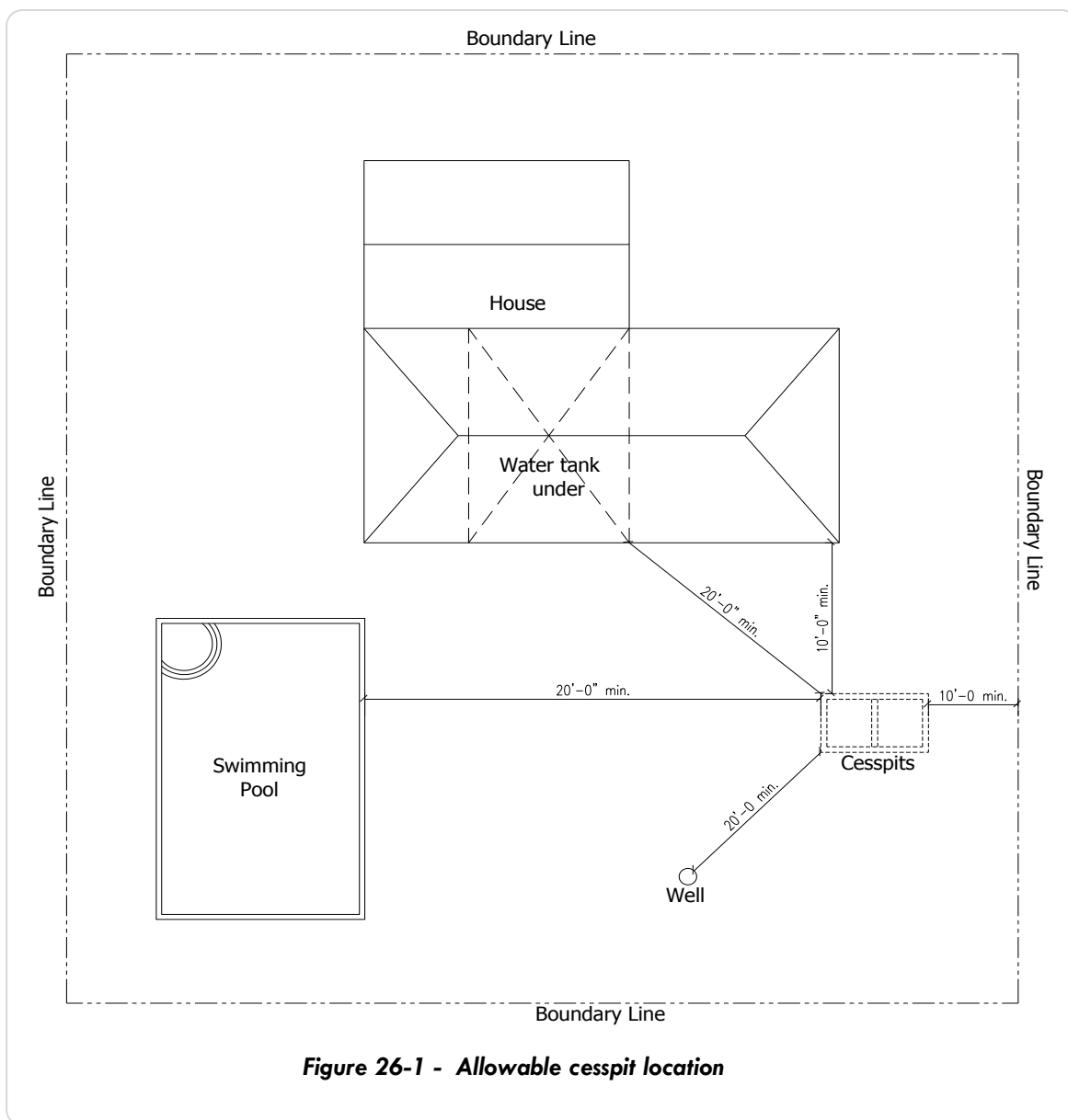

**Figure 26-1 - Allowable cesspit location**

**26.6 CESSPIT TOP SLABS**

Cesspits shall be provided with a concrete cover reinforced in accordance with Table 27.1 and 27.2. The cover to the reinforcing from the bottom of the slab shall be 2 inches. The slab shall extend 12 inches beyond the edge of the pit on all sides where the pit is constructed in sound rock with the sides unfaced. Where the walls of the cesspit are constructed with masonry in accordance with section 27.8, the slabs shall bear on the full width of the walls.

**26.7 ACCESS**

The concrete cover shall be provided with an access with a minimum clear opening of 18 inch x 18 inch centrally located in each chamber of the cesspit. The access cover shall be air tight and constructed of concrete or cast iron. Where cesspits are located more than 2 feet below finished grade, a 4 inch diameter pump out access pipe shall be cast in the slab and extended to grade level. A cleanout plug shall be provided and finished with a brass plate if located under hard surfacing.

**26.8 CESSPIT WALLS**

Where the walls are cut in sound hard rock, the sides of the cesspit may be left unfaced. Otherwise, the cesspit walls shall be constructed of 8 inch concrete masonry walls. The block cells shall be staggered 2 inches every 2<sup>nd</sup> masonry unit to provide weep holes to allow for the effective seepage of soil and waste water through the walls of the cesspit. The foundation of the walls shall be a minimum of 12 inches wide x 8 inches deep concrete.

**26.9 SEPTIC TANK WITH BOREHOLE OR SAND FILTER**

Any proposal to use this type of system in lieu of a cesspit shall require approval by the Department of Health and the Environmental Engineer.

**26.10 BACKFILLING BEHIND PITS**

The backfill behind a cesspit that has been constructed with block walls should be placed with course gravel immediately adjacent to the wall followed by a layer of sand then soil. The layers of gravel and sand should be a minimum of 6 inches in width.

Cesspit top construction 6" thick slab				
Bar Size	Maximum allowable span of slab for bar spacing of:			
	12 inch	10 inch	8 inch	6 inch
T 12	4 feet	4 feet 6 inches	5 feet 6 inches	6 feet 6 inches
T 16	6 feet	7 feet	8 feet	N/A

Table 26.1 - Cesspit top construction 6" thick slab

Cesspit top construction 8" thick slab				
Bar Size	Maximum allowable span of slab for bar spacing of:			
	12 inch	10 inch	8 inch	6 inch
T 12	6 feet 6 inches	7 feet	8 feet	9 feet 6 inches
T 16	8 feet	9 feet	10 feet	11 feet

Table 26.2 - Cesspit top construction 8" thick slab

**Notes:**

1. The reinforcing specified in Table 27.1 is the main span steel (short span) and shall be placed 2 inches from the bottom of the slab.
2. A minimum transverse distribution steel comprising of T 10 bars at 10 inch c/c for 6 inch slabs and T 12 bars at 12 inch c/c for 8 inch slabs shall be placed in the long span direction. This steel shall be placed on top of the main steel.
3. The reinforcing specified in the above tables will be sufficient to allow for the parking of passenger vehicles above the cesspits as well as temporary access of service vehicles, delivery trucks and the like over cesspits under driveways.

**26.11 PRECAST CONCRETE PITS**

The size of precast concrete cesspits shall meet the requirements of section 27.4 for the number of bedrooms served. Structural details of the pits shall be provided to the Building Official for their suitability under driveways and parking areas.

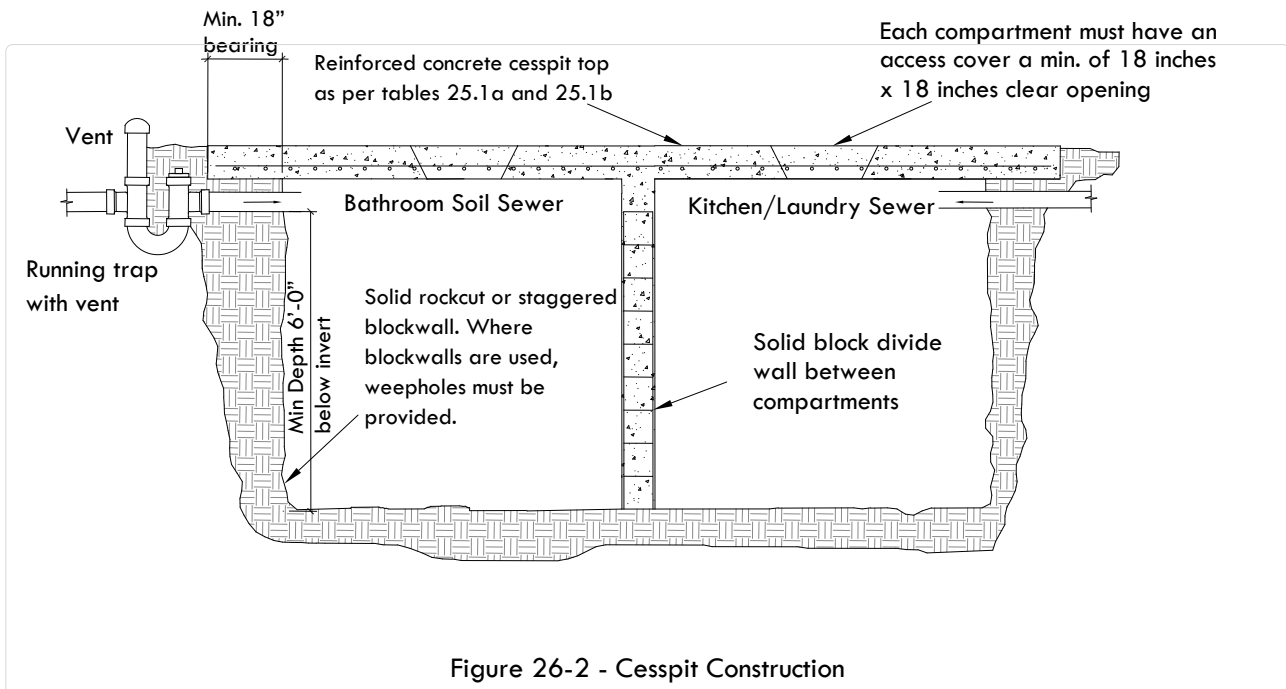

Figure 26-2 - Cesspit Construction



---

## **27 WATER SUPPLY & DISTRIBUTION**

---

### **27.1 GENERAL**

Dwelling units shall be supplied with potable water in the amounts and pressures specified in this chapter. In a building where both a potable and non potable water distribution system is installed, each system shall be identified by color marking, metal tag or other appropriate method. Any non potable outlet that could inadvertently be used for drinking or domestic purposes shall be posted.

### **27.2 WELLS**

Well water shall only be used to supply water closets, washing machines and outdoor hose bibs used for irrigation. The use of well water as potable water is prohibited unless the prior written approval of the Department of Health is obtained in writing. Water treatment systems such as reverse osmosis units or chlorination units are required to be licensed by the Environmental Authority and the Department of Health.

### **27.3 CROSS CONNECTIONS**

Connections shall not be made to a potable water supply in a manner that could contaminate the water supply or provide a cross connection between a supply and a source of contamination unless an approved backflow prevention device is provided. Private well connections to the potable water supply shall be provided with a backflow preventer with intermediate atmospheric vent to prevent well water from supplying the potable water system.

### **27.4 CONNECTIONS TO POTABLE MAINS WATER SUPPLIES**

Permission shall be obtained from the mains water provider to connect a private tank water system directly with their potable mains supply. An approved method of backflow prevention shall be used.

### **27.5 SOLAR WATER HEATING SYSTEMS**

The potable water supply to solar systems shall be equipped with a backflow preventer with intermediate atmospheric vent complying with ASSE 1012 or a reduced pressure principle backflow preventer complying with ASSE 1013. Where chemicals are used, the potable water supply shall be protected by a reduced pressure principle backflow preventer.

**Exceptions:** Where all solar system piping is part of the potable water distribution system and all components are listed for potable water use, cross connection protection measures shall not be required.

### **27.6 HOT WATER REQUIRED**

Hot water shall be supplied to kitchen sinks, lavatories, bath tubs, showers, laundry tubs and washing machines.

### **27.7 MINIMUM SIZE OF WATER SERVICE PIPE**

The minimum size of the water service pipe shall be  $\frac{3}{4}$  inches. The size of the water service mains, branch mains and risers shall be designed in accordance with the International Plumbing Code

2012 or other design methods conforming to acceptable engineering practice and approved by the Department of Health.

## **27.8 PRESSURE**

### **27.8.1 WATER SUPPLY SYSTEM DESIGN CRITERIA**

The water service and water distribution systems shall be designed and pipe sizes shall be selected such that under conditions of peak demand, each fixture is supplied with sufficient water pressure to operate as required without fluctuations that may impair performance.

### **27.8.2 BUILDING SUPPLY**

The minimum static pressure at the pump discharge shall be 20 psi for a single storey residence and 30 psi for a 2 storey building.

### **27.8.3 OUTLET DISCHARGE**

The minimum pressure at the point of outlet discharge shall not be less than 8 psi except where the fixture is designed to operate at a higher pressure.

## **27.9 FIXTURE WATER SUPPLY PIPES**

The minimum size of fixture water supply pipes shall be in accordance with Table 28.1.

Minimum Size of Water Supply Pipes for Plumbing Fixtures	
Plumbing Fixture	Minimum Pipe Size
Bathtub	1/2 inch
Bidet	3/8 inch
Dishwasher	1/2 inch
Hose Bibs	1/2 inch
Kitchen Sink	1/2 inch
Lavatory	3/8 inch
Sink	1/2 inch
Shower	1/2 inch
Washing Machine	1/2 inch
Water Closet	3/8 inch

Table 27.1 - Minimum Size of Water Supply Pipes for Plumbing Fixtures

## **27.10 MAXIMUM FLOW**

All water outlets shall restrict the flow rate to a maximum of 2.5 gallons per minute at 80 psi. Water closets should use a maximum of 1.6 gallons per flush.

## **27.11 VALVES**

Shut off valves shall be provided at each fixture supplied with water in a building. An accessible main shut off valve located near the pump discharge shall be provided for each dwelling unit.

**27.12 TRENCHING**

Trenching, pipe installation and backfilling shall be in accordance with the provisions of Sections 24.5.1 and 24.5.2. Water service pipe is permitted to be located in the same trench with a building sewer provided such sewer is constructed of materials approved for underground drainage provided in Section 25.12.1. If the buildings sewer pipe is constructed of vitrified clay, copper or copper alloy as listed in Table 25.1, then the water service pipe shall be separated from the building sewer by a minimum of 5 feet measured horizontally of undisturbed or compacted earth or placed on a solid ledge of at least 12 inches above and to one side of the highest point of the sewer line.

**27.13 APPROVED WATER SERVICE AND DISTRIBUTION PIPE MATERIALS**

All water supply and distribution pipes shall be non corrosive, lead free (<8% lead content) and shall conform to the relevant ASTM standards. The water pipe shall have a minimum pressure rating of 100psi at 180 degrees F. The following materials listed in Table 26.2 may be used for water supply and distribution:

Water Service & Distribution Piping	
Material	Referenced Standard
Copper or Copper Alloy	ASTM B42, ASTM B302
CPVC (Chlorinated polyvinyl chloride)	ASTM D2846, ASTM F441, ASTM F442
PVC Schedule 40	ASTM D1785, ASTM D2241, ASTM D2672
Brass	ASTM B43

Table 27.2 - Water Service &amp; Distribution Piping

**27.14 SOLVENT CEMENT PRIMER**

All joints must be primed with purple colored primer conforming to ASTM 656 immediately prior to cementing PVC and CPVC pipe and fittings.

**27.15 TESTING**

The entire water distribution system must pass testing requirements contained in Section 24.3.1.

**27.16 FLUSHING AND DISINFECTION OF THE POTABLE WATER SYSTEM**

Prior to occupancy, the entire water distribution system shall be flushed with potable water to remove debris, stagnant water and solvent odours. The water shall be free of objectionable smells. Disinfection of the water system is strongly recommended and can be achieved by adding 3 or 4 oz of 5.25% unscented household bleach per 1000 gallons of water which should provide a residual of 1 part per million. The tank must be clean and the water clear and free of suspended solids for maximum effect. Mix the chlorine well by agitating the water with a bucket and rope. Bleed all outlets until a chlorine scent is detected and let stand for at least 24 hours.

**27.17 WATER HEATERS****27.17.1 SEPARATE DWELLING UNITS**

Each separate dwelling unit shall have its own water heater that supplies only the fixtures within the unit.

**27.17.2 PRESSURE**

Tanks shall be rated for a minimum pressure of 125psi.

**27.17.3 WATER HEATER VALVE**

A readily accessible fullway valve shall be installed on the cold supply pipe to each water heater at or near the water heater.

**27.17.4 RELIEF VALVES**

All water heaters shall be protected with temperature and temperature pressure relief valves. Temperature relief valves shall be set at a maximum of 210 degrees F. Pressure relief valves shall be set a maximum of the pressure rating of the water heater or 150psi, whichever is less.

**27.17.5 REQUIREMENTS FOR DISCHARGE PIPE**

The discharge piping serving a pressure relief valve, temperature relief valve or combination valve shall:

1. Not be directly connected to the drainage system.
2. Discharge through an air gap located in the same room as the water heater.
3. Not be smaller than the diameter of the outlet of the valve served and shall discharge full size to the air gap.
4. Serve a single relief device and shall not connect to piping serving any other relief valve.
5. Discharge to the floor, to an indirect waste receptor or to the outdoors.
6. Discharge in a manner that does not cause personal injury or structural damage.
7. Discharge to a termination point readily observable by the building occupants.
8. Not be trapped.
9. Be installed to flow by gravity.
10. Not terminate more than 6 inches above the floor or waste receptor.
11. Not have a threaded connection at the end of the piping.
12. Not have valves or tee fittings.
13. Be constructed of copper, CPVC or galvanized steel.

**27.17.6 LABELING**

All water heaters shall bear the label of an approved agency. The maximum allowable working pressure shall be clearly marked.

**27.17.7 LOCATION**

Water heaters shall be located and connected so as to provide access for maintenance, servicing and replacement.

**27.17.8 TEMPERATURE CONTROLS**

All water heaters shall be equipped with automatic temperature controls capable of adjustment.

**27.17.9 INSTALLATION**

Water heaters shall be installed in accordance with the manufacturer's installation instructions and in accordance with the National Electric Code.

Sizing of Water Heaters (US gallons)					
Number of Bathrooms	Number of Bedrooms				
	1	2	3	4	5 or more
1 – 1 ½	20	20	30	40	40
2 to 2 ½	20	30	40	40	50
3 or more	30	40	50	50	60

**27.17.10 GAS FIRED WATER HEATER**

Gas fired water heaters shall comply with the requirements of the Bermuda Electrical Code and be installed strictly in accordance with the manufacturer's installation instructions.

**27.17.10.1 SIZE**

The minimum size of water heaters shall be in accordance with Table 28.3.

Table 27.3 - Sizing of Water Heaters (US gallons)



## 28 WATER TANKS

### 28.1 GENERAL

Water storage shall be in accordance with the Public Health Act 1949 and the Public Health (Water Storage) Regulations 1951 and any subsequent amendments.

### 28.2 CATCHMENT

A roof must have at least four fifths of its area adequately guttered to catch rain water.

### 28.3 MINIMUM DEPTH

A potable water tank shall not be less than 4 feet in depth measured internally.

### 28.4 HEIGHT ABOVE GROUND WATER

The bottom slab of the tank shall be at least 2 feet above the mean high water level.

### 28.5 STORAGE CAPACITY

The size of the tank (in imperial gallons) shall be such that it can contain at least 8 times the plan roof area (in sq. feet) between the floor of the tank (excluding the sump) and the lowest level of overflow discharge. [To calculate the required size of the water tank in cubic feet, note that 1 cubic foot equals 6.25 imperial gallons]



### 28.6 DRAINAGE PIPES ABOVE WATER TANKS OR POTABLE WATER COLLECTION AREAS

No soil, waste, vent or drainage pipe shall be positioned so as to run through, over or on top of any water storage tank or potable water collection area.

**Exception:** Where soil or waste drain pipes are installed in blockwork walls that are situated around the perimeter of a water tank, the pipe shall exit the wall a minimum of 2 feet above the tank top. The block wall must be solid filled with concrete to a height of 2 feet above the tank top, for a horizontal distance of at least 2 feet either side of the drain pipe.

**28.7**      **ACCESS**

Tanks shall be provided with an opening not less than 18in x 24in in area. The access hatch shall be of galvanised or cast iron and shall be water tight. Access hatches shall be raised above grade and located so as to exclude surface run off.

**28.8**      **VENTILATION**

Any ventilation openings to the tank space shall be screened to prevent the entry of insects.

**28.9**      **OVERFLOW**

A suitable overflow shall be provided that discharges water onto the owner's property and in such a manner as to not cause any dampness problems with any dwelling unit. The overflow shall be a 4" minimum internal diameter pipe and shall discharge water beyond the wall line of the building. The overflow shall not cause any nuisance to a neighboring property. The opening to the tank space shall be screened to prevent the entry of insects. The overflow shall be placed a sufficient height above the ground to prevent any surface water entering the tank. Where it is not possible to locate a tank overflow pipe above grade, it shall be directed to a soakaway pit of suitable size. The soakaway pit shall be used only for the overflow of tank water and the inlet pipe shall be fitted with a backwater valve.

**28.10**     **SEPARATION OF POTABLE WATER TANKS**

A potable water tank shall not share a common wall with any tank containing non potable water.

**28.11**     **SEPARATE TANKS REQUIRED**

Each independently owned dwelling unit shall have its own water tank.

**Exception:** Independently owned dwelling units shall be permitted to share a tank where it is not structurally feasible to construct independent water tanks, and:

- a. a supplemental water supply is provided, and,
- b. each unit's potable water supply is separately metered.

**28.12**     **APARTMENT HOUSE DEVELOPMENTS**

Every dwelling unit in an apartment house shall be provided with a water meter that is readily accessible.

**Exception:** Water meters are not required where the owner occupies a dwelling unit in an apartment house consisting of no more than 2 units.

**28.13**     **METAL DECKS PROHIBITED OVER TANKS**

Metal deck floor systems shall not be used over water tanks.

**28.14**     **CONSTRUCTION OF WATER TANKS****28.14.1**    **SLABS**

The concrete slab for the water tank shall be laid in sound hard foundation material as described in Chapter 6. The slab shall be a minimum of 6 inches thick and reinforced with A98 if found on rock



or A193 mesh if founded on sand. The edges of the slab shall be thickened and reinforced to comply with the requirements of Table 6.1. The slab shall be sloped to a sump.

**28.14.2 SUMPS**

A sump shall be constructed in each water tank compartment to enable the tank to be cleaned out. The minimum size of the sumps shall be 2 feet x 2 feet x 6 inches deep. The sump shall as far as practical be located under the tank access and the floor of the tank shall be sloped towards the sump.

**28.14.3 DIVIDING WALL**

Each water tank shall have at least one dividing wall to allow an uninterrupted water supply while the tank is being cleaned.

**Exception:** A dividing wall is not required for dwellings with more than one potable water tank.

**28.14.4 TANK WALLS**

**28.14.4.1 GENERAL**

The walls shall be constructed of concrete masonry, solid filled and plastered to prevent leaks.

**28.14.4.2 IN GROUND WATER TANKS**

The walls for in ground water tanks up to 12 feet in height shall be constructed of a minimum of 10 inch blockwork. Once the walls and the floor over them have been constructed, the excavation around the walls shall be backfilled with a minimum of 1500PSI concrete, between the rockcut and the tank walls. Alternatively, tanks may be constructed with a minimum of 12 inch thick walls of rubble concrete where the cuts surrounding the tank are in sound hard rock.

**28.14.4.3 OUT OF GROUND WATER TANKS**

Where the wall of the water tank is unsupported soil it shall be constructed in accordance with Table 29.1. For heights over 7 feet, design by a registered engineer will be required.

**28.14.4.4 PLASTERING/RENDERING OF TANK WALL**

The inside of the water tank shall receive a minimum ¾ inch of plaster. The plaster coating shall be applied in a continuous operation around the entire tank walls. The plaster shall be proportioned to 1 part cement: 2 parts sand.

**28.14.4.5 WATERPROOF COATINGS**

The plastered walls shall receive a coating of cement wash. Any additional coating of material that the applicant wishes to apply to the inside of the water tank shall be compatible for use with potable water and shall be subject to the approval by the Department of Health.

Above Ground Water Tank Wall Construction		
Height of Wall	10" Hollow Block Reinforced	12" Hollow Block Reinforced
Up to 4 feet	T 12 @ 48 inches c/c	T 12 @ 48 inches c/c
5 feet	T 12 @ 32 inches c/c	T 12 @ 32 inches c/c
6 feet	T 16 @ 32 inches c/c	T 16 @ 24 inches c/c
7 feet	N/A	T 16 @ 24 inches c/c

Table 28.1 - Above Ground Water Tank Wall Construction

**Notes:**

1. The wall height referred to is the distance that the water tank is above grade level measured to the underside of the floor over the water tank.
2. With reinforced masonry the bars shall be placed vertically in the center of the cells. The reinforcing shall be turned a minimum of 24 inches into the slab below and 18 inches into the slab above. Minimum lap length of the reinforcing bars shall be in accordance with Table 13.2.
3. This table is only applicable when the floor over the water tank is constructed of a concrete slab.
4. All cells of the masonry walls shall be solid filled with concrete.
5. N/A means not applicable.
6. For the alternative imperial reinforcing sizes to the metric sizes shown in the table, see Table 13.3.
7. For above ground heights above 7 feet, a registered engineer shall be consulted.

**28.15      SAFETY OF WATER TANK EXCAVATIONS**

All excavations for water tanks shall be kept covered at all times until the permanent flooring has been installed over them. The covers shall be suitable to withstand a minimum point load of 300 lb. Alternatively a barrier in accordance with Section 34.1 shall be erected to totally enclose the tank excavation and prevent accidental falls.

**28.16      PREVENTION OF STANDING WATER**

No standing water shall be allowed to accumulate in partially finished water tanks due to the potential occurrence of mosquito breeding.

**28.17      NON CONCRETE WATER TANKS**

Potable water tanks that are constructed of material other than concrete must be approved by the Department of Health.

## 29 RAINWATER DRAINAGE

### 29.1 GENERAL

A roof must have at least four fifths of its roof adequately guttered to catch rain water. Roofs shall be installed with gutter stones or glides to direct the rainwater to drain pipes.

### 29.2 STRAINERS

Roof drains should have strainers extending not less than 4 inches above the surface of the roof.

### 29.3 SIZE OF RAINWATER PIPES

The size of these drains shall be based on the maximum projected roof area in accordance with Tables 30.1 and 30.2. The rainfall intensity for Bermuda used to size these drains is 5 inches per hour based on a 100 year return period. The minimum size for underground rainwater piping shall be 3 inches internal diameter.

Size of Vertical Rainwater Leaders	
Internal Size of Piping	Maximum Horizontally Projected Roof Area (sq. ft)
2 inch	575
3 inch	1760
4 inch	3680

Table 29.1 - Size of Vertical Rainwater Leaders

Size of Horizontal Rainwater Drains			
Internal Size of Piping	Maximum Horizontally Projected Roof Area (sq. ft.)		
	Slope 1/8 inch to 1 foot	Slope 1/4 inch to 1 foot	Slope 1/2 inch to 1 foot
3 inch	657	928	1310
4 inch	1504	2120	3010
5 inch	2672	3776	5320
6 inch	4280	6040	8580

Table 29.2 - Size of Horizontal Rainwater Drains

### 29.4 VERTICAL WALLS

In sizing roof drains, one half of the area of any vertical walls which can divert rainwater onto the roof shall be added to the projected roof area for inclusion in calculating the required size of piping.

### 29.5 DRAINAGE

Rainwater shall discharge into the water tank unless otherwise approved by the Building Official in which case the discharge of water shall be contained entirely on the owner's property. Rainwater drainage shall not be directed to a cesspit. Separate drainage soakaway pits to the sizes referred to in Section 5.14.3 shall be used.

**29.6**      **EQUIPMENT ON ROOF**

All air conditioners or other forms of mechanical equipment mounted on the roof shall be isolated from the potable water catchment.

**29.7**      **EXHAUSTS**

No kitchen or dryer exhaust ducts shall terminate above a potable water roof catchment.

---

## **30 PLUMBING FIXTURES**

---

### **30.1 GENERAL**

Plumbing fixtures and fittings shall be constructed of approved materials with smooth, impervious surfaces free from defects and concealed fouling surfaces.

### **30.2 INSTALLATION**

The installation of fixtures shall conform to the following:

- a. Floor outlet or floor mounted fixtures shall be secured to the drainage connection and to the floor by screws or bolts of corrosion resistant material.
- b. Wall hung fixtures shall be rigidly supported so that the strain is not transmitted to the plumbing system. Joints formed where fixtures come in contact with walls or floors shall be water tight.
- c. Plumbing fixtures shall be installed so as to afford easy access for cleaning both the fixture and the area around it.
- d. Where practical, all piping, fixtures or equipment shall not interfere with the operation of doors or windows.

### **30.3 WATER CLOSETS, URINALS, LAVATORIES AND BIDETS**

A water closet, urinal, lavatory or bidet shall not be set closer than 15 inches from its center to any side wall, partition, vanity or other obstruction, or closer than 30 inches center-to-center between adjacent fixtures. There shall be at least a 21-inch clearance in front of the water closet, urinal, lavatory or bidet to any wall, fixture or door.

### **30.4 SHOWER RECEPTORS**

#### **30.4.1 SIZE**

All shower compartments shall have a minimum of 900 sq. inches (6.25 sq. ft.) and the minimum dimension shall be not less than 30" measured from the interior of the shower exclusive of fixture valves, shower heads, soap dishes and safety grab bars.

#### **30.4.2 CONSTRUCTION**

The curb shall not be less than 2 inches or more than 9 inches in depth measured from the top of the curb to the top of the drain. The finished floor shall slope uniformly toward the drain with a gradient of not less than ¼ inch to 1 foot, nor more than ½ inch to 1 foot. Floor drains shall be flanged to provide a water tight joint in the floor.

#### **30.4.3 WALL LINING**

Shower walls shall be finished with a smooth, hard and non absorbent surface that shall extend a minimum of not less than 6 feet above the floor. Such walls shall form a water tight joint with each other and the bath tub, receptor or shower floor.

**30.5      HOT WATER SUPPLY**

Faucets and taps shall be installed so that the flow of hot water from the fittings corresponds to the left hand side as a person faces the fixture.

**30.6      PROTECTION OF POTABLE WATER SUPPLY****30.6.1      AIR GAPS**

The supply lines of plumbing fixtures shall be installed so as to prevent backflow by the use of an air gap between the opening and the flood level of the fixture equal to 2 times the effective opening diameter of the water supply outlet.

**Exception:** If an outlet is located closer than 4 times the diameter of the opening to a wall or other obstruction, the air gap shall be 3 times the effective opening diameter.

**30.6.2      HOSE CONNECTIONS**

A minimum of one outside hose bib shall be supplied per separately owned dwelling unit. Hose bibs and other openings with a hose connection shall be protected by an atmospheric type or pressure type vacuum breaker or a permanently attached hose connection vacuum breaker.

---

## **31 ENERGY EFFICIENCY**

---

### **31.1 SCOPE AND ADMINISTRATION**

#### **31.1.1 INTENT**

This chapter shall regulate the design and construction of buildings for the effective use and conservation of energy over the useful life of each building. This chapter is intended to provide flexibility to permit the use of innovative approaches and techniques to achieve this objective. This chapter is not intended to abridge safety, health or environmental requirements contained in other chapters of this code.

#### **31.1.2 APPLICABILITY**

##### **31.1.2.1 EXISTING BUILDINGS**

Except as specified in this chapter, this code shall not be used to require the removal, alteration or abandonment of, nor prevent the continued use and maintenance of, an existing building or building system lawfully in existence at the time of adoption of this code.

##### **31.1.2.2 ADDITION, ALTERATIONS, RENOVATIONS OR REPAIRS**

Additions, alterations, renovations or repairs to an existing building, building system or portion thereof shall conform to the provisions of this chapter as they relate to new construction without requiring the unaltered portion(s) of the existing building or building system to comply with this chapter. Additions, alterations, renovations or repairs shall not create an unsafe or hazardous condition or overload existing building systems. An addition shall be deemed to comply with this code if the addition alone complies or if the existing building and addition comply with this chapter as a single building.

Exception: The following need not comply provided the energy use of the building is not increased:

- Storm windows installed over existing fenestration.
- Glass only replacements in an existing sash or frame.
- Construction where the existing roof, wall or floor cavity is not exposed.
- Alterations that replace less than 50 percent of the luminaires in a space provided that such alterations do not increase the installed interior lighting power.
- Alterations that replace only the bulb and ballast within the existing luminaires in a space provided the alteration does not increase the installed interior lighting power.

##### **31.1.2.3 CHANGE IN OCCUPANCY OR USE**

Spaces undergoing a change in occupancy that would result in an increase in demand for either fossil fuel or electrical energy shall comply with this chapter.

##### **31.1.2.4 CHANGE IN SPACE CONDITIONING**

Any nonconditioned space that is altered to become conditioned space shall be required to be brought into full compliance with this chapter.

#### **31.1.3 COMPLIANCE**

All residential buildings shall meet the provisions of this chapter.

## 31.2 DEFINITIONS

**Above-grade wall.** A wall more than 50 percent above grade and enclosing *conditioned space*. This includes between-floor spandrels, peripheral edges of floors, roof and basement knee walls, dormer walls, gable end walls, walls enclosing a mansard roof and skylight shafts.

**Accessible.** Admitting close approach as a result of not being guarded by locked doors, elevation or other effective means (see "Readily *accessible*").

**Addition.** An extension or increase in the *conditioned space* floor area or height of a building or structure.

**Air barrier.** Material(s) assembled and joined together to provide a barrier to air leakage through the building envelope. An air barrier may be a single material or a combination of materials.

**Alteration.** Any construction or renovation to an existing structure other than repair or addition that requires a permit. Also, a change in a mechanical system that involves an extension, addition or change to the arrangement, type or purpose of the original installation that requires a permit.

**Approved.** Approval by the *code official* as a result of investigation and tests conducted by him or her, or by reason of accepted principles or tests by nationally recognized organizations.

**Automatic.** Self-acting, operating by its own mechanism when actuated by some impersonal influence, as, for example, a change in current strength, pressure, temperature or mechanical configuration (see "Manual").

**Basement wall.** A wall 50 percent or more below grade and enclosing *conditioned space*.

**Building.** Any structure used or intended for supporting or sheltering any use or occupancy, including any mechanical systems, service water heating systems and electric power and lighting systems located on the building site and supporting the building.

**Building site.** A contiguous area of land that is under the ownership or control of one entity.

**Building thermal envelope.** The basement walls, exterior walls, floor, roof, and any other building elements that enclose *conditioned space* or provides a boundary between *conditioned space* and exempt or unconditioned space.

**C-Factor (thermal conductance).** The coefficient of heat transmission (surface to surface) through a building component or assembly, equal to the time rate of heat flow per unit area and the unit temperature difference between the warm side and cold side surfaces (Btu/h ft<sup>2</sup> × °F) [W/(m<sup>2</sup> × K)].

**Code Official.** The *Building Official*

**Conditioned floor area.** The horizontal projection of the floors associated with the *conditioned space*.

**Conditioned space.** An area or room within a building being heated or cooled, containing uninsulated ducts, or with a fixed opening directly into an adjacent *conditioned space*.



**Continuous air barrier.** A combination of materials and assemblies that restrict or prevent the passage of air through the building thermal envelope.

**Crawl space wall.** The opaque portion of a wall that encloses a crawl space and is partially or totally below grade.

**Curtain wall.** Fenestration products used to create an external nonload-bearing wall that is designed to separate the exterior and interior environments.

**Demand recirculation water system.** A water distribution system where pump(s) prime the service hot water piping with heated water upon demand for hot water.

**Duct.** A tube or conduit utilized for conveying air. The air passages of self-contained systems are not to be construed as air ducts.

**Duct system.** A continuous passageway for the transmission of air that, in addition to ducts, includes duct fittings, dampers, plenums, fans and accessory air-handling equipment and appliances.

**Dwelling unit.** A single unit providing complete independent living facilities for one or more persons, including permanent provisions for living, sleeping, eating, cooking and sanitation.

**Energy analysis.** A method for estimating the annual energy use of the *proposed design* and *standard reference design* based on estimates of energy use.

**Energy cost.** The total estimated annual cost for purchased energy for the building functions regulated by this code, including applicable demand charges.

**Energy simulation tool.** An *approved* software program or calculation-based methodology that projects the annual energy use of a building.

**Entrance door.** Fenestration products used for ingress, egress and access in nonresidential buildings, including, but not limited to, exterior entrances that utilize latching hardware and automatic closers and contain over 50-percent glass specifically designed to withstand heavy use and possibly abuse.

**Exterior wall.** Walls including both above-grade walls and basement walls.

**Fenestration.** Skylights, roof windows, vertical windows (fixed or moveable), opaque doors, glazed doors, glazed block and combination opaque/glazed doors. Fenestration includes products with glass and nonglass glazing materials.

**Fenestration product, site-built.** A fenestration designed to be made up of field glazed or field-assembled units using specific factory cut or otherwise factory-formed framing and glazing units. Examples of site-built fenestration include storefront systems, curtain walls, and atrium roof systems.

**F-Factor.** The perimeter heat loss factor for slab-on-grade floors (Btu/h × ft × °F) [W/(m × K)].

**Heated slab.** Slab-on-grade construction in which the heating elements, hydronic tubing, or hot air distribution system is in contact with, or placed within or under, the slab.

**High-efficacy lamps.** Compact fluorescent lamps, t-8 or smaller diameter linear fluorescent lamps, or lamps with a minimum efficacy of:

1. 60 lumens per watt for lamps over 40 watts;
2. 50 lumens per watt for lamps over 15 watts to 40 watts; and
3. 40 lumens per watt for lamps 15 watts or less.

**Infiltration.** The uncontrolled inward air leakage into a building caused by the pressure effects of wind or the effect of differences in the indoor and outdoor air density or both.

**Insulating sheathing.** An insulating board with a core material having a minimum *r* value of *r*-2.

**Labeled.** Equipment, materials or products to which have been affixed a label, seal, symbol or other identifying mark of a nationally recognized testing laboratory, inspection agency or other organization concerned with product evaluation that maintains periodic inspection of the production of the above-labeled items and whose labeling indicates either that the equipment, material or product meets identified standards or has been tested and found suitable for a specified purpose.

**Listed.** Equipment, materials, products or services included in a list published by an organization acceptable to the *code official* and concerned with evaluation of products or services that maintains periodic inspection of production of *listed* equipment or materials or periodic evaluation of services and whose listing states either that the equipment, material, product or service meets identified standards or has been tested and found suitable for a specified purpose.

**Low-voltage lighting.** Lighting equipment powered through a transformer such as a cable conductor, a rail conductor and track lighting.

**Manual.** Capable of being operated by personal intervention (see "automatic").

**Proposed design.** A description of the proposed building used to estimate annual energy use for determining compliance based on total building performance.

**Readily accessible.** Capable of being reached quickly for operation, renewal or inspection without requiring those to whom ready access is requisite to climb over or remove obstacles or to resort to portable ladders or access equipment (see "*accessible*").

**Repair.** The reconstruction or renewal of any part of an existing building.

**Roof assembly.** A system designed to provide weather protection and resistance to design loads. The system consists of a roof covering and roof deck or a single component serving as both the roof covering and the roof deck. A roof assembly includes the roof covering, underlayment, roof deck, insulation, vapor retarder and interior finish.

**R-value (thermal resistance).** The inverse of the time rate of heat flow through a body from one of its bounding surfaces to the other surface for a unit temperature difference between the two surfaces, under steady state conditions, per unit area ( $h \cdot \text{ft}^2 \cdot ^\circ\text{f}/\text{btu}$ ) [ $(\text{m}^2 \cdot \text{k})/\text{w}$ ].

**Service water heating.** Supply of hot water for purposes other than comfort heating.

**Skylight.** Glass or other transparent or translucent glazing material installed at a slope of less than 60 degrees (1.05 rad) from horizontal. Glazing material in skylights, including unit skylights, solariums, sunrooms, roofs and sloped walls is included in this definition.

**Solar heat gain coefficient (shgc).** The ratio of the solar heat gain entering the space through the fenestration assembly to the incident solar radiation. Solar heat gain includes directly transmitted solar heat and absorbed solar radiation which is then reradiated, conducted or convected into the space.

**Standard reference design.** A version of the *proposed design* that meets the minimum requirements of this code and is used to determine the maximum annual energy use requirement for compliance based on total building performance.

**Sunroom.** A one-story structure attached to a dwelling with a glazing area in excess of 40 percent of the gross area of the structure's exterior walls and roof.

**Thermal isolation.** Physical and space conditioning separation from *conditioned space(s)*. The *conditioned space(s)* shall be controlled as separate zones for heating and cooling or conditioned by separate equipment.

**Thermostat.** An automatic control device used to maintain temperature at a fixed or adjustable set point.

**U-Factor (thermal transmittance).** The coefficient of heat transmission (air to air) through a building component or assembly, equal to the time rate of heat flow per unit area and unit temperature difference between the warm side and cold side air films (Btu/h • ft<sup>2</sup> • °F) [W/(m<sup>2</sup> • K)].

**Ventilation.** The natural or mechanical process of supplying conditioned or unconditioned air to, or removing such air from, any space.

**Ventilation air.** That portion of supply air that comes from outside (outdoors) plus any recirculated air that has been treated to maintain the desired quality of air within a designated space.

**Visible Transmittance [VT].** The ratio of visible light entering the space through the fenestration product assembly to the incident visible light, Visible Transmittance, includes the effects of glazing material and frame and is expressed as a number between 0 and 1.

**Whole house mechanical ventilation system.** An exhaust system, supply system, or combination thereof that is designed to mechanically exchange indoor air with outdoor air when operating continuously or through a programmed intermittent schedule to satisfy the whole house ventilation rates.

**Zone.** A space or group of spaces within a building with heating or cooling requirements that are sufficiently similar so that desired conditions can be maintained throughout using a single controlling device.

### **31.3 GENERAL REQUIREMENTS**

#### **31.3.1 CLIMATE ZONE**

The climate zone for Bermuda is 2A, as specified in the International Energy Conservation Code (IECC).

### **31.4 BUILDING THERMAL ENVELOPE**

#### **31.4.1 GLAZED FENESTRATION**

All new fenestration with an area-weighted average of more than 50-percent glazed shall have a maximum solar heat gain coefficient (SHGC) of 0.25.

Exception:

- Glazed skylight fenestration must have a maximum SHGC of 0.30.

##### **31.4.1.1 REPLACEMENT FENESTRATION**

Where some or all of an existing fenestration unit is replaced with a new fenestration product, including sash or glazing, the replacement fenestration unit shall meet the applicable SHGC requirement.

### **31.5 SYSTEMS**

#### **31.5.1 CONTROLS**

At least one thermostat shall be provided for each separate heating and cooling system.

##### **31.5.1.1 PROGRAMMABLE THERMOSTAT**

For each building-integrated split or central air conditioning system, the corresponding thermostat shall be capable of controlling the cooling system on a daily schedule to maintain different temperature set points at different times of the day. When technically impractical, ordinary thermostats shall be permitted.

#### **31.5.2 DUCTS**

##### **31.5.2.1 INSULATION**

Supply ducts in attics shall be insulated to a minimum of R-8. All other ducts shall be insulated to a minimum of R-6.

Exception: Ducts or portions thereof located completely inside the *building thermal envelope*.

##### **31.5.2.2 SEALING**

Ducts, air handlers, and filter boxes shall be sealed. Joints and seams shall comply with either the *International Mechanical Code* or *International Residential Code*, as applicable.

Exceptions:

- Air-impermeable spray foam products shall be permitted to be applied without additional joint seals.
- Where a duct connection is made that is partially inaccessible, three screws or rivets shall be equally spaced on the exposed portion of the joint so as to prevent a hinge effect.

- Continuously welded and locking-type longitudinal joints and seams in ducts operating at static pressures less than 2 inches of water column (500 Pa) pressure classification shall not require additional closure systems.

**31.5.3 MECHANICAL SYSTEM PIPING INSULATION**

Mechanical system piping capable of carrying fluids above 105°F (41°C) or below 55°F (13°C) shall be insulated to a minimum of R-3.

**31.5.3.1 PROTECTION OF PIPING INSULATION.**

Piping insulation exposed to weather shall be protected from damage, including that caused by sunlight, moisture, equipment maintenance, and wind, and shall provide shielding from solar radiation that can cause degradation of the material. Adhesive tape shall not be permitted.

**31.5.4 SERVICE HOT WATER SYSTEMS.**

Energy conservation measures for service hot water systems shall be in accordance with Sections 32.5.4.1 and 32.5.4.2.

**31.5.4.1 CIRCULATING HOT WATER SYSTEMS**

Circulating hot water systems shall be provided with an automatic or readily *accessible* manual switch that can turn off the hot-water circulating pump when the system is not in use.

**31.5.4.2 HOT WATER PIPE INSULATION**

Insulation for hot water pipe with a minimum thermal resistance (*R*-value) of R-3 shall be applied to the following:

- Piping larger than 3/4 inch nominal diameter.
- Piping serving more than one dwelling unit.
- Piping from the water heater to kitchen outlets.
- Piping located outside the conditioned space.
- Piping from the water heater to a distribution manifold.
- Piping located under a floor slab.
- Buried piping.
- Supply and return piping in recirculation systems other than demand recirculation systems.
- Piping with run lengths greater than the maximum run lengths for the nominal pipe diameter given in Table 33.1.

All remaining piping shall be insulated to at least R-3 or meet the run length requirements of Table 32.1.

Nominal Pipe Diameter of Largest Diameter Pipe in the Run (inch)	3/8	1/2	3/4	> 3/4
Maximum Run Length	30	20	10	5

Table 31.1 – Maximum Run Length (feet)<sup>a</sup>

For SI: 1 inch = 25.4 mm, 1 foot = 304.8 mm.

a. Total length of all piping from the distribution manifold or the recirculation loop to a point of use.

**31.5.5 TOWEL HEATERS**

Permanently installed towel heaters shall be provided with an automatic or readily *accessible* manual switch that can turn off the towel heater when the heater is not in use. Alternatively, towel heaters may be equipped with a timer.

**31.5.6 MECHANICAL VENTILATION.**

The building shall be provided with ventilation that meets the requirements of the *International Residential Code* or *International Mechanical Code*, as applicable, or with other approved means of ventilation. Outdoor air intakes and exhausts shall have automatic or gravity dampers that close when the ventilation system is not operating.

**31.5.6.1 WHOLE-HOUSE MECHANICAL VENTILATION SYSTEM FAN EFFICACY.**

Mechanical ventilation system fans shall meet the efficacy requirements of Table 33.2

Exception: Where mechanical ventilation fans are integral to tested and listed HVAC equipment, they shall be powered by an electronically commutated motor.

FAN LOCATION	AIR FLOW RATE MINIMUM (CFM)	MINIMUM EFFICACY (CFM/WATT)	AIR FLOW RATE MAXIMUM (CFM)
Range hoods	Any	2.8 cfm/watt	Any
In-line fan	Any	2.8 cfm/watt	Any
Bathroom, utility room	10	1.4 cfm/watt	< 90
Bathroom, utility room	90	2.8 cfm/watt	Any

Table 31.2 – Mechanical Ventilation System Fan Efficacy

For SI: 1 cfm = 28.3 L/min.

**31.5.7 SYSTEMS SERVING MULTIPLE DWELLING UNITS.**

Systems serving multiple dwelling units shall comply with Sections C403 and C404 of the IECC—Commercial Provisions in lieu of Section 32.5 of this code.

**31.5.8 POOLS AND INGROUND PERMANENTLY INSTALLED SPAS**

Pools and inground permanently installed spas shall comply with Sections 32.5.8.1 through 32.5.8.3.

**31.5.8.1 HEATERS.**

All heaters shall be equipped with a readily *accessible* on-off switch that is mounted outside of the heater to allow shutting off the heater without adjusting the thermostat setting. Gas-fired heaters shall not be equipped with constant burning pilot lights.

**31.5.8.2 TIME SWITCHES.**

Time switches or other control method that can automatically turn off and on heaters and pumps according to a preset schedule shall be installed on all heaters and pumps. Heaters, pumps and motors that have built in timers shall be deemed in compliance with this requirement.

Exceptions:

1. Where public health standards require 24-hour pump operation.
2. Where pumps are required to operate solar- and waste-heat-recovery pool heating systems.

**31.5.8.3 COVERS.**

Heated pools and inground permanently installed spas shall be provided with a vapor-retardant cover.

Exception:

Pools deriving over 70 percent of the energy for heating from site-recovered energy, such as a heat pump or solar energy source computed over an operating season.

**31.6 ELECTRICAL POWER AND LIGHTING SYSTEMS****31.6.1 LIGHTING EQUIPMENT**

A minimum of 75 percent of the lamps in permanently installed lighting fixtures shall be high-efficacy lamps or a minimum of 75 percent of the permanently installed lighting fixtures shall contain only high efficacy lamps.

Exception:

Low-voltage lighting shall not be required to utilize high-efficiency lamps.

**31.6.2 LIGHTING EQUIPMENT**

Fuel gas lighting systems shall not have continuously burning pilot lights.





## 32 ACCESSIBILITY GUIDELINES

### 32.1 DEFINITIONS

**Accessibility:** States Parties shall also take appropriate measures: (a) To develop, promulgate and monitor the implementation of minimum standards and guidelines for the accessibility of facilities and services open or provided to the public. (CRPD)

**Accessible Means of Egress:** A continuous and unobstructed way of egress travel from any point in a *building* or *facility* that provides an *accessible* route to an area of refuge, a horizontal exit, or a *public way*.

**Addition:** An expansion, extension, or increase in the gross floor area or height of a *building* or *facility*.

**Administrative Authority:** A governmental agency that adopts or enforces regulations and guidelines for the design, construction, or *alteration* of *buildings* and *facilities*.

**Alteration:** A change to a *building* or *facility* that affects or could affect the usability of the *building* or *facility* or portion thereof. *Alterations* include, but are not limited to, remodeling, renovation, rehabilitation, reconstruction, historic restoration, resurfacing of *circulation paths* or *vehicular ways*, changes or rearrangement of the structural parts or *elements*, and changes or rearrangement in the plan configuration of walls and full-height partitions. Normal maintenance, reroofing, painting or wallpapering, or changes to mechanical and electrical systems are not *alterations* unless they affect the usability of the *building* or *facility*.

**Apartment house:** Means a residential building that contains three or more dwelling units, and “apartment house development” shall be construed accordingly. (DEF.6 – Bermuda Plan 2008)

**Attached house:** Means a residential building on its own lot containing not more than one dwelling unit which is physically connected by a common wall to one or more residential buildings containing one dwelling unit each situated on its own lot, including, but not limited to, residential building forms referred to as row housing, terraced housing or town housing, and “attached” house development” shall be construed accordingly. DEF.7 – Bermuda Plan 2008)

**Building:** Any structure used or intended for supporting or sheltering any use or occupancy. (ADA)

**Building:** A structure, facility or portion thereof that contains or serves one or more dwelling units. (FHA)

**Building entrance on an accessible route:** An accessible entrance to a building that is connected by an accessible route to public transportation stops, to parking or passenger loading zones, or to public streets or sidewalks, if available.

**Circulation Path:** An exterior or interior way of passage provided for pedestrian travel, including but not limited to, *walks*, hallways, courtyards, elevators, platform lifts, *ramps*, stairways, and landings.

**Common Use:** Interior or exterior *circulation paths*, rooms, *spaces*, or *elements* that are not for *public use* and are made available for the shared use of two or more people.

**Cross Slope:** The slope that is perpendicular to the direction of travel (see *running slope*).

**Curb Ramp:** A short *ramp* cutting through a curb or built up to it.

**Detached unit:** Means a free-standing residential building containing not more than two dwelling units, and “detached house development” shall be construed accordingly. (DEF. 33 - Bermuda Plan 2008)

**Entrance:** Any access point to a *building* or portion of a *building* or *facility* used for the purpose of entering. An *entrance* includes the approach *walk*, the vertical access leading to the *entrance* platform, the *entrance* platform itself, vestibule if provided, the entry door or gate, and the hardware of the entry door or gate. (ADA)

**Entrance:** Any exterior access point to a building or portion of a building used by residents for the purpose of entering. For purposes of these guidelines, an “entrance” does not include a door to a loading dock or a door used primarily as a service entrance, even if non-handicapped residents occasionally use that door to enter. (FHA)

**Finished grade:** The ground surface of the site after all construction, levelling, grading, and development has been completed.

**Facility:** All or any portion of *buildings*, structures, *site* improvements, *elements*, and pedestrian routes or *vehicular ways* located on a *site*.

**Marked Crossing:** A crosswalk or other identified path intended for pedestrian use in crossing a *vehicular way*.

**Occupant Load:** The number of persons for which the means of egress of a *building* or portion of a *building* is designed.

**Ramp:** A walking surface that has a *running slope* steeper than 1:20.

**Residential Dwelling Unit:** A unit intended to be used as a residence, that is primarily long-term in nature. *Residential dwelling units* do not include *transient lodging*, inpatient medical care, licensed long-term care, and detention or correctional *facilities*.

**Running Slope:** The slope that is parallel to the direction of travel (see *cross slope*).

**Site:** A parcel of land bounded by a property line or a designated portion of a public right of way.

**Slope:** The relative steepness of the land between two points and calculated as follows: The distance and elevation between the two points (e.g., an entrance and a passenger loading zone) are determined from a topographical map. The difference in elevation is divided by the distance and that fraction is multiplied by 100 to obtain a percentage slope figure. For example, if a principal

entrance is ten feet from a passenger zone, and the principal entrance is raised one foot higher than the passenger loading zone, then the slope is  $1/10 \times 100 = 10\%$ .

**Site:** A parcel of land bounded by a property line or a designated portion of a public right-of-way.

**Space:** A definable area, such as a room, toilet room, hall, *assembly area*, *entrance*, storage room, alcove, courtyard, or lobby.

**Story:** That portion of a *building* or *facility* designed for human occupancy included between the upper surface of a floor and upper surface of the floor or roof next above. A *story* containing one or more *mezzanines* has more than one floor level.

**Tactile:** An object that can be perceived using the sense of touch.

**Transient Lodging:** A *building* or *facility* containing one or more guest room(s) for sleeping that provides accommodations that are primarily short-term in nature. *Transient lodging* does not include *residential dwelling units* intended to be used as a residence, inpatient medical care *facilities*, licensed long-term care *facilities*, detention or correctional *facilities*, or *private buildings or facilities* that contain not more than five rooms for rent or hire and that are actually occupied by the proprietor as the residence of such proprietor.

**Vehicular or pedestrian arrival points:** Public or resident parking areas, public transportation stops, passenger loading zones, and public streets or sidewalks.

**Vehicular route:** A route intended for vehicular traffic, such as a street, driveway, or parking lot.

**Walk:** An exterior prepared surface for pedestrian use, including pedestrian areas such as plazas and courts.

**Wheelchair Space:** *Space* for a single wheelchair and its occupant.

### 32.2 **PURPOSE**

This chapter of the code is an attempt to provide for the first time in Bermuda, an accessibility guideline for people with disabilities. Its purpose is to provide architects and designers with the basic information and data necessary for a barrier-free environment. Its intent is to establish standards and recommendations that will not only influence development forms but assume national importance as well. The manual is expected to be a stimulus that will lead, in the long run, to the establishment of national building and planning legislation covering accessibility design.

### 32.3 **SAFE HARBORS AND POINTS OF REFERENCE**

Since this will be the first time for Bermuda to incorporate an accessibility chapter the Single Dwelling Section will reference the **ADA 2010 Standards**, whereas, the Multi-dwelling section will model the **Fair Housing Act Design Manual 1996/8**. In addition to the Bermuda Residential Code 2012, authors of the code also recognize **other safe harbors** for compliance of the design and construction requirements. The Department recognizes that there are various documents that speak accessible design, as such; our approach discourages rigidity in regards to developments that

require accessible design. However, the responsible party should inform the Department of the code they wish to use. The other safe harbors are:-

#### 2010 Standards for Accessible Design

- The 2010 Standards set minimum requirements – both scoping and technical – for newly designed and constructed or altered State and local government facilities, public accommodations, and commercial facilities to be readily accessible to and usable by individuals with disabilities.

#### ICC A117.1 – 2009 American National Standard;

- This document mostly deals with technical recommendations to make sites, facilities, buildings and elements accessible to and usable by people with physical disabilities

#### Fair Housing Act design Manual 1996/8

- The manual provides comprehensive information about accessibility requirements which must be incorporated in the design and construction of multifamily housing

#### Universal Design: Definition imposed by the United Nations

- “Universal design” means the design of products, environments, programmes and services to be usable by all people, to the greatest extent possible, without the need for adaptation or specialized design.

**32.4 PART 1 - MULTI-DWELLINGS**

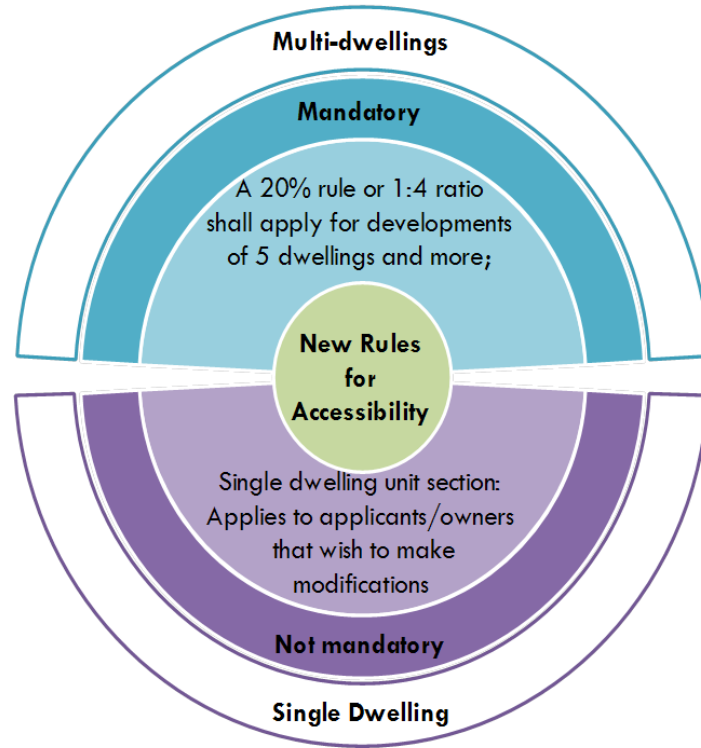

Figure 32-1: Accessibility for Multi-Dwellings

**32.5 THE NEW RULE FOR MULTI-DWELLING UNITS**

This rule applies to multi-dwellings proposal of 5 or more dwelling units will have to comply with the 1 in 5 or 20% ratio which will require an accessibility unit (including those in town house style formation) see example 1. If in the event that the number is an odd number you would have to round up or down to the nearest whole number see example 2.

$\frac{1}{5}$ or 20% (.2)	×	5 units 10 units	=	1 unit 2 units
Example 1: When there is an even or exact calculation				
$\frac{1}{5}$ or 20% (.2)	×	9 units 46 units	=	1.8 rounds up to 2 units 9.2 rounds down to 9 units
Example 2: Round up or down to the nearest 10 <sup>th</sup>				

**DEFINITIONS TO INTERPRET TABLES**

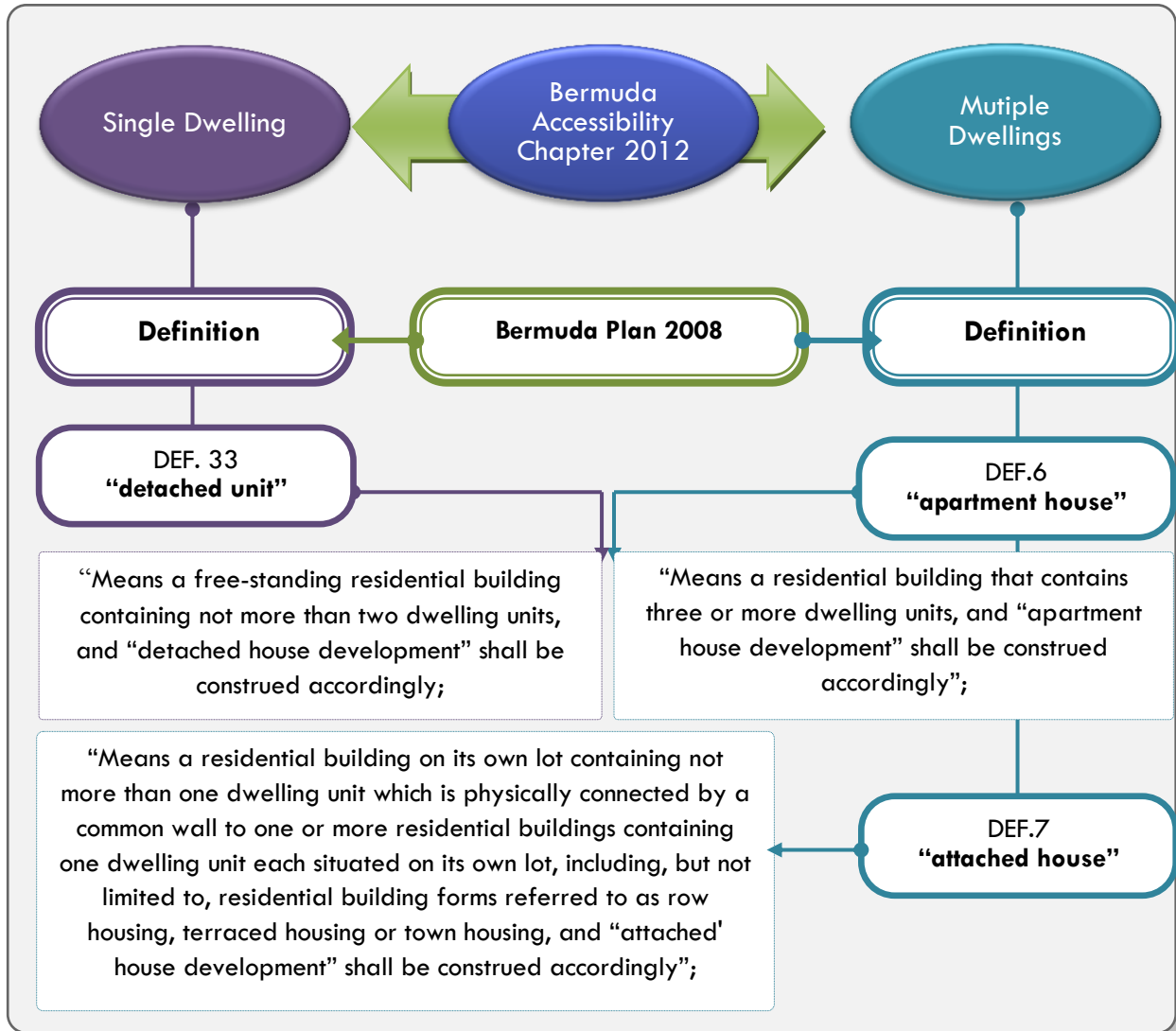

EXISTING		Explanation of types of 'Dwellings' - Dwelling Type	
<b>Dwelling</b>	<b>Single Dwelling</b>	<b>Multiple Dwelling</b>	
<b>Document Type.</b>	The Bermuda Plan 2008	"Attached house"	
<b>Definition</b>	See table above	"Apartment house"	See table above
<b>Document</b>	The Bermuda Residential Building Code 1998		
<b>Definition</b>	Residential Building Code applies to residential dwellings not exceeding 5000 sq-ft in area on any floor level, and not exceeding 2 stories or 24 feet in height.	'multiple single family dwelling units located above or adjacent to other single family dwelling units, such as condominiums, shall be considered as part of this code as long as the fire separation requirements of Chapter 18 are complied with and as long as each dwelling unit has its own independent means of egress. This means that no common egress elements serving more than one dwelling unit are utilized in the design.'	

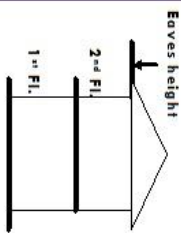
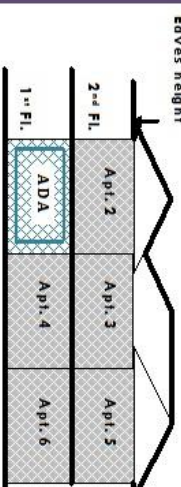
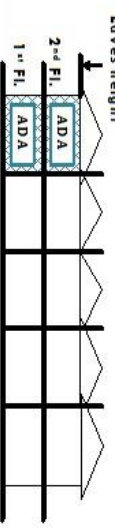
Residential Building Code 2014a - ADA Requirements – When does the rule apply?												
Type	Single Dwelling	Multiple Dwelling										
Category	“Detached house”	“Apartment house”      “Attached house”										
<b>Rule</b>	The accessibility chapter will not apply to single residences UNLESS the applicant wishes to construct a new build or make modifications to an existing residence (see appendix;	<p><b>The rule of 1 in 5 or 20% dwellings units will have to be ADA compliant</b></p> <p><b>Exceptions:</b></p> <p>1 For large residential proposals, the percentage can be decreased to 10% or increased to 25%;</p> <p>2 For large residential proposals all lower units may be made accessible;</p> <p>Each case will be decided internally or through a board of panel members based on *site practicability, the merits of the proposal or at the discretion of the Planning Board</p>										
<b>Decision</b>	Not applicable	<p>Each case will be decided internally or through a board of panel members based on *site practicability, the merits of the proposal or at the discretion of the Planning Board</p>										
<b>Simplified Examples for ADA Compliance</b>												
<b>Elevations</b>												
		 <p><b>Different scenarios</b></p> <p>Scenario 1 for ADA Compliance</p> <table border="1"> <tr> <td>Unit 1</td> <td>Unit 2</td> <td>Unit 3</td> <td>Unit 4</td> <td>Unit 5</td> </tr> </table> <p>Scenario 2 for ADA Compliance</p> <table border="1"> <tr> <td>Unit 1 &amp; 2</td> <td>Unit 3 &amp; 4</td> <td>Unit 5 &amp; 6</td> <td>Unit 7 &amp; 8</td> <td>Unit 9 &amp; 10</td> </tr> </table>	Unit 1	Unit 2	Unit 3	Unit 4	Unit 5	Unit 1 & 2	Unit 3 & 4	Unit 5 & 6	Unit 7 & 8	Unit 9 & 10
Unit 1	Unit 2	Unit 3	Unit 4	Unit 5								
Unit 1 & 2	Unit 3 & 4	Unit 5 & 6	Unit 7 & 8	Unit 9 & 10								





<b>EXISTING</b>	<b>Explanation of types of 'Dwellings' - Dwelling Type</b>		
<b>Dwelling</b>	<i>Single Dwelling</i>	<i>Multiple Dwelling</i>	
<b>Document</b>	The Bermuda Plan 2008		
<b>Type.</b>	<i>"Detached house"</i>	<i>"Apartment house"</i>	<i>"Attached house"</i>
<b>Definition</b>	See table above	See table above	See table above
<b>Document</b>	The Bermuda Residential Building Code 1998		

**32.6 THE SEVEN REQUIREMENTS FOR MULTI-DWELLINGS (PART 1)**

The design requirements of the Guidelines to which new buildings and dwelling units must comply are presented below. Dwelling units are not subject to these requirements only in the rare instance where there are extremes of terrain or unusual characteristics of the site. Such instances are discussed in detail in Chapter One: "Accessible Building Entrance on an Accessible Route.

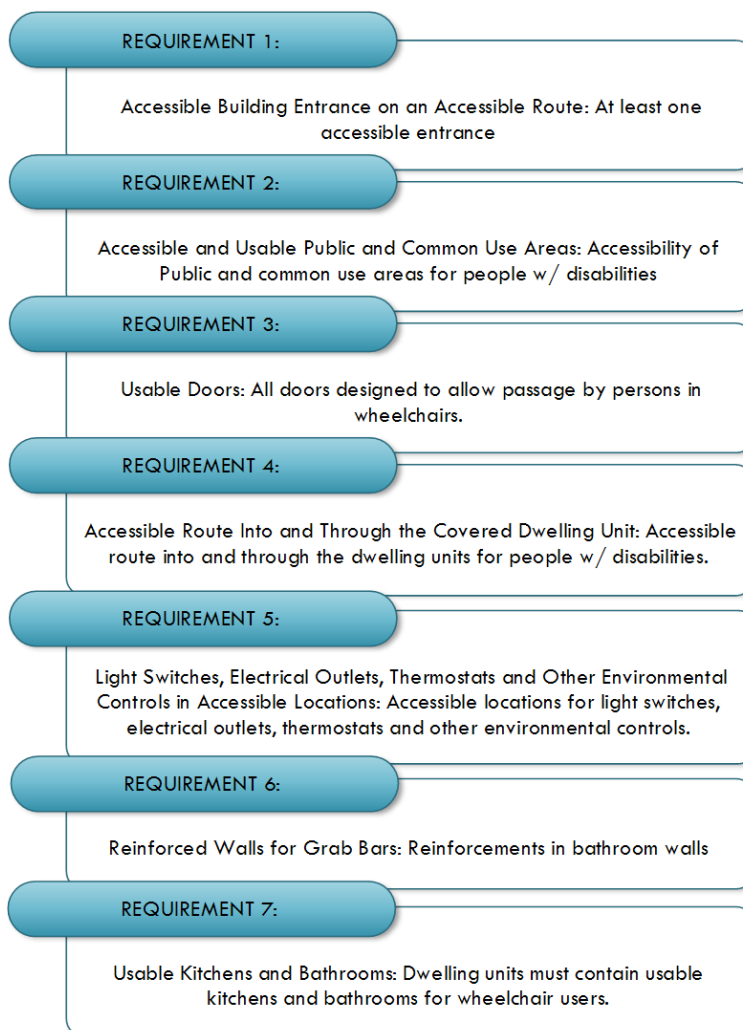

## 32.7 ACCESSIBLE ROUTES

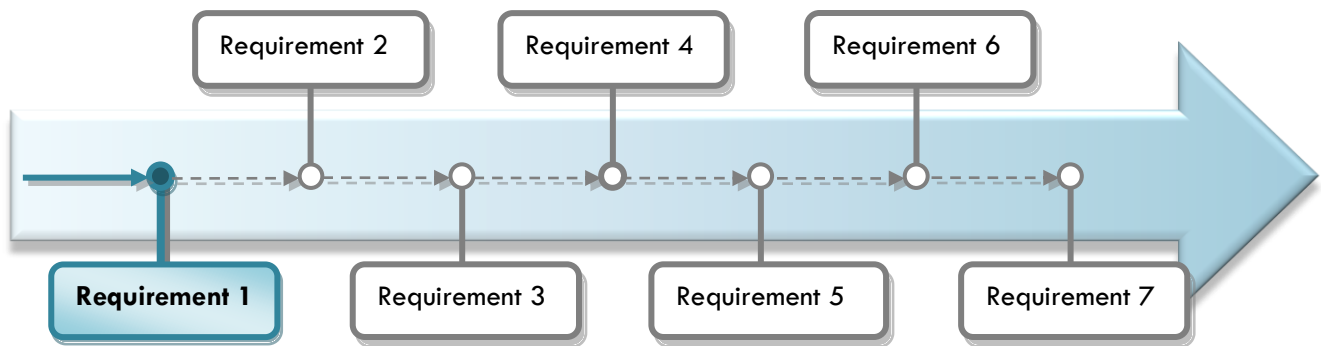

### 32.7.1 **BACKGROUND**

Requirement 1 of the Guidelines presents guidance on designing an accessible building entrance on an accessible route. Accessible routes and accessible entrances may occur in the course of any design project. They also may not occur and be expensive to include later if a careful approach to site design is not conducted.

Planning for accessibility should be an integral part of the design process in multifamily housing developments. This is particularly crucial in the early stages of planning when major decisions are being made about the overall design of the site. The location and orientation of buildings, parking areas, loading zones, and other elements have a major impact on the ease with which accessibility can be achieved in a finished development. This is especially important on sloping sites where careful initial planning can eliminate the need for major earthwork and the construction of elaborate ramps, bridges, lifts, or elevators to provide accessibility. Attempts should be made to set the entrance floor levels of buildings at or close to ground levels to eliminate or minimize changes in level that may require steps or ramps. Often this may be accomplished by making use of fill dirt which has been excavated from other parts of the building site to alter the ground levels at appropriate places.

Since people generally arrive at buildings by a private car, bus, or taxi, the location of vehicle arrival points is critical. Passenger drop-off points and parking areas for people with disabilities should be located close to building entrances and at levels which do not necessitate climbing steep slopes to reach the entrance floor level.

The path of travel to and placement of site amenities, such as outside mailboxes, refuse disposal areas, swimming pools, clubhouses, and sports facilities should be given careful consideration early in the planning process. The intent of this magnitude ensures that people with disabilities are able to reach and use such amenities

### 32.7.2 WHAT IS AN ACCESSIBLE ROUTE?

An accessible route is a continuous, unobstructed path through sites and buildings that connects all accessible features, elements, and spaces. It is the critical element that allows the successful use of any site or building by a person with a disability. Such a route is safe for someone using a wheelchair or scooter and also is usable by others.

Accessible routes on a site may include parking spaces, parking access aisles, curb ramps, walks, ramps, and lifts. Accessible routes within buildings may include corridors, doorways, floors, ramps, elevators, and lifts. Specifications for accessible routes are found in Chapter 6 of this guideline. Certain elements of accessible routes which must be given careful attention are:

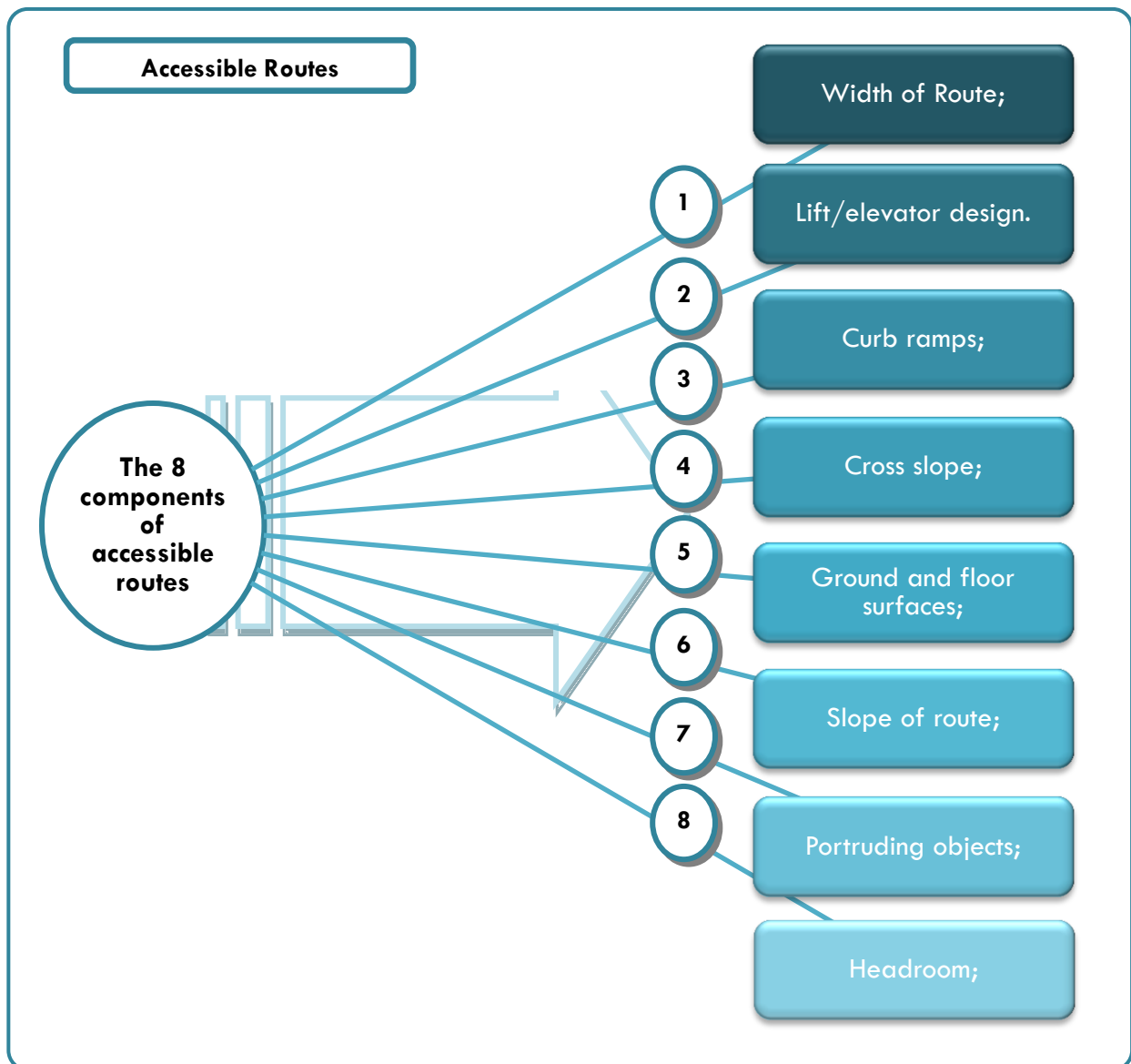

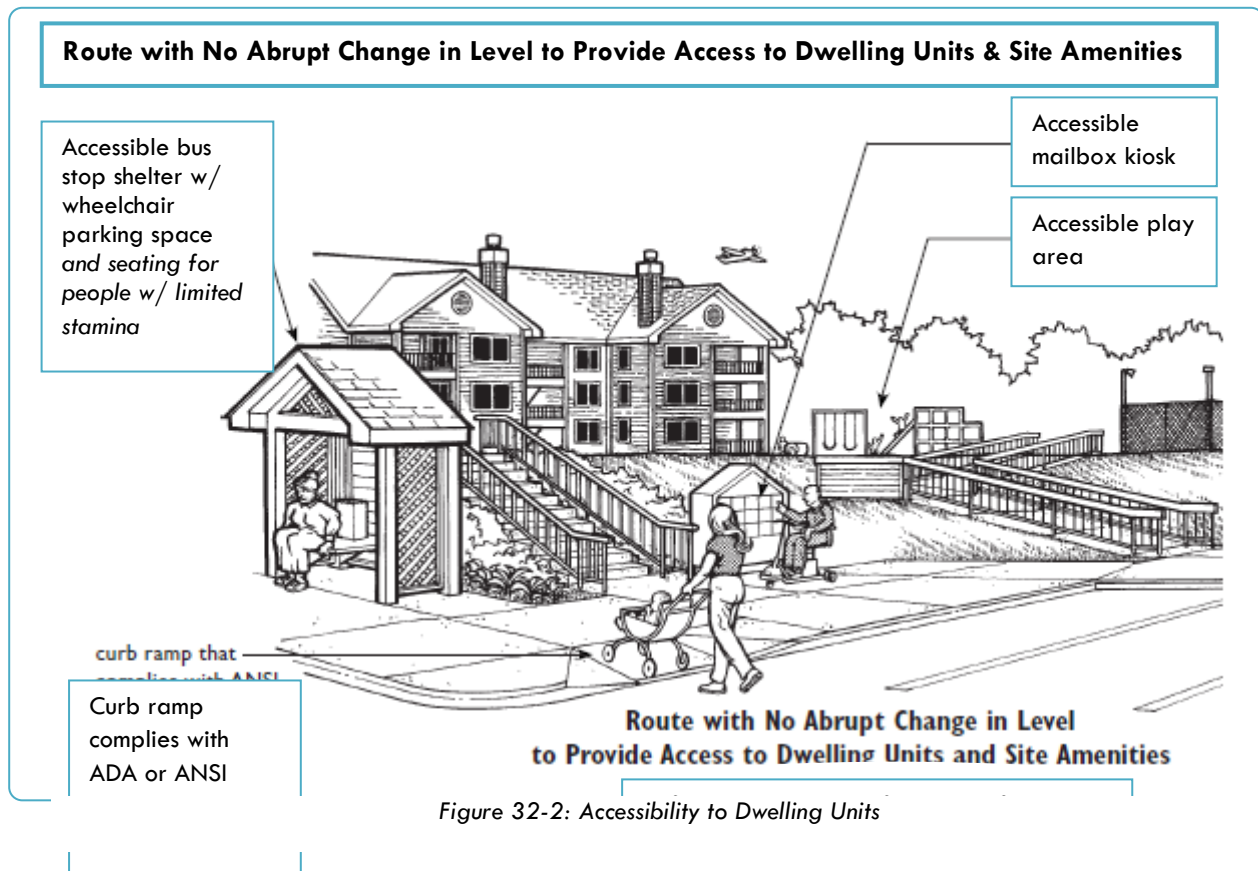

### 32.7.3 STAIRS AND ACCESSIBLE ROUTES

Stairs are not an acceptable component of an accessible route because they prevent use by people using wheelchairs and others who cannot climb steps. The 2010 ADA Standards for Accessible Design provide specifications (Chapter 5: 504 Stairways) to make stairs safer and more usable by mobility impaired people who can climb stairs.

By definition the 2010 ADA Standards for Accessible Design specifically states, that, *'Changes in level are not permitted'* (504.4), however, when stairs are installed along routes that are required to be accessible, there must be an alternative way to get between levels. If the alternative way is an elevator or lift, the stairs do not need to comply with the 2010 ADA Standards for Accessible Design. If the alternative way is a ramp, the stairs must comply with the requirements of the same code. When an accessible route consists of both a ramp and stairs, it is best if they are located in close proximity so people who can use only one of the two (such as the ramp), need not travel an unreasonable additional distance.

### 32.7.4 WALKS ON ACCESSIBLE ROUTES

Walks that are part of accessible routes become ramps when their slope exceeds 5% (1 in 20). Handrails are not required on walks with slopes between 0% and 5%, but they are required on those steeper than 5% and up to 8.33% (1 in 12). Slopes steeper than 8.33% are not usable by most

people with disabilities and cannot be considered part of an accessible route. Handrail requirements for walks differ, depending upon which buildings the walks connect. This is addressed in the following sections.

### **32.7.5 WHERE ARE ACCESSIBLE ROUTES REQUIRED ON SITES?**

#### **32.7.5.1 ACCESSIBLE ROUTE FROM SITE ARRIVAL POINTS TO ACCESSIBLE BUILDING ENTRANCES**

The Guidelines require that an accessible route be provided from public transportation stops, accessible parking spaces, accessible passenger loading zones, and public streets or sidewalks to accessible building entrances unless it is impractical to do so as determined by application of the site tests specified in Requirement 1 (site impracticality due to terrain or unusual site characteristics, see page 1.38). Because these walkways are required to be accessible, handrails, as per ANSI, must be provided when the slope of the walk is between 5% (1 in 20) and 8.33% (1 in 12).

#### **32.7.5.2 ACCESSIBLE ROUTES AND WALKS BETWEEN ACCESSIBLE BUILDINGS AND SITE FACILITIES**

The Guidelines require accessible routes to connect buildings containing covered dwelling units (those with one or more elevators and ground floors of other buildings, except two-story townhouses) and accessible facilities, elements, and spaces on the same site. The Guidelines do not require accessible routes, walks, or paths between buildings containing only covered dwelling units unless the route is also part of a required accessible route. For example, if a building also contains a facility such as a laundry that is shared by two buildings, then an accessible route must be provided between the two buildings. If no portion of the finished grade of a route between two buildings that contain only dwelling units exceeds 8.33% (1 in 12), it is recommended that the route be made accessible. Such voluntary accessible walks must meet the same specifications as an accessible route except that handrails, commonly required on accessible routes when their slope exceeds 5% (1 in 20), are not required.

#### **32.7.5.3 ACCESSIBLE SITE FACILITIES ON ACCESSIBLE ROUTES**

The Guidelines require accessible and usable public and common use areas. All facilities, elements, and spaces that are part of public and common use areas must meet ANSI 4.1 through 4.30 and must be on an accessible route from covered dwelling units. Such facilities might include outside mailboxes, site furnishings, outside storage areas, refuse disposal areas, playing fields, amphitheaters, picnic sites, swimming pools and sun decks, tennis courts, clubhouses, playgrounds, gazebos, parking areas, sidewalks, and all or part of nature trails and jogging paths.

Where multiple recreational facilities of the same type are provided at the same location on the site (e.g., tennis courts), not all but a “sufficient” number of the facilities must be accessible to ensure an equitable opportunity for use by people with disabilities. Whenever only one of a type of recreational facility is provided at a particular location on the site, it must be accessible and connected by an accessible route to the covered dwelling units. (See Requirement 2: “Accessible Public and Common Use Spaces”).

### 32.7.5.4 USE OF VEHICLES FOR ACCESS TO SITE FACILITIES

When the finished grade exceeds 1 in 12 or other physical barriers (natural or man-made) or legal restrictions, all of which are outside the control of the owner, prevent the installation of an accessible pedestrian route between covered dwellings and some public or common use site facilities; the Guidelines allow for cars to be used for access if certain conditions are met. When such a vehicular route is used as an alternative method to achieve accessibility:

- ♿ the required parking at covered dwelling units must be provided, and
- ♿ an appropriate number of additional accessible parking spaces on an accessible route must be provided at each facility that is otherwise unreachable by means of an accessible pedestrian route. (For a complete discussion of parking requirements, see *Chapter 2: "Accessible and Usable Public and Common Use Areas"* of the Fair Housing Act.)

Careful planning and strategic location of accessible parking spaces and curb ramps around dwelling units and amenities will help give continuity between vehicular and pedestrian accessible routes. Accessible parking spaces and curb ramps are recommended at all on-site amenities to give residents choices in how to reach them, even those served by accessible pedestrian routes. This is especially important where accessible routes are very long and where parts or all of the route have maximum allowable slopes of 1 in 12 (1:12), which are difficult or impossible for many people to use (see figure below)

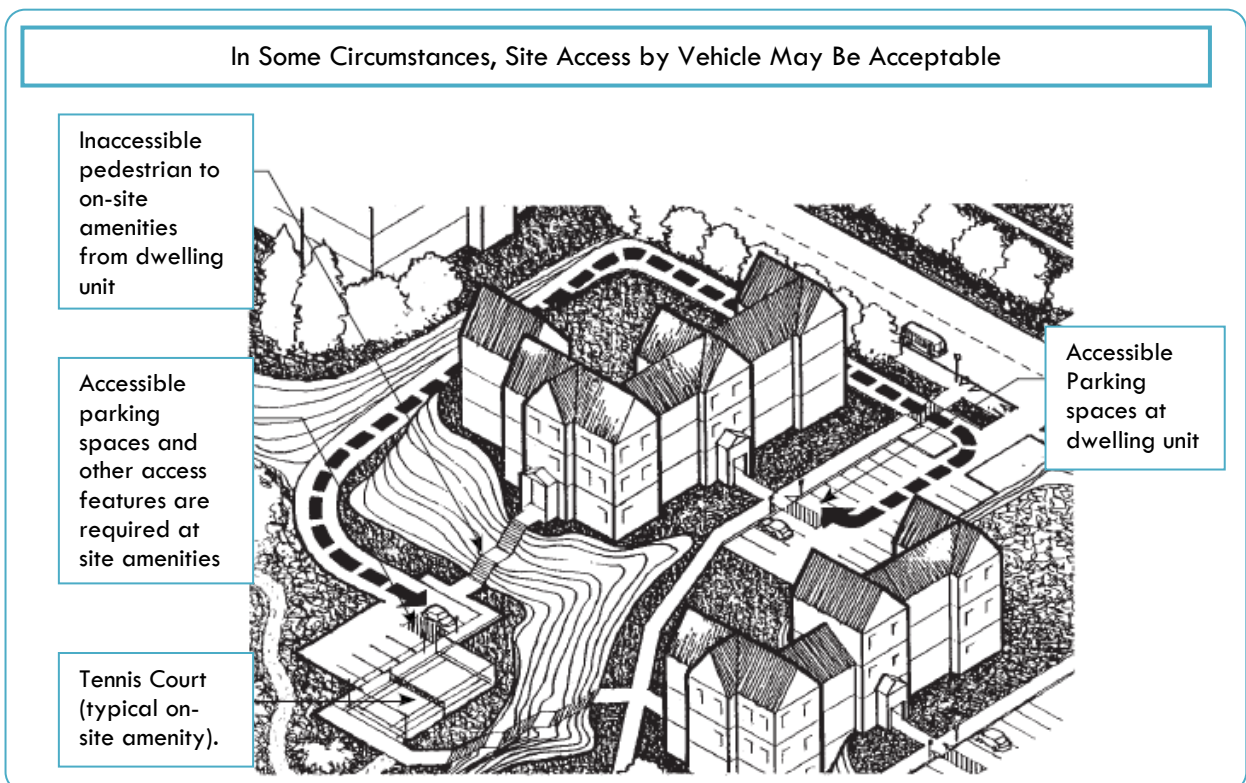

Figure 32-3: Site Access by Vehicle May Be Acceptable  
Source: Fair housing Act

**32.7.6 ACCESSIBLE ENTRANCES**

All buildings containing covered dwelling units and separate buildings containing public and common use spaces, such as clubhouses, must have at least one accessible building entrance on an accessible route, unless it is impractical to do so as determined by the *Building Official*. Entrances into individual dwellings on an interior accessible route are referred to in the Guidelines as “entries.” These entries and the entries to dwelling units having separate exterior ground floor entrances will be discussed in Chapter 3: “Usable Doors.” The Guidelines establish three requirements for an accessible building entrance.

**32.7.6.1 ACCESSIBLE BUILDING ENTRANCE ON AN ACCESSIBLE ROUTE**

The building entrance must be connected by an accessible route to public transportation stops, to accessible parking and passenger loading zones, and to public streets or sidewalks.

**32.7.6.2 PRIMARY USE**

The accessible (common use) entrance must be one which is typically used by residents and/or guests for the purpose of entering the building. Service doors or loading docks cannot serve as the only accessible entrance to buildings, even if residents occasionally use such a door for entering the building (see figure to the right).

**32.7.6.3 BUILDING ENTRANCE DESIGN FEATURES**

The entrance door itself must be usable by people with disabilities. Detailed specifications to achieve this are given in the ADA Guidelines. Accessible building entrances are considered public and common use spaces and, unlike unit entrances, must meet the ADA requirements on both sides of the door. Main factors which must be addressed are noted in the figure to the right.

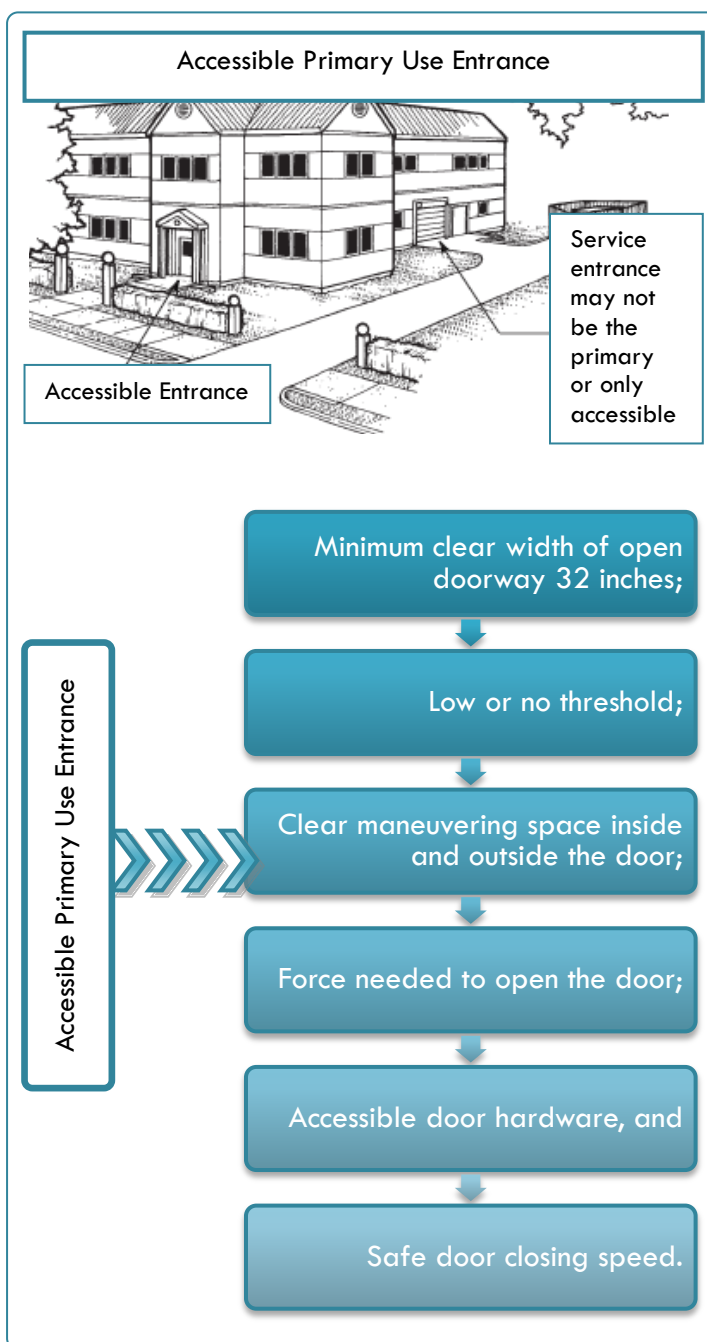



## 32.8 ACCESSIBLE AND USABLE PUBLIC AND COMMON USE AREAS

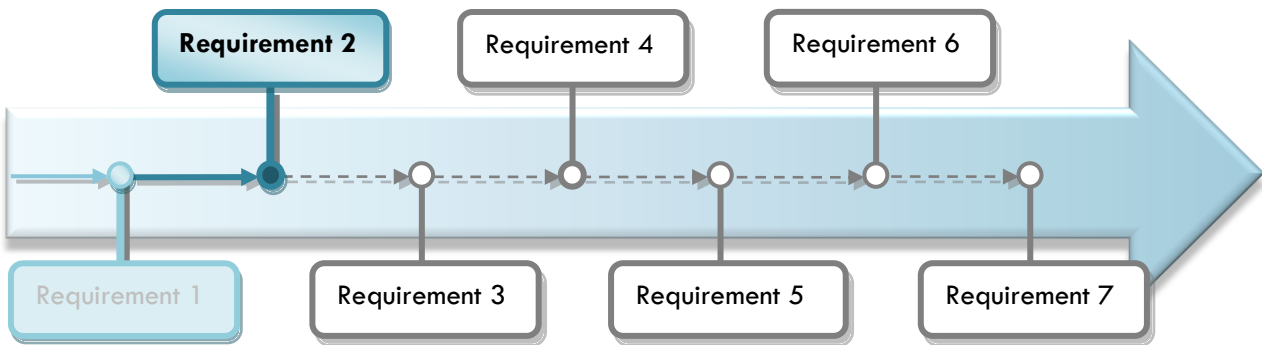

### 32.8.1 BACKGROUND

The Fair Housing Accessibility Guidelines (the Guidelines) require public and common use areas and facilities in multifamily housing developments to be accessible to people with disabilities so they may benefit from and enjoy the amenities present in the housing development in which they live. Public and common use areas that must be accessible include, but are not limited to, such spaces and elements as selected on-site walks, parking, corridors, lobbies, swimming pool decks, playgrounds, rental offices, mailbox areas, trash rooms/refuse disposal areas, clubhouses, tennis courts, game rooms, toilet rooms and bathing facilities, laundries, community rooms, and portions of common use tenant storage.

The Guidelines require an accessible route to public and common use spaces, but not all features or elements within that space may be required to be accessible. The scoping provisions, or “where,” “when,” and “how many” elements and spaces must be accessible, will be addressed throughout this chapter. For example, where multiple recreational facilities are provided, the Guidelines do not require that each amenity be accessible, but rather that “sufficient numbers” be accessible to provide equitable use by people with disabilities. In general, however, if each building on a site has its own trash room, lounge area, laundry room, game room, etc., then each of these in each building must be on an accessible route and comply with the applicable portions of an appropriate accessibility standard since they serve different buildings.

### 32.8.2 MULTIPLE RECREATION FACILITIES

Where multiple recreational facilities of the same type are provided at the same location on the site (e.g., tennis courts), not all but a “sufficient” number of the facilities must be accessible to ensure an equitable opportunity for use by people with disabilities. It is recommended that all recreational facilities be accessible when the site is relatively flat and this can be easily achieved. Whenever only one of a type of recreational facility is provided at a particular location on the site, it must be accessible and connected by an accessible route to the covered dwelling units. In instances where each building or cluster of buildings is served by its own recreational facility e.g., a swimming pool, then the facility must be on an accessible route from the covered dwelling units.

### 32.8.3 ACCESSIBLE ROUTE

An accessible route is a path that is at least 36 inches wide, smooth, as level as possible, and without hazards or obstructions. Within the boundary of the site, an accessible walk or route on a site must connect public transportation stops, accessible parking spaces, accessible passenger loading zones,

and public streets and sidewalks to accessible building entrances. Such accessible walks and routes are subject to site constraints discussed in *Requirement 1: "Accessible Building Entrance on an Accessible Route."* In addition, an accessible route must connect accessible buildings with public and common use site amenities. The accessible route links all accessible elements and features on a site and within a building, making it possible for people with a wide range of disabilities to maneuver safely and use a facility successfully (see figure below).

**32.8.4 WITHIN A SITE**

Within a site at least one *accessible route* shall connect *accessible buildings, accessible facilities, accessible elements, and accessible spaces* that are on the same *site*.

**EXCEPTION:** An *accessible route* shall not be required between *accessible buildings, accessible facilities, accessible elements, and accessible spaces* if the only means of access between them is a *vehicular way* not providing pedestrian access. **206.2.2**

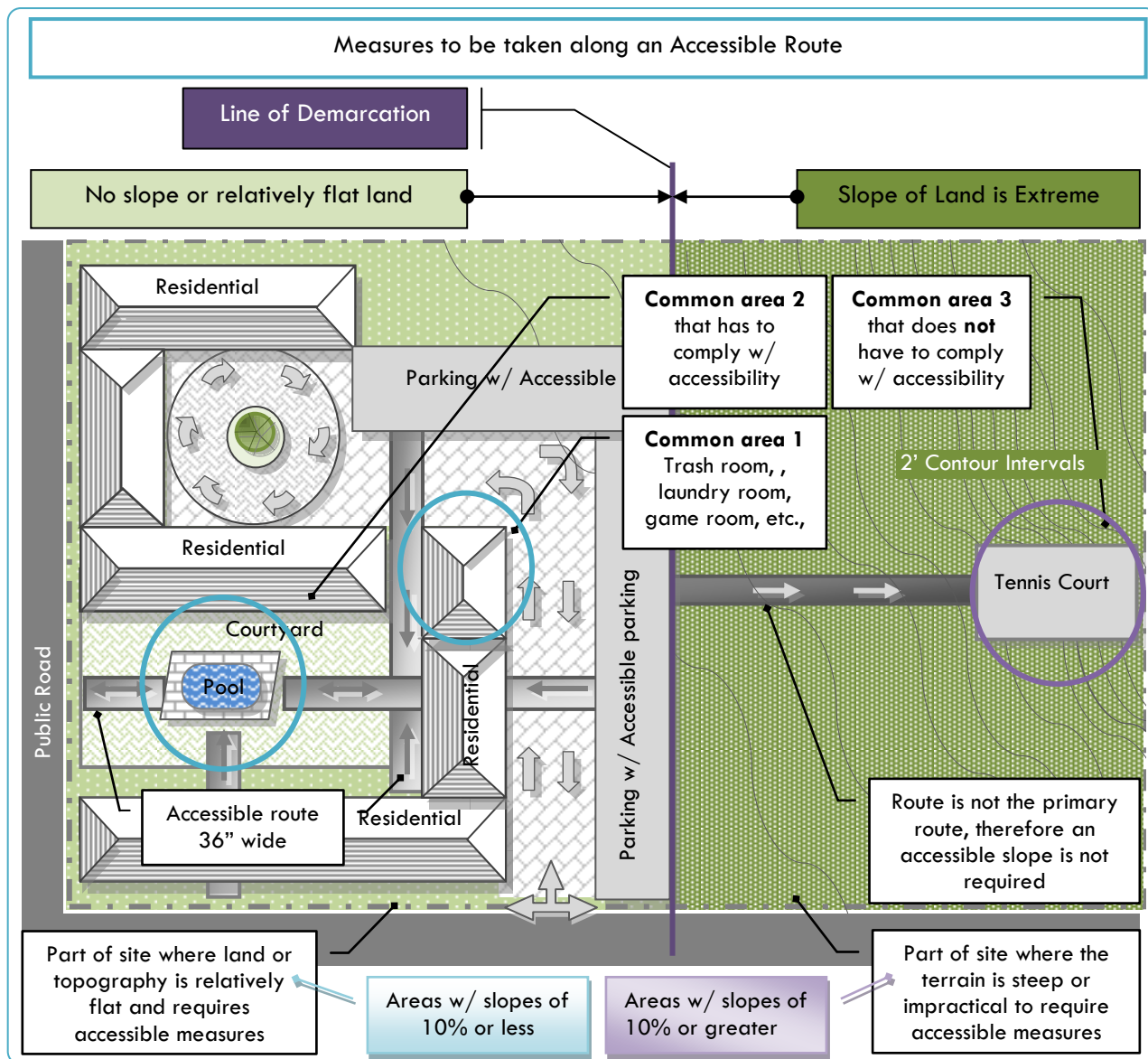

### 32.8.5 STAIRS AND ACCESSIBLE ROUTES

By definition and the 2010 ADA Standards for Accessible Design **504.4 - Changes in Level**, a stair can never be part of an accessible route, i.e., a stair can never interrupt or be part of the path of an accessible route. Elevators, ramps, and mechanical lifts, however, can be part of an accessible route. In view of the fact that some users have difficulty walking on ramps and are safer using appropriately designed stairs, it is always best that stairs be placed adjacent to or nearby ramps that are used to provide an accessible route between levels not served by elevators (see figure below).

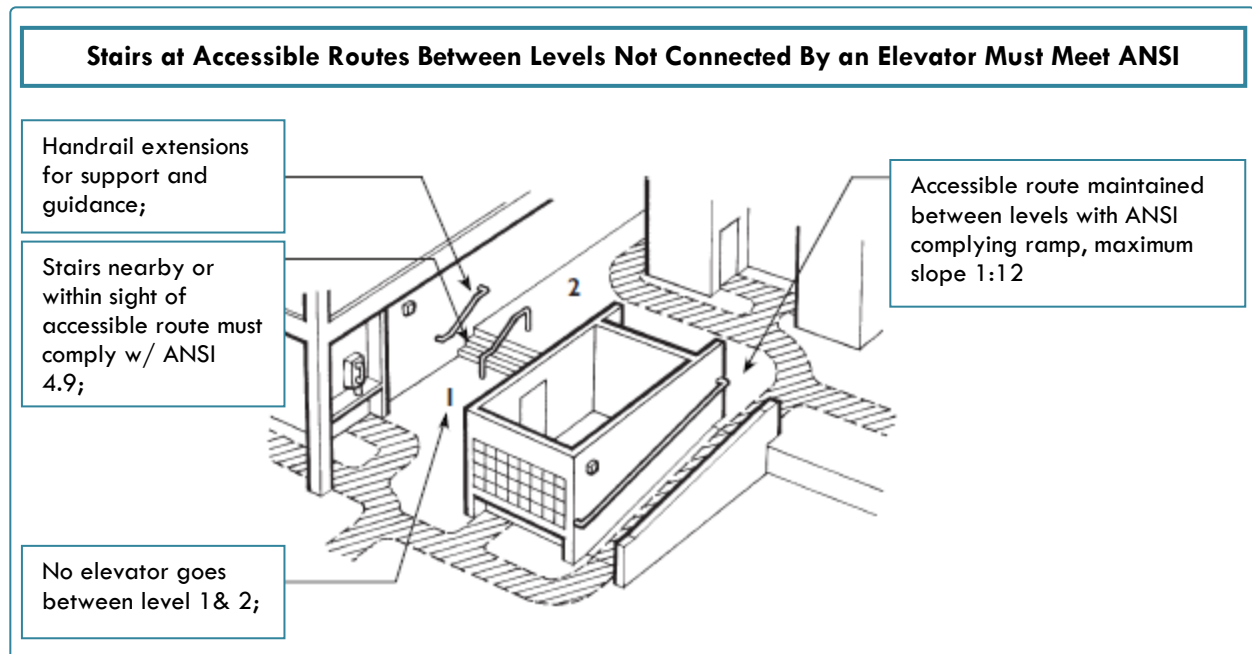

### 32.8.6 PROTRUDING OBJECTS

Many people with visual impairments use a long cane for guidance. The cane is used to follow a “shoreline” such as the edge of a sidewalk or a curb or, indoors, the baseboard of a wall. The cane, when swept ahead of the user, also detects obstacles in the path. Objects which protrude from walls or hang from overhead are not detectable and are, therefore, hazardous because a person with a visual disability cannot avoid running into them.

Detectable items are obstacles that can be maneuvered around. There must always be a 36-inch wide accessible route around any obstacle. Large wall-mounted items such as fire extinguishers and telephone enclosures must be recessed, set in alcoves, or designed so they have structures extending close to the floor, no higher than 27 inches, and within the long cane detectable area.

### 32.8.7 ACCESSIBLE PARKING ON AN ACCESSIBLE ROUTE

When parking is provided on a residential site, accessible parking spaces on an accessible route must be provided for residents and visitors. Accessible parking spaces must meet the requirements for parking in the ADA or ANSI and be located on the shortest possible accessible circulation route to an accessible entrance, subject to site considerations in Chapter 1 or Requirement 1.

**32.8.8 ACCESS AISLES**

Parking spaces must be wide enough to allow people using wheelchairs or mobility aids to move between cars and to enter cars or vans. Accessible parking spaces must be at least 96 inches wide and have an adjacent access aisle that is 60 inches wide. This 60-inch access aisle is regarded as a minimum, and although it is adequate for people using wheelchairs who can transfer into and out of cars, it is too narrow for safe and comfortable use for people who drive vans. The Guidelines do not require nor specify the size of van-accessible access aisles. The only nationally accepted design standard that contains such a specification is the Americans with Disabilities Act Accessibility Guidelines (ADAAG), which specify that a van parking access aisle must be at least 96 inches wide and is required at sales and rental offices.

**32.8.9 CURB RAMPS (2010 ADA STANDARDS FOR ACCESSIBLE DESIGN 406 CURB RAMPS)**

Curb ramps are transitions between roads, parking areas, access aisles, and sidewalks that allow a pedestrian route to remain accessible to people who use wheelchairs and other mobility aids, see figure below. Curb ramps are a necessity for people with mobility impairments but are a hazard to people who are blind who use the curb as a “cue” to know when they are entering the street. The standards have previously required a texture on curb ramp surfaces to make them detectable, however, the Fair Housing Act reports that such textures often do not provide enough of a cue and a person with a visual impairment may inadvertently enter the street. Locating curb ramps out of the usual line of pedestrian flow and “shorelines” (edge between sidewalk and grass or other cane detectable surface) can prevent such tendencies (see diagram below).

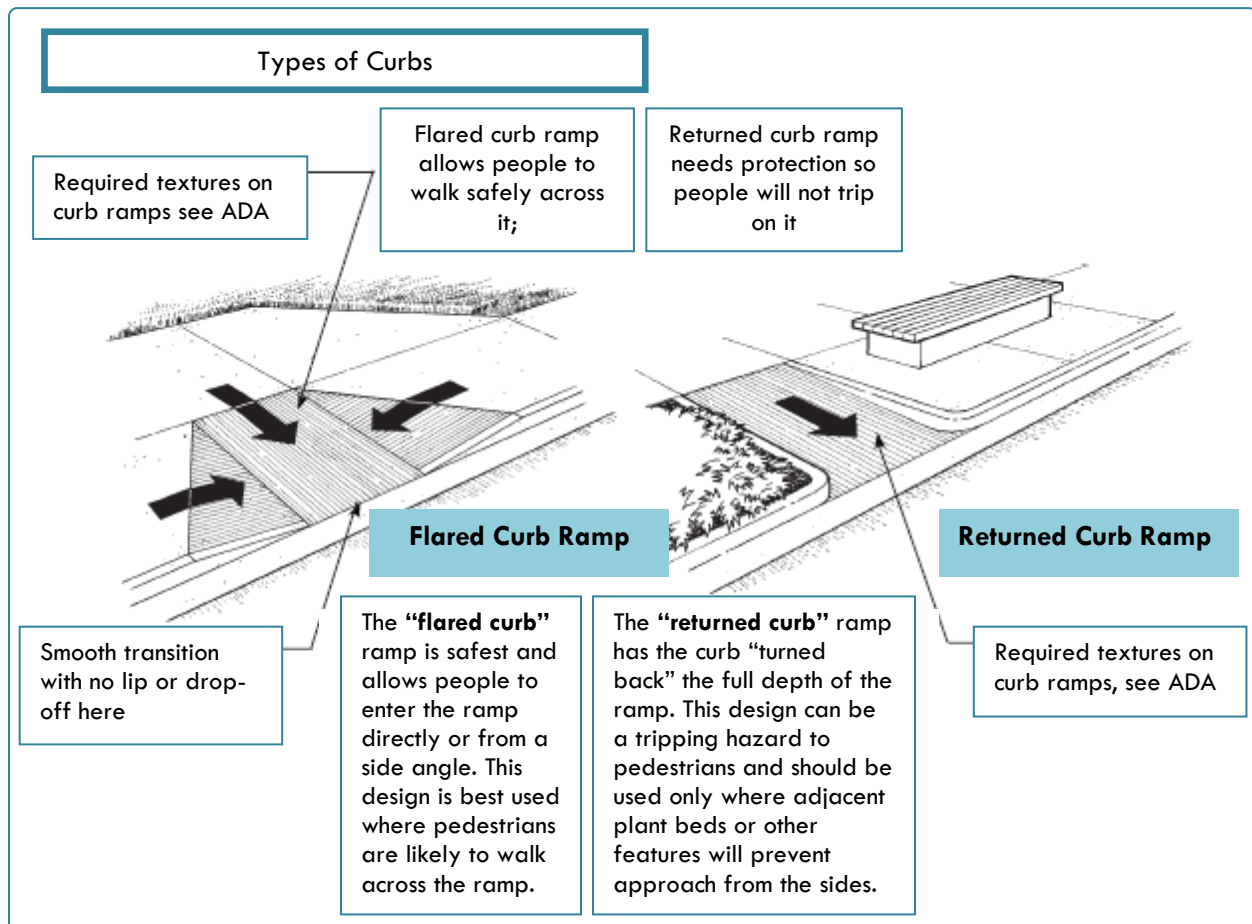

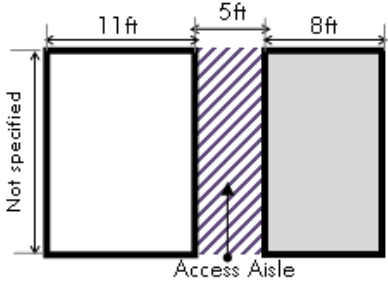
Planning Requirements	Building Code Requirements
<b>Parking – Bermuda Plan 2008</b>	2010 ADA Standards to Accessible Design, ICC A117.1 – 2009, IBC 2006,
<b>Parking – Bermuda Plan 2008</b> Accessibility and Access Statement Guidance Note.	Chapter 5. General Site and Building Elements
<p>Note: Parking requirements differ with that of the Building Code as such applicants are advised that the requirements of the current Building will apply.</p>	<b>502 Parking Spaces</b>
	<b>502.2 Vehicle Space Size.</b> Car parking spaces shall be 96 inches (2440 mm) minimum in width. Van parking spaces shall be 132 inches (3350 mm) minimum in width.
	<b>EXCEPTION:</b> Van parking spaces shall be permitted to be 96 inches (2440 mm) minimum in width where the adjacent access aisle is 96 inches (2440 mm) minimum in width.
	<b>502.3 Vehicle Space Marking.</b> Car and van parking spaces shall be marked to define the width. Where parking spaces are marked with lines, the width measurements of parking spaces and adjacent access aisles shall be made from the centerline of the markings.
	<b>Access Aisles</b>
	<b>502.4 Access Aisle.</b> Car and van parking spaces shall have an adjacent access aisle complying with Section 502.4.
	<b>502.4.2 Width.</b> Access aisles serving car and van parking spaces shall be 60 inches (1525 mm) minimum in width.
	<b>502.4.3 Length.</b> Access aisles shall extend the full length of the parking spaces they serve.
<b>502.4.4 Marking.</b> Access aisles shall be marked so as to discourage parking in them. Where access aisles are marked with lines, the width measurements of access aisles and adjacent parking spaces shall be made from the centerline of the markings	
<b>502.5 Floor Surfaces.</b> Parking spaces and access aisles shall comply with Section 302 and have surface slopes not steeper than 1:48. Access aisles shall be at the same level as the parking spaces they serve.	
	
<p>For more information refer to <b>Part 2</b> of this code (2010 ADA Standards to Accessible Design, ICC A117.1 – 2009, IBC 2006 specifically Building Blocks, Accessible Routes</p>	

### 32.8.10 VISITOR ACCESSIBLE PARKING (RECOMMENDATION)

If visitor parking is provided, accessible parking spaces for visitors also must be provided. The Guidelines do not specify a number or percentage of accessible visitor spaces, but provide that such parking must be “sufficient” to provide access to grade level entrances of multi dwellings. To allow people with disabilities to visit and have access to such entrances on an equitable basis, it is recommended that accessible visitor spaces be dispersed throughout the site, and that *several spaces* be provided at a building with *large numbers* of dwelling units. The table below provides a description of parking requirements specified in the Bermuda Plan 2008, 2010 ADA Standards to Accessible Design, ICC A117.1 – 2009, and IBC 2006

### 32.8.11 BACKGROUND

**Accessible doors** in public and common use spaces and primary entry doors of dwelling units must provide a clear opening of **32 inches minimum**. This means the clear opening must not be less than 32 inches, but it may be more.

### 32.8.12 DOOR WIDTH

According to the 2010 ADA Standards for Accessible Design ‘404.3.1 Clear Width...Doorways shall provide a clear opening of 32 inches (815 mm) minimum in power-on and power-off mode (see figure to right). The minimum clear width for automatic door systems in a doorway shall be based on the clear opening provided by all leaves in the open position ‘with the door open 90 degrees, measured between the face of the door and the opposite stop (4.13.5: ADA Accessibility Guidelines).

**\*EXCEPTION:** Doors not requiring full user passage, such as shallow closets, may have the clear opening reduced to 20 in (510 mm) minimum.

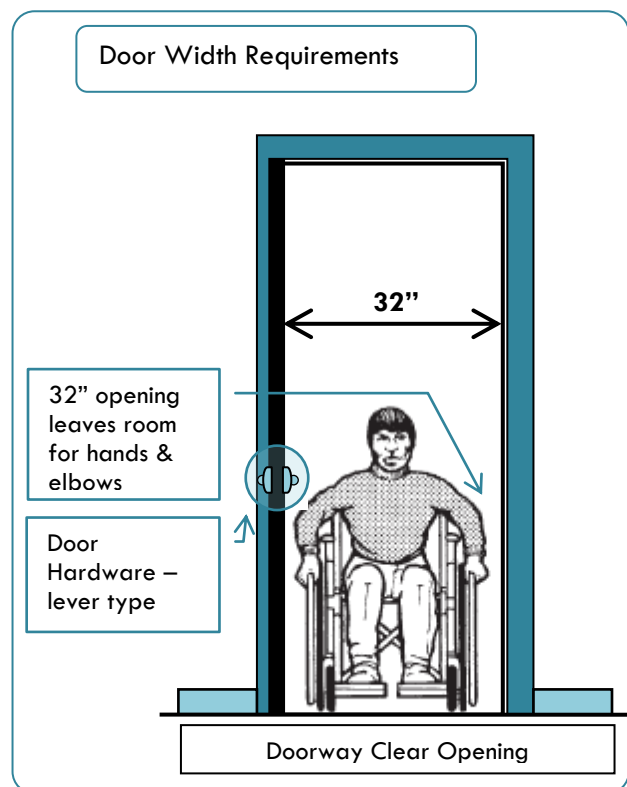

**32.8.13 DOOR TYPES (REFER TO PART 2 OF THIS GUIDELINE)**

**32.8.13.1 DOOR HARDWARE**

According to the ADAAG Manual (4.13.9\* **Door Hardware**) Door Hardware are handles, pulls, latches, locks, and other operating devices on accessible doors shall have a shape that is “easy to grasp with one hand” and does not require tight grasping, tight pinching, or twisting of the wrist to operate. Lever-operated mechanisms, push-type mechanisms, and U-shaped handles are acceptable designs. **Various types of hardware are acceptable although those that can be operated with a closed fist (levers, push bars) or a loose grip (pull handles) accommodate the broadest range of users.** Thumb turns, which are operated with simultaneous hand and finger movement, require a high degree of dexterity and coordination and are not recommended. When sliding doors are fully open, the hardware must be exposed and usable from both sides.

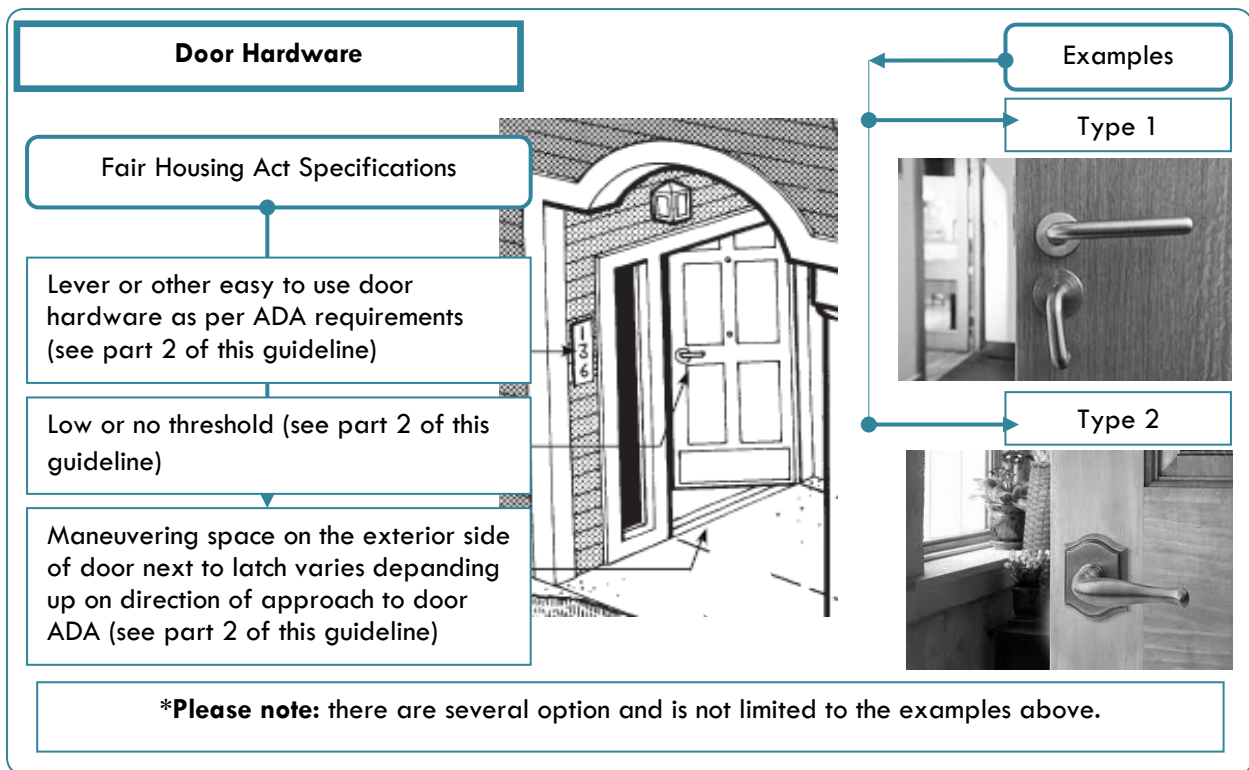

For Door Types refer to Chapter 404.2.7 Door and Gate Hardware of 2010 ADA Standards to Accessible Design.

### 32.9 ACCESSIBLE ROUTE INTO AND THROUGH THE COVERED UNIT

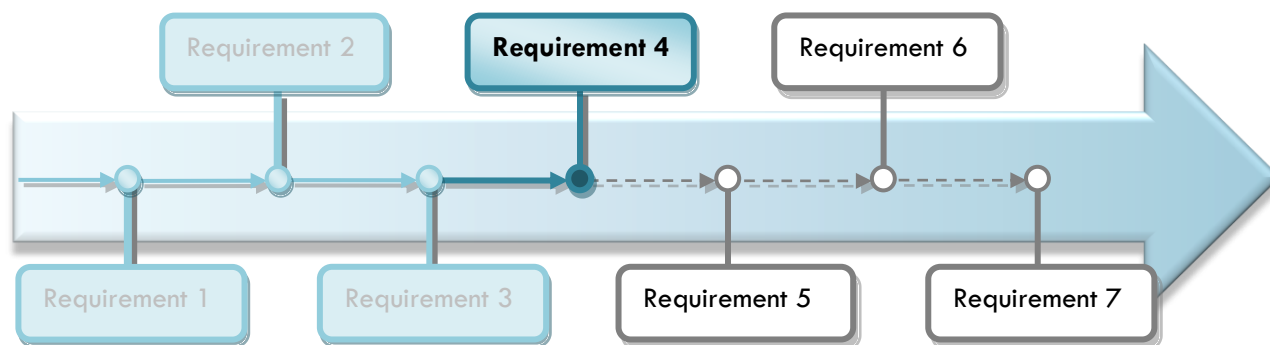

#### 32.9.1 BACKGROUND

The Fair Housing Accessibility Guidelines specify that an accessible route be provided into and throughout the entire dwelling unit. The accessible route must pass through the main entry door, continue through all rooms in the unit, adjoin required clear floor spaces at all kitchen appliances and all bathroom fixtures, and connect with all secondary exterior doors.

#### 32.9.2 THE ACCESSIBLE ROUTE MUST BE:-

- ♿ Sufficiently wide, and;
- ♿ Lacking in abrupt changes in level so residents with disabilities (and/ or their guests with disabilities) can safely use all rooms and spaces, including storage areas and, under most circumstances, exterior balconies and patios that may be part of their dwelling unit. See page 4.11 for exception at balconies and patios constructed of impervious materials.

An accessible route is not required into a basement or garage. However, doors from the interior of the dwelling unit to an unfinished basement or a garage attached to a single-story dwelling unit must be “usable”; see Chapter 3: “Usable Doors.” Providing an accessible route and a usable door in these circumstances will allow a resident to make later modifications, such as installing a ramp from the dwelling unit into the garage, thereby increasing usability of the unit.

#### 32.9.3 WIDTH

The 36-inch wide fully accessible route as described in Chapters 1 and 2 must connect with the clear floor space outside the primary entry door of each covered dwelling unit. As the accessible route passes into the unit it may be reduced to 32 inches minimum clear width at the door. Throughout the unit the accessible route must be 36 inches wide or wider, except as it passes through passage doors, where it may be reduced to 32 inches nominal clear width. See Chapter 3: “Usable Doors.”

#### 32.9.4 CHANGES IN LEVEL

Within single-story dwelling units (and on the primary entry level of multistory dwelling units in buildings with elevators) the maximum vertical floor level change is 1/4 inch, except when a tapered threshold is used, the maximum height is 1/2 inch. Even small abrupt changes of level in the surface of an accessible route pose a tripping hazard for many people and can be a significant



obstacle for people using wheelchairs. People who walk wearing braces and/or who have difficulty maintaining balance are particularly susceptible to catching their toes on small changes in level.

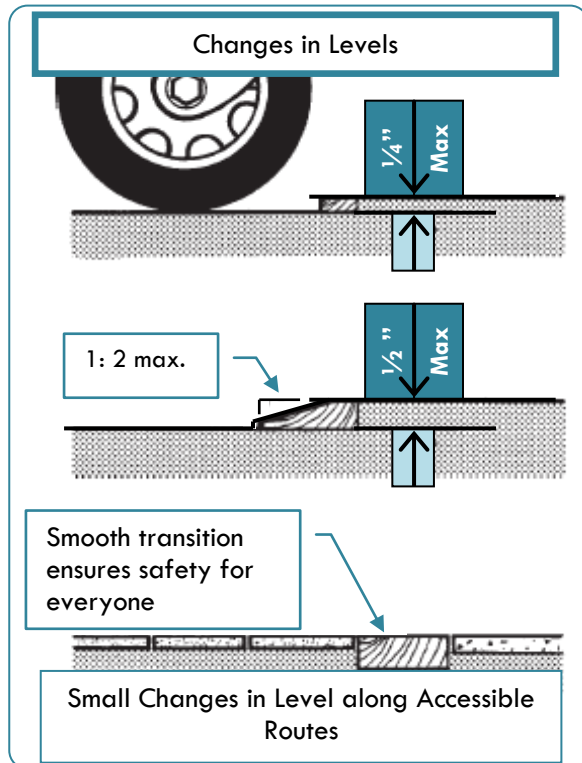

Small abrupt changes in level occur most frequently at floor material changes and at door thresholds. Within the interior of the dwelling unit, thresholds should not be used or they should be thin and installed flush with the flooring surface. If a threshold must be used, it must not have a level change more than 1/4 inch without being beveled or tapered. When a tapered threshold is used, the level change may be a maximum of 1/2 inch. If an interior door threshold represents a change in level greater than 1/2 inch, it must be ramped and must slope at 1 inch in 12 inches maximum (1:12). Thresholds at exterior doors are addressed in Part 2.

### 32.9.5 THRESHOLDS AT EXTERIOR DOORS

The concept of an accessible route is intended to ensure the maintenance of a continuous path of travel with no abrupt changes in level so people

with disabilities who use wheelchairs or scooters and those who walk are not impeded. However, changes in level are inevitable at exterior doors because thresholds and changes in level are needed to control and/or prevent water infiltration.

The Guidelines allow limited changes in levels at exterior doors along accessible routes and specify that thresholds at these exterior doors, including sliding door tracks, shall be no higher than 3/4 inch. The Guidelines further state that changes in level at these locations must be beveled with a slope no greater than 1:2.

**32.10 LIGHT SWITCHES, ELECTRICAL OUTLETS, THERMOSTATS, AND OTHER ENVIRONMENTAL CONTROLS IN ACCESSIBLE LOCATIONS**

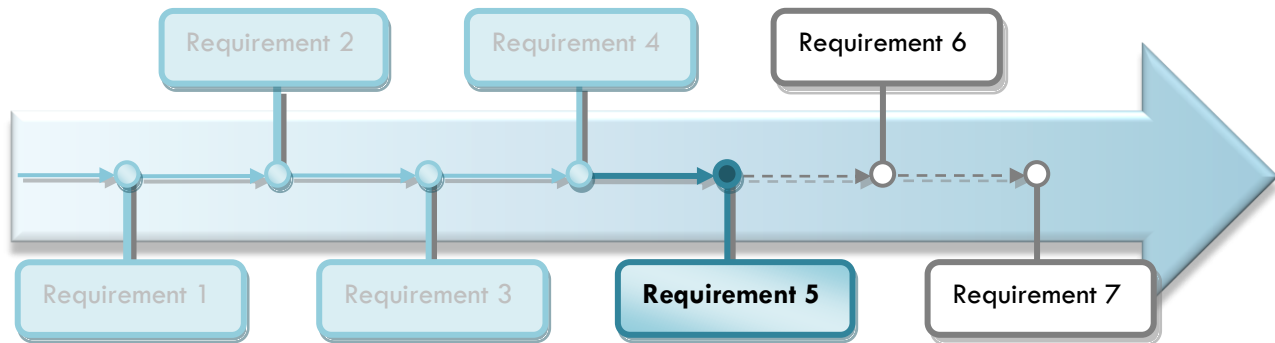

**32.10.1 BACKGROUND**

The ADA or ANSI specifications for accessible controls and operating mechanisms require a clear floor space to allow an approach by a person using a wheelchair, specify the height of the operable portion of the control, and require little or no force be exerted to operate the control. The Fair Housing Accessibility Guidelines (the Guidelines) do not require controls to be fully accessible but specify that light switches, electrical outlets, thermostats and other environmental controls, which are operated on a regular or frequent basis in the daily use of a dwelling unit, be in accessible locations.

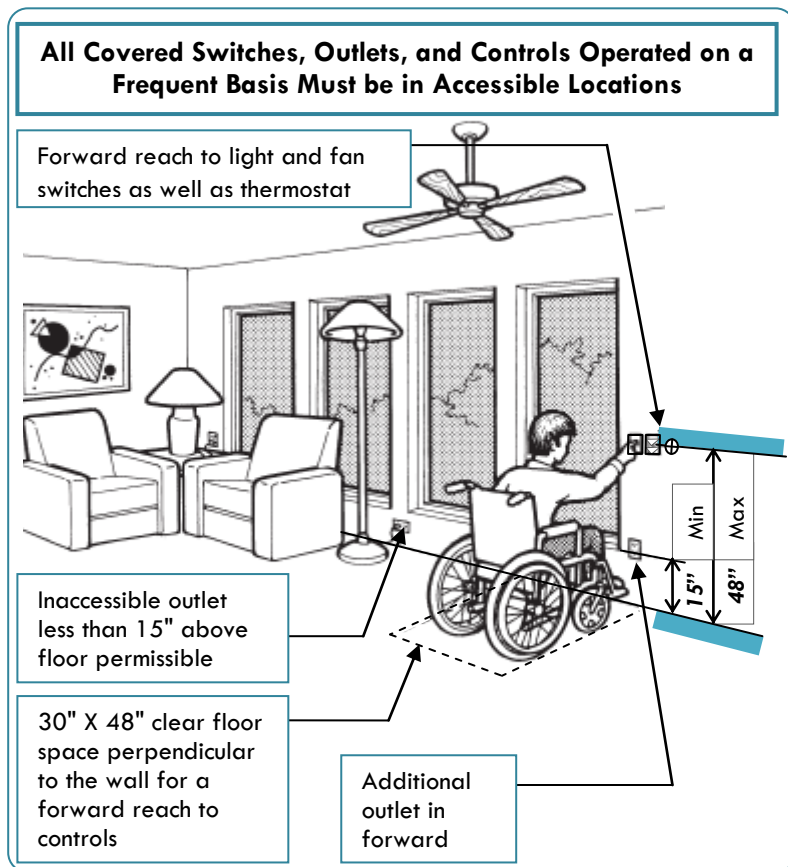

The Guidelines' specifications for accessible locations, based on the ADA Standard, address where to position controls and outlets to be within the reach range of a seated user. Force and type of motion required to operate controls are not covered by the Guidelines.

**32.10.2 ENVIRONMENTAL CONTROLS**

**Environmental controls** such as thermostats and other heating, air-conditioning, and ventilation mechanisms including ceiling fans and electrically operated skylights must be positioned in accessible locations, as must **light switches** and **electrical outlets** for each room. All these covered controls and outlets must be in accessible locations, with a few exceptions:-

**32.10.3 EXCEPTIONS**

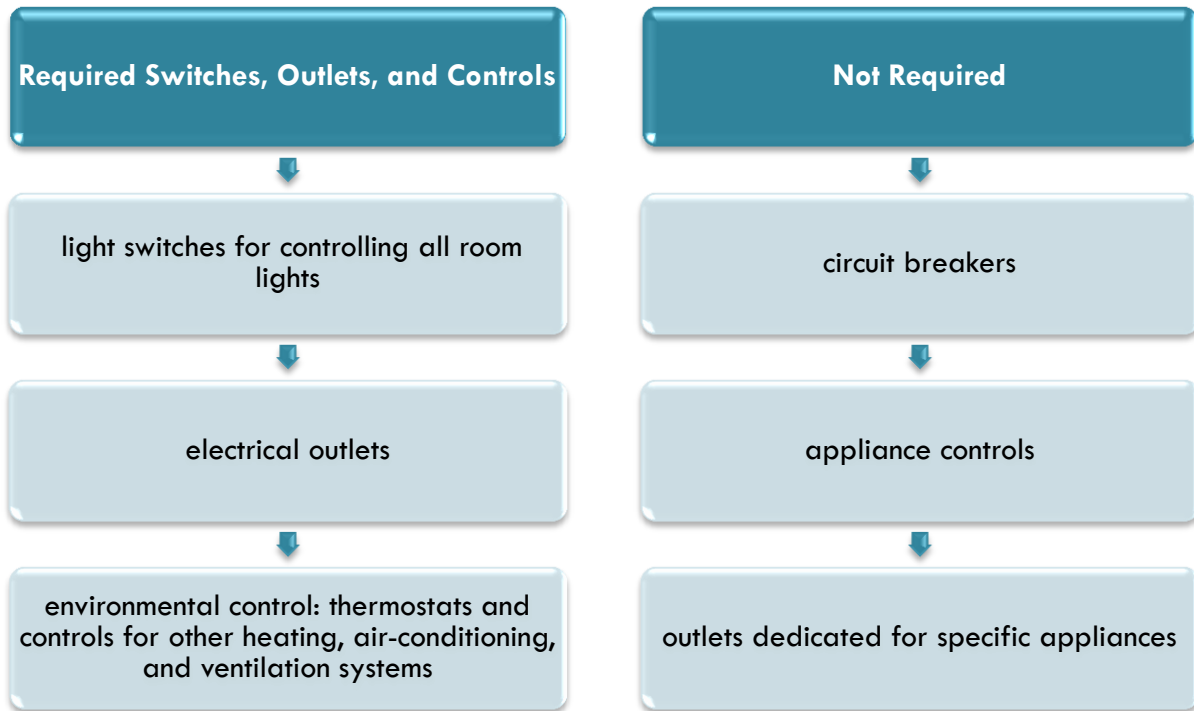

**32.11 REINFORCED WALLS FOR GRAB BARS**

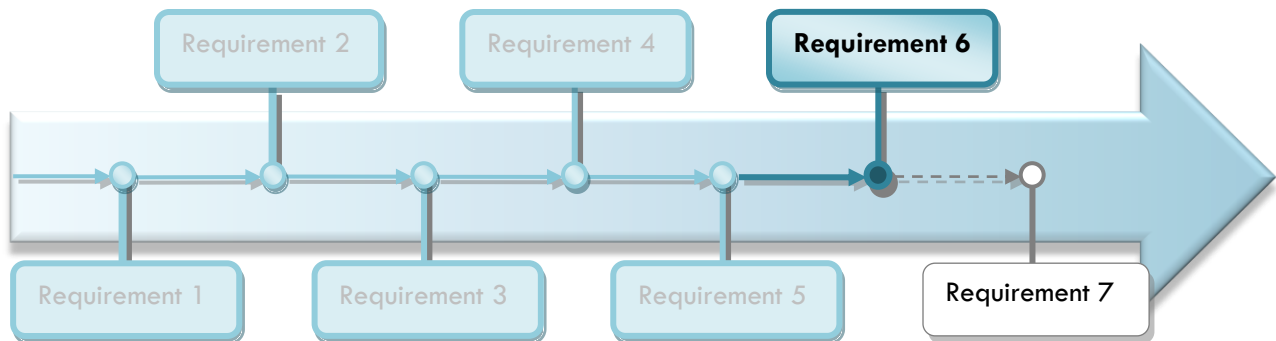

**32.11.1 BACKGROUND**

The Fair Housing Accessibility Guidelines (the Guidelines) do not require that grab bars be installed in bathrooms. However, the Guidelines do require that bathroom walls be sufficiently strong to allow for later installation of grab bars for resident use. This requirement applies to all bathrooms, and also to powder rooms when the powder room is the only toilet facility on the entry level of a multistory dwelling unit.

Grab bars are critical for many people with mobility impairments to be able to safely transfer on and off the toilet. Safety for everyone is greatly increased by the addition of grab bars at bathtubs and showers.

The Guidelines do not prescribe the type or size of grab bars, nor the structural strength they must exhibit. The Guidelines state only that the necessary reinforcement must be placed “to permit the later installation of appropriate grab bars” (refer to part 2 of this guide).

**32.12 USABLE KITCHENS AND BATHROOMS**

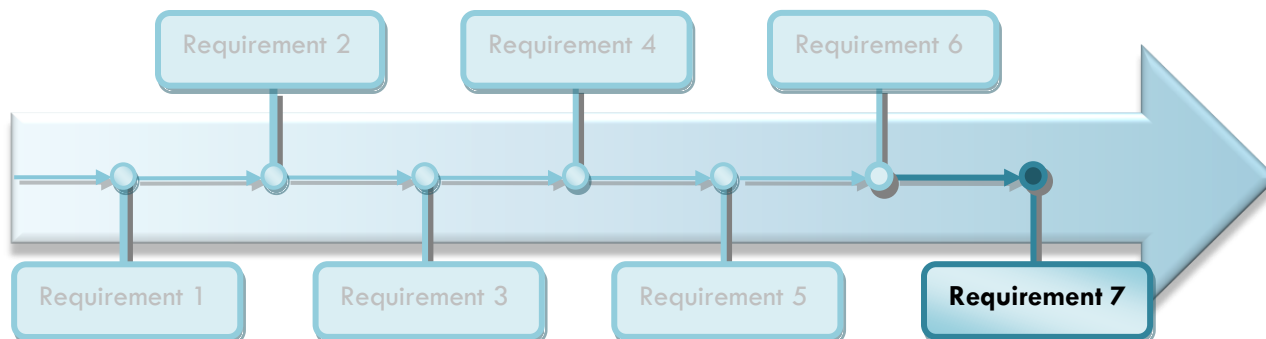

**32.12.1 BACKGROUND**

Kitchens that comply with the Fair Housing Accessibility Guidelines (the Guidelines) can be

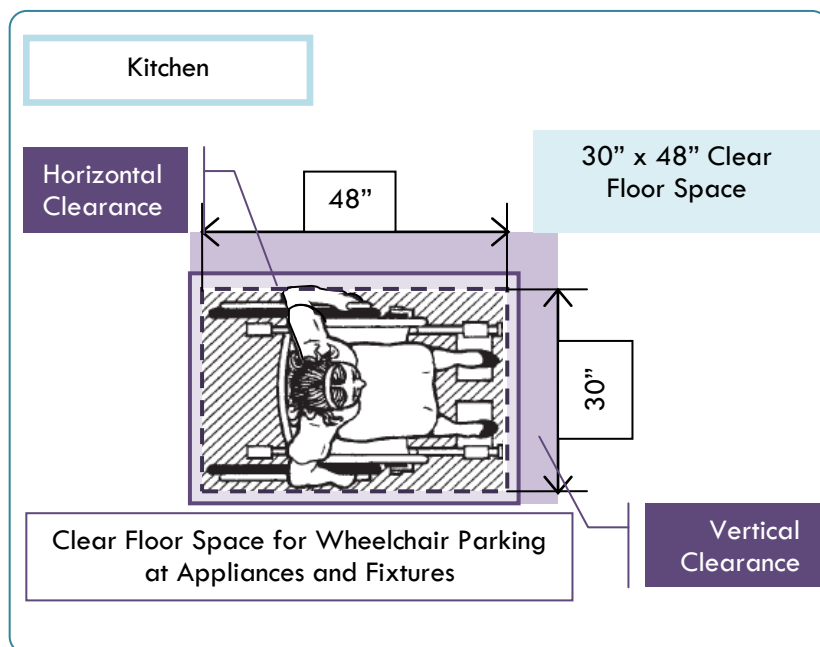

designed to look and function like conventional kitchens typically found in multifamily housing. The Guidelines specify that three specific requirements must be provided to allow people who rely on mobility aids to “use” the kitchen. “Usable” kitchens, as specified in the Guidelines, are not necessarily “accessible” kitchens, but they do provide maneuvering space for a person who uses a wheelchair, scooter, or walker to approach and operate most appliances and fixtures.

**32.12.1.1 CLEAR FLOOR SPACE AT RANGES, COOK-TOPS AND SINKS**

Unless knee space is provided, space to execute a parallel approach must be provided at ranges, cooktops, and sinks. The clear floor space in this parallel orientation allows the wheelchair user to make a close side approach permitting safer and easier reach to controls and cooking surfaces. A forward approach, on the other hand, is difficult and unsafe, especially when controls are located at the back, because it requires seated users to lean forward over their feet and knees to reach not only hot pots and pans but the controls as well.

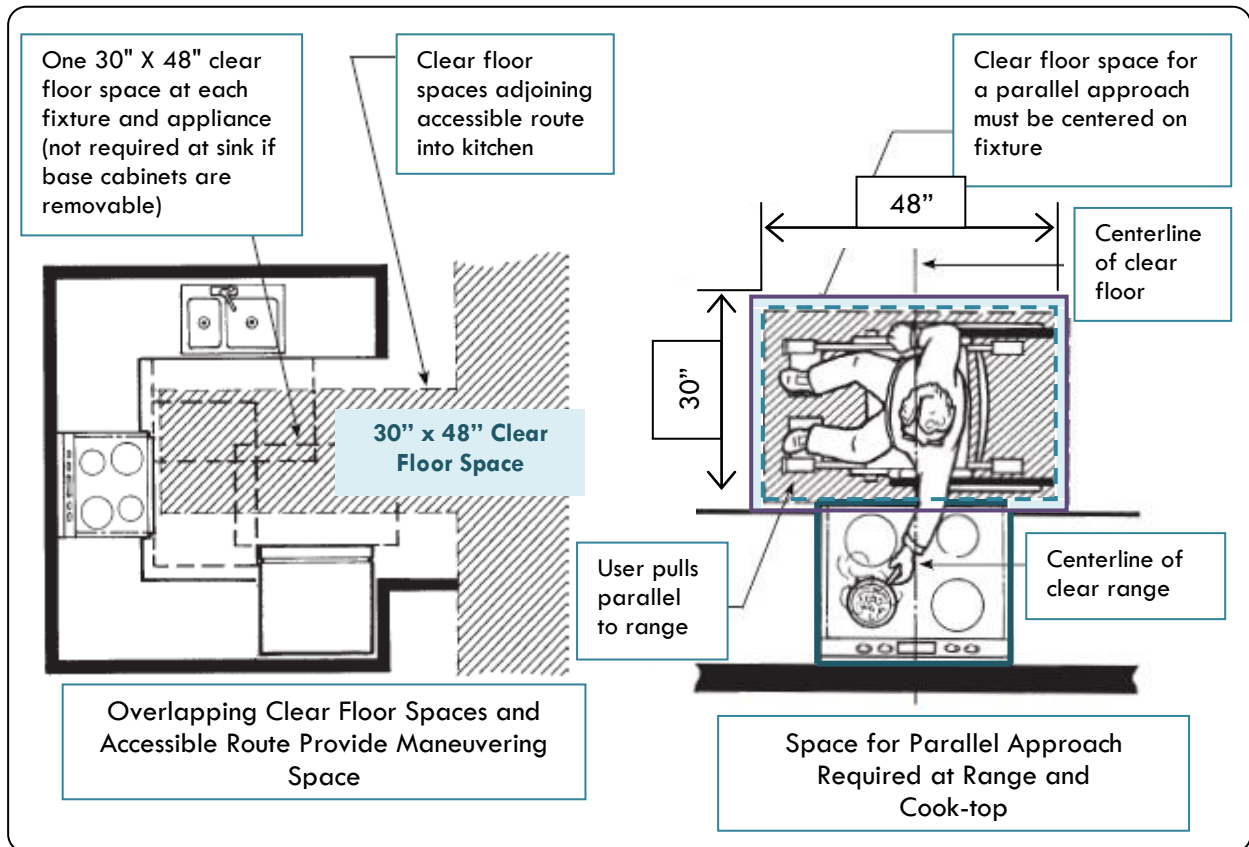

**32.12.1.2 CLEARANCE BETWEEN COUNTERS AND ALL OPPOSING ELEMENTS**

The Guidelines require a clearance of at least 40 inches between all opposing base cabinets,

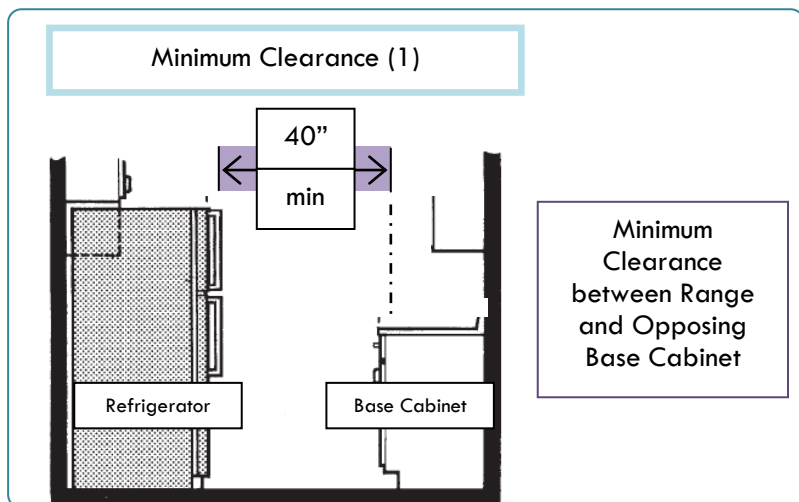

countertops, appliances, and walls. The 40-inch clearance is measured from any countertop or the face of any appliance (excluding handles and controls) that projects into the kitchen to the opposing cabinet, countertop, appliance, or wall.

Refrigerators vary greatly in depth and may extend up to eight inches beyond cabinet faces. Standard free-standing and drop-in ranges may project up to three

inches. Appliance depths (excluding door handles) must be included when calculating the 40-inch clearances.

**32.12.1.3 NARROW KITCHENS**

In a narrow kitchen the 40-inch minimum clearance provides an additional five inches on either side of the required clear floor space of 30 inches x 48 inches at each fixture or appliance, so a user in a wheelchair can maneuver as close as possible to appliances or fixtures. A narrow kitchen such

as the one shown to the right meets the Guidelines and is usable, but may be difficult for many people using wheelchairs. Its narrow corridor design requires a user in a wheelchair to exit the kitchen to turn around.

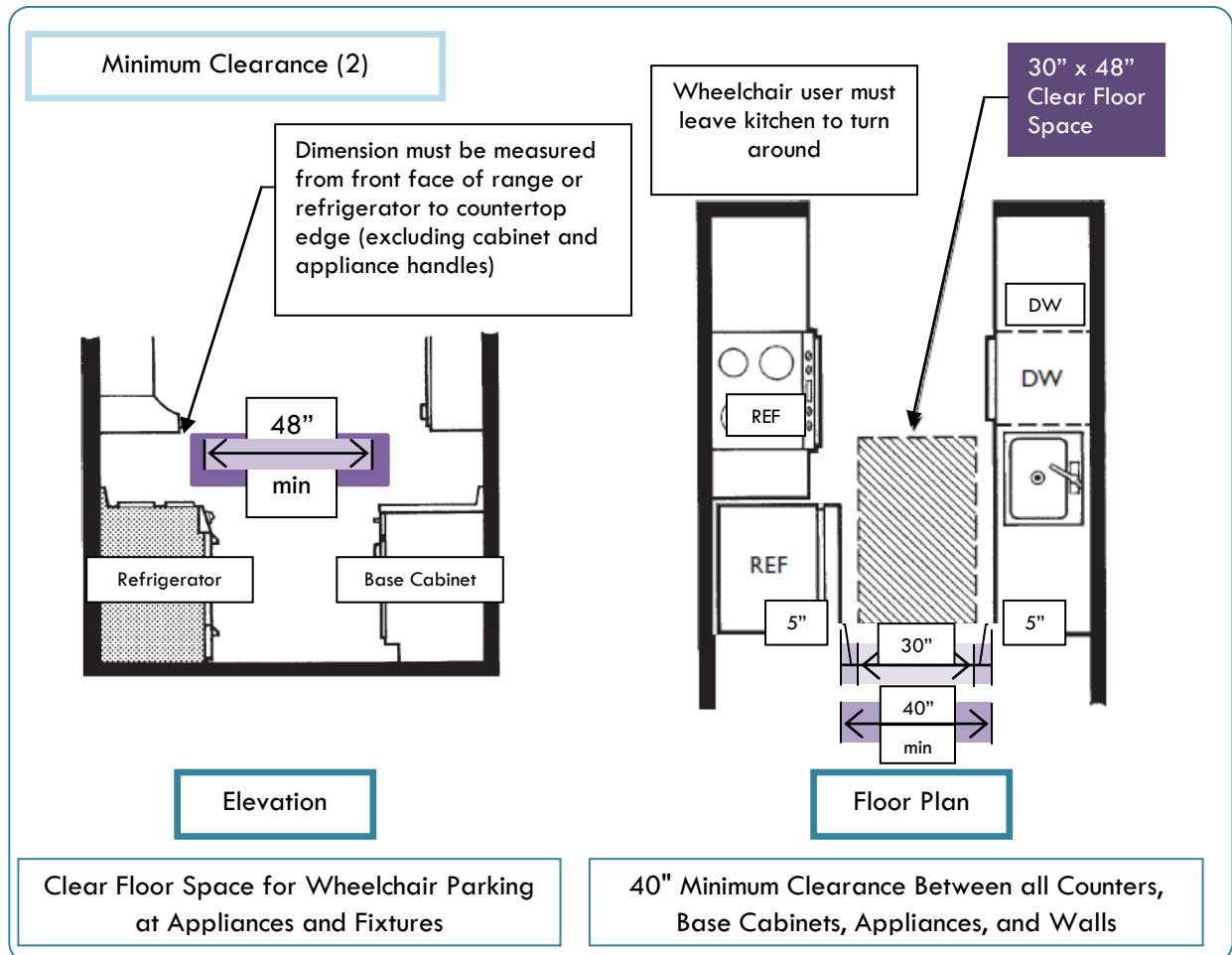

#### 32.12.1.4 KNEE SPACE AND PIPE PROTECTION

Where knee spaces are provided below sinks and cook-tops, protecting seated users from burns and abrasions is strongly recommended. While the Guidelines do not specify such protection, the two most common design standards on accessibility (ANSI A117.1, 1986 and UFAS) require that the bottom of cook-tops and sink supply lines and drain pipes be insulated or enclosed. Many people who use wheelchairs or scooters have limited sensation in their legs and cannot feel that they are touching a hot pipe or sharp edge and may be unaware that a serious injury has occurred. In addition, the need for protection from burns is an important safety consideration for all persons.

The dimensions for the knee space itself must be 30 inches wide (minimum) and should be 27 inches high (minimum). Since there is no specific ANSI figure delineating the requirements for knee space clearance beneath sinks or cooktops in dwelling units, the accompanying illustrations may be used as guidance when providing knee space beneath removable base cabinets.

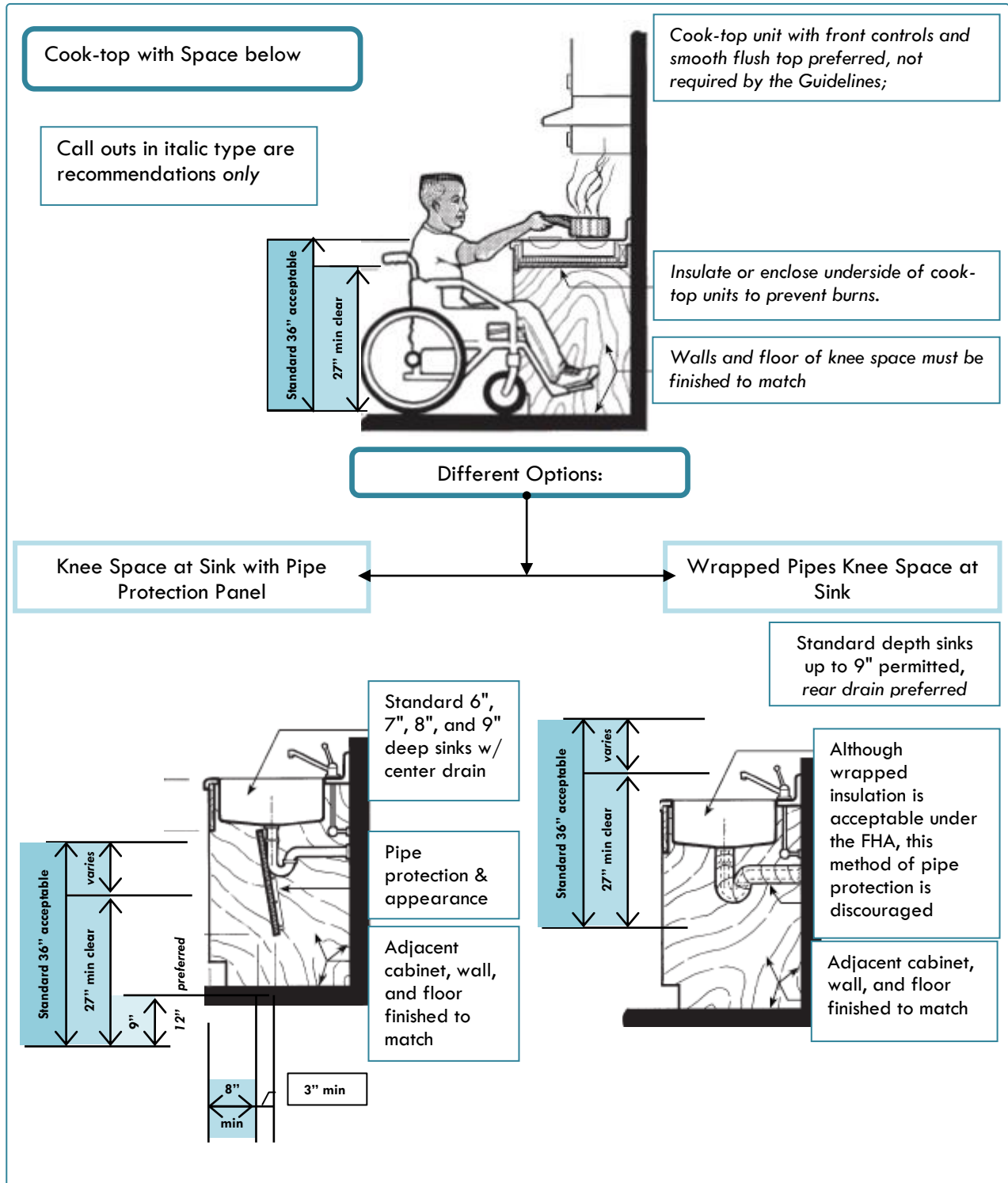

### 32.12.2 BATHROOMS

The Fair Housing Accessibility Guidelines (the Guidelines) provide specifications for bathroom design that make it possible for people who use mobility aids, and who, heretofore, could not even get into conventional bathrooms in multifamily housing, to now use such facilities. Though not fully accessible, when designed to comply with the Guidelines, these “usable” bathrooms provide a person who uses a wheelchair or scooter or who may use a walker or other mobility aid with a

bathroom that has enough maneuvering space to allow the person to enter, close the door, use the fixtures, and exit. In some cases, a resident with a disability will find it necessary to make additional modifications to meet his or her specific needs

### 32.12.2.1 BATHROOM REQUIREMENTS

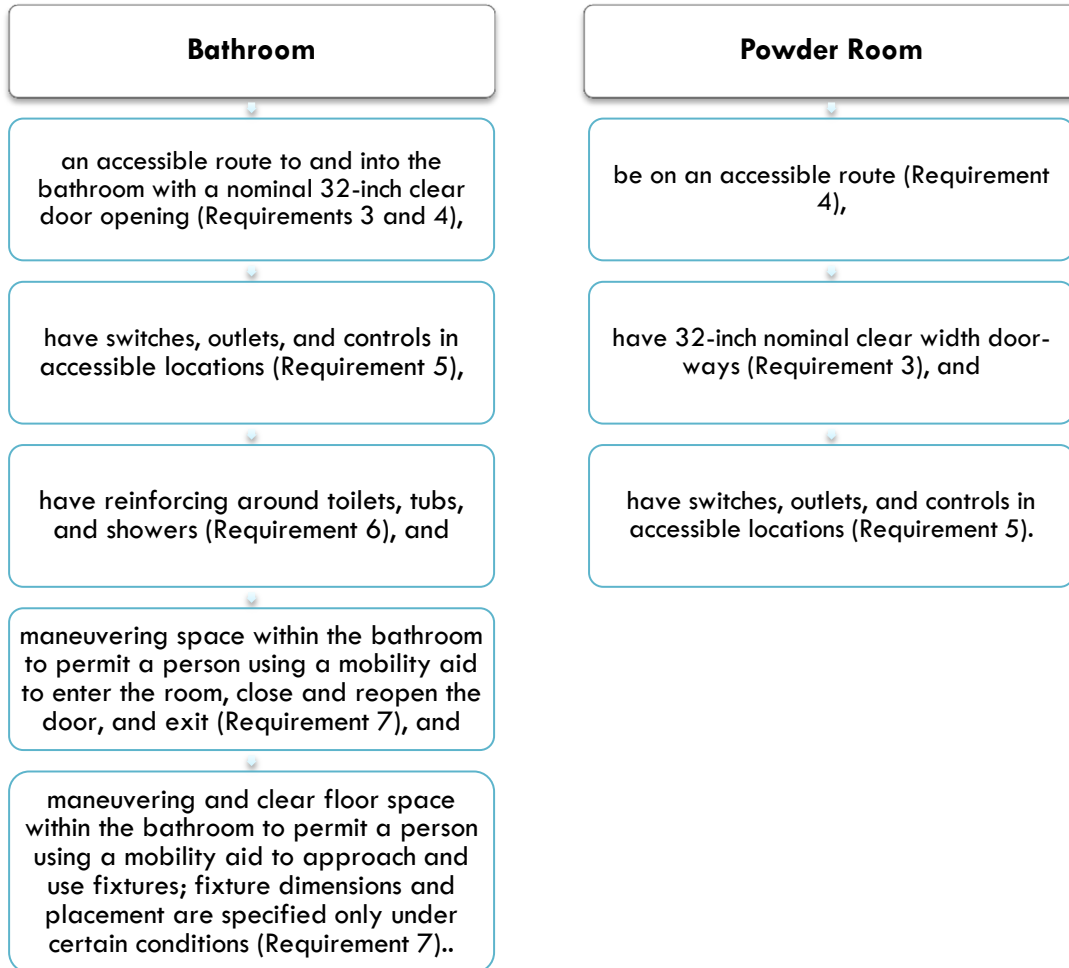

### 32.12.2.2 MANEUVERING SPACE IN BATHROOMS

**A 30-inch x 48-inch clear floor space outside the swing of the door as it is closed.** In bathrooms where the door swings out of the room all the clear floor spaces at fixtures still must be provided. In addition, the user must be able to reopen the door to exit.

The maneuvering space necessary for usable bathrooms is thus made up of the combination of the designated clear floor spaces at fixtures and the presence of clear floor space outside the swing of the door. Clear floor spaces may overlap each other and the maneuvering space also may include knee or toe space under lavatories or toilet bowls.



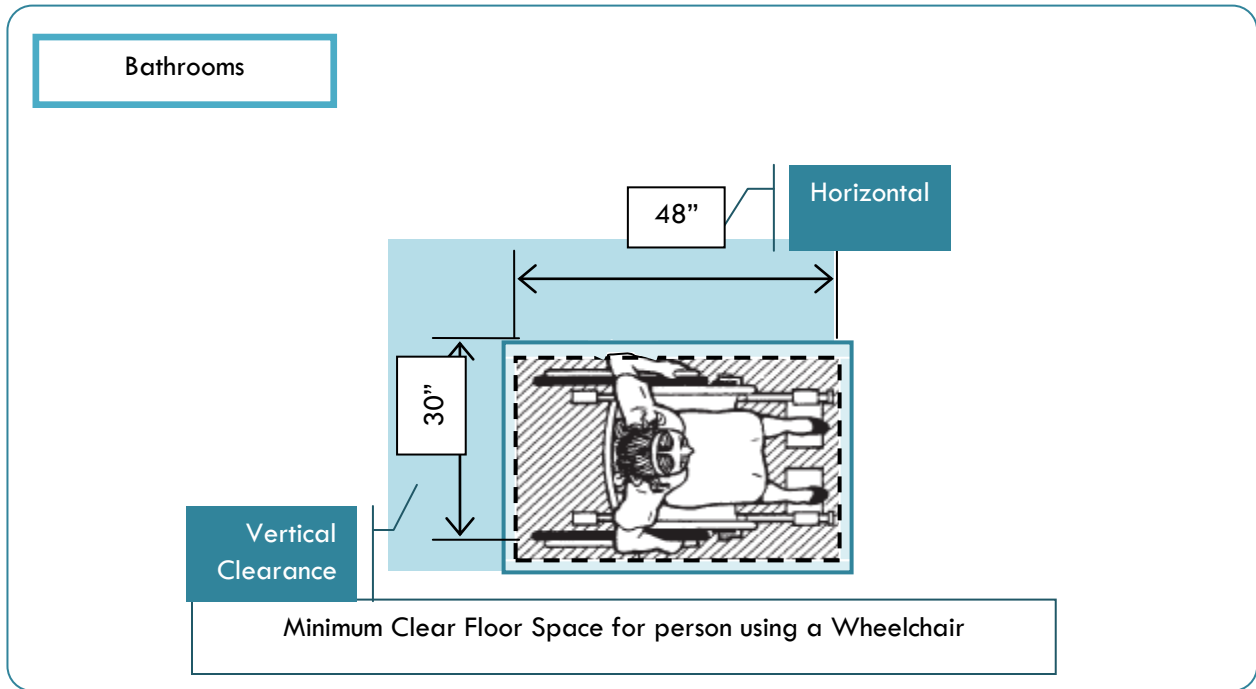

 For all other specification refer to **Chapter 8: Plumbing Elements & Facilities**

Note: Accessible Requirements for Single Dwellings see advisory section in Appendix D

32.12.2.3 ONE EXAMPLE OF AN ACCESSIBLE DWELLING UNIT

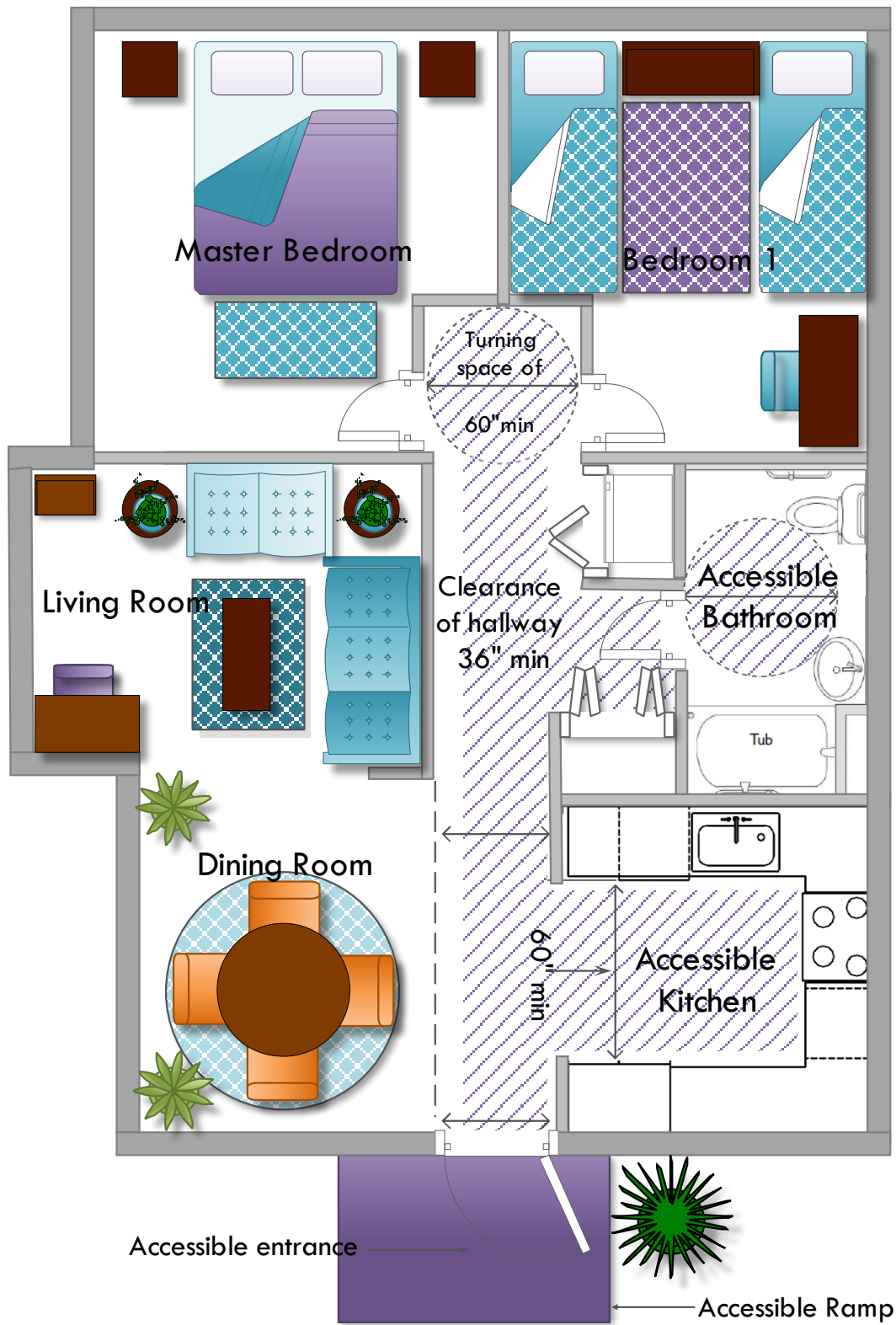





---

## **33 PRECAUTIONS DURING BUILDING OPERATIONS**

---

### **33.1 PROTECTION OF SITE**

Where the construction operations on a site are deemed by the Building Official to pose a danger to the public as a result of proximity to a highway or estate road or other public area, or due to the nature of the building operations or the length of time taken to perform the works, then the Building Official may require a protective barrier be erected. Such a barrier shall be a minimum of 4 feet in height on the side facing away from the building site and shall be constructed as to withstand a minimum load of 200 lb applied at any point and in any direction. The barriers shall not allow the passage of a 4" diameter sphere.

### **33.2 ADJOINING PROPERTIES**

All adjoining public and private property shall be protected from damage by construction operations. Any damage generated by such activities will have to be repaired at the expense of the owner and/or developer.

### **33.3 STORAGE OF MATERIALS**

All materials and equipment associated with the construction operations shall be stored on the owner's property.

### **33.4 DUST AND MATERIAL CONTROL**

The site shall be controlled so as not to result in the emission of dust, soil, dirt, stone, or other small particles or materials to adjoining properties.

### **33.5 RUNOFF**

Drainage and surface runoff from the property shall not impact adversely on adjacent properties, public or private roads. This shall include the runoff of loose soil and fill onto adjacent properties and roads, both during and after construction operations. If deemed necessary by the Building Official, drainage trenches and drainage pits shall be constructed to control and dispose of runoff.

### **33.6 SAFETY OF WATER TANK EXCAVATIONS**

All excavations for tanks shall be kept covered at all times until the permanent flooring has been installed over them. The covers shall be suitable to withstand a minimum point load of 300 lb. Alternatively, a barrier in accordance with Section 34.1 shall be erected to totally enclose the tank excavation and prevent accidental falls.

### **33.7 PREVENTION OF STANDING WATER**

No standing water shall be allowed to accumulate in partially finished water tanks or the like, due to the potential occurrence of mosquito breeding.

**33.8 BUILDING WORKS ON ESTATE ROADS****33.8.1 EXCAVATIONS IN ROADS**

Where as part of a building operation it is necessary to excavate an estate road, the excavations shall be carried out expeditiously in accordance with good engineering practice. After excavation the surface shall be made good to the satisfaction of the Building Official.

**33.8.2 OBSTRUCTIONS IN ROAD**

No part of an estate road shall be used in connection with the construction, alteration, renovation, repair or demolition of any building except with the written permission of the Building Official.

**33.8.3 BRACING**

All excavations shall be adequately braced and supported to prevent danger to any person in the excavation or any land adjacent to it.

**33.8.4 BARRIERS**

Any excavation shall be adequately fenced to the satisfaction of the Building Official to a height of at least 3 feet and enclosed until it is filled up.

**33.8.5 LIGHTING OBSTRUCTION**

Any person causing any building materials, equipment, excavation, hoarding or any other obstruction to be placed in an estate road, shall provide suitable red or orange flashing lights in safe positions upon or near the obstructions in both directions. These lights shall be operated from sunset to sunrise, while such obstructions remain in place.

**33.9 BUILDING WORKS ON PUBLIC ROADS**

Where obstructions or excavations are proposed in highways/public roads, approval must be obtained in advance from the Ministry of Public Works.

**33.10 HEALTH & SAFETY**

All construction operations shall take place strictly in accordance with the Occupational Safety and Health Act 1982 or any subsequent amendments. Guidance documents on the legislation relevant to construction sites can be obtained from the Department of Health.

## 34 APPENDIX A: CONSTRUCTION DOCUMENTS FOR BUILDING PERMIT SUBMISSION

**A.1.1 Scope:** In accordance with section 2.5 this Appendix contains a detailed listing of the information the *Building Official* requires to process the building permit applications. The plans received for building control review need to be working drawings – that is, the drawings from which the contractor will be building. Once the permit is issued, the plans become the approved drawings which are required to be kept on the site by the contractor during construction. This list should not be taken as all encompassing; it may be necessary for the Building Official to ask for more detail if an unusual circumstance arises. Similarly, there will be instances when all of the information listed is not required due to the minor nature of the work. If in doubt, contact the Plans Examiner for clarification prior to making a submission. This list should serve as a checklist to be reviewed prior to submission of the building permit application.

**A.1.2 Information Required for Building Permit Submissions:** All drawings shall be drawn to scale and adequately dimensioned to enable the building to be constructed. In all cases, the plans must show a differentiation between the existing and proposed work (e.g. hatching, shading, highlighting). The submission of false and/or inaccurate information documents for approval may invalidate any permit that is issued.

**a) Location Plan:** A location plan at a scale of 1:2500 shall be provided. It shall show the precise location of the property, outlined in red, in relation to main roads and private roads.

**b) Site Plan:** This shall be drawn to a recognizable scale not less than 1:250 (1"=20"). It shall show the size and location of all new and existing construction and shall show the following information:

- Site cross sections at locations of maximum change of grade;
- distances from lot lines;
- legal boundary lines;
- North arrow;
- location of all existing underground services, (electricity, telephone, cable TV, water and sewer lines), driveway access and parking;
- existing and finished grades;
- surveyed contour lines at 1 metre intervals for sloping sites;
- ground floor levels of the new and existing construction;
- location, depth and dimensions of cesspit, including structural details;
- location of proposed rock cuts, retaining walls and barriers;
- location of proposed walls and fences;
- location and height of required barriers and guardrails;
- details of site drainage including drainage soakaways, trenches, boreholes and berms;
- location and size of existing water tanks;
- location and extent of proposed site excavation or filling including the gradient of slopes; and,
- location of proposed swimming pools and backwash pits.

**c) Foundation Plans:** These shall be to a scale of not less than 1:100 (1/8" = 1'), and shall show:

- Size of each foundation;
- levels of the slabs, grade beams, etc;
- details of reinforcing, including cover and lap lengths;
- approximate locations of steps in the strip footings;
- size of the foundation walls and reinforcing details;
- location and size of columns;
- location and size of water tank;
- chimney foundations; and,
- location of excavated and unexcavated areas within the building footprint

**d) Floor Plan:** A floor plan, to the same scale as the foundation plan and at each floor level of the building, shall show:

- Finished floor levels;
- room size, arrangement and description;
- wall types and sizes (including fire separation walls);
- stairs;
- fireplaces;
- direction of span of all reinforcing of concrete slabs or timber floor joists;
- location of support beams below;
- window and door sizes and locations; and,
- size and reinforcing of all lintels over openings.

In the case of changes to existing buildings, the floor plan shall also show:

- Existing layout of the floor with details clearly identifying the areas of walls, partitions to be removed; and,
- identification of which walls and partitions are load bearing or non-load bearing.

**e) Elevations:** These shall be to the same scale as the floor plans where possible, and shall show a view from each side of the building for new buildings, or in other cases, from all sides that will be affected by the development. They shall include the following information:

- Orientation of each elevation according to the direction it faces;
- location of windows and doors;
- roof pitch;
- finished floor levels, eave level and overhang;
- finished grade and existing grade;
- roof vent sizes and locations; and,
- chimney heights.



**f) Building Sections:** These shall be to a scale of not less than 1:50 (1/4" = 1'), and a minimum of two cross sections of the building at right angles to each other shall be provided, which shall show:

- Foundation details;
- waterproofing or damp-proofing, vapour barriers, if necessary;
- wall details (thickness, bond beams, wall plates, lintels);
- floor details (thickness, type of metal deck, reinforcing, joist sizes);
- roof details (rafter size and spacing, collar tie connections, ridge boards, roof type, roof pitch);
- stairs (treads, risers, landings, headroom, waist, reinforcing, handrail);
- fireplace construction (flue, firebox, hearth, lining);
- chimneys (foundation, wall lining); and,
- ceiling heights (show beam projection into room space).

In addition, for sloping sites, separate sections shall be shown through the following items:

- Retaining walls on the site (foundation details, reinforcing, wall size guardrails); and,
- cesspits (size, slab thickness, reinforcing, access, adjacent ground levels, high water level, boundary lines).

**g) Roof Framing Plan:** A roof framing plan shall be shown to the same scale as the floor plans. It shall provide the following information:

- Size and spacing of all rafters, collar ties, trusses;
- details of special roof beams required over large spans;
- wall plates and connections to the bond beam;
- hip and valley rafter details;
- connection details of collar ties to rafters; and,
- chimney location and size of flue.

**h) Roof Plan:** A roof plan to the same scale as the floor plan shall be provided, and shall show:

- The total area of the roof catchment;
- roof drainage;
- location and size of drain pipes;
- location and size of roof ventilation; and,
- any equipment intended to be installed on the roof.

**i) Electrical Plan:** An electrical plan for each floor to the same scale as the floor plan shall be provided, and shall show all new and existing works as follows:

- Location and details of all outlets, fixtures, switches, GFCI's, panelboards, meters, and controls;
- location and type of smoke/heat detectors and any notes about programming;

- single line diagram plus total volt-amp rating of the service entrance proposed and protection requirements;
- grounding and bonding specification;
- mechanical ventilation system and pump supplies;
- any other significant electrical loads such as hot tubs, air conditioning systems, fans, etc;
- a panel schedule for all new panels, with demand calculations per panel and cable sizes;
- complete electrical drawings for swimming pools and hot tubs, including all pump, lighting and grounding/bonding specifications;
- complete electrical drawings for solar or wind power installations, including specification of devices, protection devices, cable sizes, bonding, battery systems, signage and grid tie calculations; and,
- complete electrical drawings for back-up generator sets, including unit specification, supply calculations/load shed details, Automatic Transfer Switch details, grounding details and environmental specifications for emissions, noise and exhaust.

The electrical details can be shown on the building floor plans for small uncomplicated projects if space allows, provided sufficient clarity of the drawing is maintained.

**j) Plumbing Plan:** A plumbing plan for each floor to the same scale as the floor plans shall be provided, and shall show all new and existing works as follows:

- location of all sinks, wash basins, lavatories, bath tubs, showers, water heaters,
- washing machines, and other appliances,
- location and size of plumbing and drainage lines showing fresh water, waste water, sewer lines, seal traps, rain water leaders, floor and site drains, and
- location and size of vent piping.

The plumbing plans can be shown on the building plans and/or site plan, for small uncomplicated projects if space allows, provided sufficient clarity of the drawings is maintained. Where the site plan is used for plumbing purposes, the scale of the drawing shall be not less than 1:100 (1/8" = 1').

**k) Mechanical Plan:** A mechanical plan for each floor to the same scale as the floor plans shall be provided and shall show all new and existing works as follows:

- Location of all mechanical equipment;
- location and size of all ventilating systems;
- location of all ductwork;
- location of all refrigerant piping; and,
- location and size of all condensate drains.

The Building Official shall require that calculations demonstrating compliance with IMC Chapter 11 be submitted for all refrigeration systems containing more than 6.6 pounds (3kg) of refrigerant along with the drawings.

Calculations shall demonstrate adequate ventilation to meet minimum code requirements including make-up air.

The mechanical plans can be shown on the building plans and/or site plan, for small uncomplicated projects if space allows, provided sufficient clarity of the drawings is maintained. Where the site plan is used for mechanical purposes, the scale of the drawings shall be not less than 1:100 (1/8" = 1').

**l) Energy Efficiency Specifications:** Specifications for energy efficiency measures shall be submitted with sufficient clarity to indicate the location, nature and extent of the work proposed, and show in sufficient detail pertinent data and features of the building, systems and equipment. The energy efficiency specifications shall include, but are not limited to, detailed plans and data for the following:

- Insulation materials and their R-values;
- Fenestrations SHGCs;
- Mechanical system design criteria;
- Mechanical and service water heating system and equipment types, sizes and efficiencies;
- Equipment and systems controls;
- Fan motor horsepower and controls;
- Duct sealing, duct and pipe insulation and location; and,
- Lighting fixture schedule with wattage and control narrative.

The energy efficiency specifications can be shown on the building plans provided sufficient clarity of the drawings is maintained.

**m) Specifications:** These shall identify the methods of construction for each different type of material and system being used on the project in sufficient detail to enable the contractor to build it, and the inspector to check it for compliance with the plans and the code. Examples of materials are concrete, masonry, timber, and steel; and of construction systems are floor, walls, roofs, electrical, plumbing and fire protection systems. For small projects, the specifications may be placed directly on the building permit plan documents themselves.

## A 2.1 REVISIONS/AMENDMENTS

In accordance with section 2.6.8, amendments may be submitted for projects that have already been issued a building permit. The following conditions shall be followed when submitting amended drawings:

- a) All revisions need to be clearly bubbled/highlighted to identify the areas that have been changed.
- b) A short description of the revisions shall be placed in the title box of the drawing.
- c) A "Plan Revision/Additional information Form" will need to be completed before the Front Desk staff will accept any amended drawing or additional information.

- d) As a general rule the “red marking” of drawings once they have been submitted, is not acceptable.
- e) Any revised drawings, except for those requested from the Building Official for clarification of an existing application, any be charged a fee in accordance with the Government Fee Regulations. Additional processing fees will be incurred if the revisions are substantial and/or include an increase in floor area.
- f) Where revisions are made that require planning permission, a separate planning application shall be made.

**35 APPENDIX B: NAIL FASTENING SCHEDULE**

**B.1.1 Scope:** This appendix lists the nail fastening connections used in the structural members described in other sections of the code. Table B-1 details the fixing requirements.

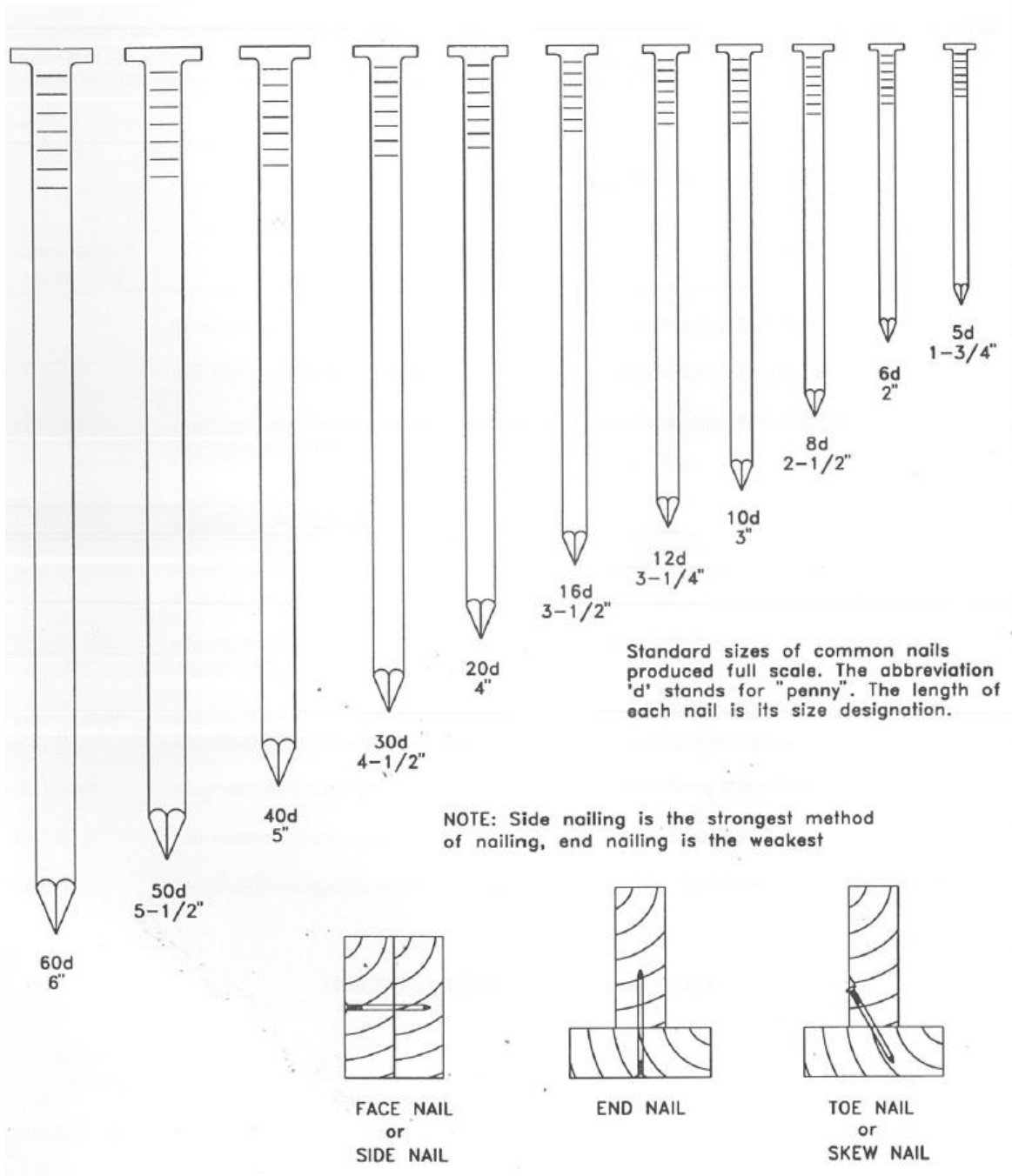

Figure 35-1: Typical Nail Types and Sizes

**B.1.2 Material:** Nails shall be constructed of galvanised steel, stainless steel or brass.

**B.1.3 Penetration:** Nails shall penetrate a minimum of one-half the length of the nail into the member that is being fastened into.

**B.1.4 Pre-drilling Holes:** Holes may be predrilled for nails as long as the size of the pilot hole does not exceed 80% of the diameter of the nail.

**B.1.5 Spacing of Nails:** The minimum spacing of nails shall be in accordance with Table B-3

**B.1.6 Toe Nails:** Toe nails (skew nails) shall be driven at 30° to the member and started one-third of the length of the nail from the end of the member.

**B.1.7 Nail Designation:** The nails are designated in terms of the penny weight (d). The actual sizes of the nails are detailed in Table B-4 and Fig B-1 for common wire nails

Building Member	Nail Size	Number and Location
<b>Floor Construction</b>		
Floor joist to stringer or bond timber	16d	2 toe nail
Lapped joists to stringer or bond timber	16d	2 side nails either side
Blocking between joists	16d	2 end nail
Herringbone strutting to joists	8d	2 toe nail
Curtailed joists to header when half housed	16d	2 end nail
Subfloor to joists to (up to ¾" thick)	8d#	6" c/c side at edges 12" c/c side at intermediate
Subfloor to joists (up to 1 ¼" thick)	10d#	6" c/c side at edges 6" c/c side at intermediate joists
<b>Roof Construction</b>		
Rafter to wall plate**	20d	2 toe nail
Lapped joint in rafter over support	16d	2 side nails either side
Rafter to ridge plate	20d	2 toe nail or end nail + 1 8d
Jack rafter to hip or valley	20d	2 end nail or 3 toe nail
Valley Rafters to wall plate	20d	2 toe nail + 1 8d
Hip rafter to wall plate	20d	2 toe nail

**Table B-1: Nail fastening Schedule**

**Note:**

- End nails are driven into the end grain of a piece of timber.
- Side nails are driven into the side of a piece of timber and form the strongest connection.
- Toe nails (skew nails) are driven at an angle to the side of a piece of timber.
- \*\* For the connection of lightweight roofs or unenclosed flat roofs, hurricane clips must also be used in accordance with chapter 10.
- # For the fastening of timber subfloor, the use of woodscrews instead of nails is permitted. For subfloor up to ¾" thick, 6 gauge by 1 ½" long screws may be used at the same spacing as the nails. For subfloor up to 1 ¼" thick, 10 gauge by 2 ½" long screws may be used at the same spacing as the nails.
-

Maximum Spacing of Gypsum Wallboard Fasteners			
Thickness of gypsum board (inches)	Type of framing surface	Maximum spacing of fasteners (inches)	
		Nails	Screws
1/2"	Ceiling	7"	12"
1/2"	Wall	8"	12"
5/8"	Ceiling	7"	12"
5/8"	Wall	8"	12"

**Table B-2 Maximum Spacing of Gypsum Wallboard Fasteners**

**Notes:**

1. Nails sizes for 1/2" gypsum board shall be either No. 13 gauge x 1-3/8" long x 19/64" head nails or 0.098 inch diameter x 1 1/4" long, annular ringed 5d cooler nails.
2. Nail sizes for 5/8" gypsum board shall be either No. 13 gauge x 1-5/8" long x 19/64" head nails or 0.098 inch diameter x 1-3/8" long, annular ringed 6d cooler nails.
3. Screws shall be No. 6 gauge with tapered head and 1 1/4" long for 1/2" gypsum board and 1 1/2" long 5/8" gypsum board.
4. The maximum allowable spacing of ceiling framing members for gypsum board shall be 24" centre to centre.

Minimum Allowable Nail Spacing				
Nail Size	Spacing Along the Grain	Spacing Across the Grain	Minimum Edge Distance	Minimum End Distance
6d to 12d	1 1/2"	3/4"	3/4"	1 3/4"
16d to 20d	2"	1"	1"	2 1/2"
30d to 60d	2 1/2"	1 1/4"	1 1/4"	3"

**Table B-3: Minimum Allowable Nail Spacing**

Standard Nail Sizes for Common Wire Nails			
Pennyweight designation	Nail Diameter (inches)	Gauge	Nail Length (inches)
5d	0.099"	12 1/2	1 3/4"
6d	0.113"	11 1/2	2"
8d	0.131"	10 1/4	2 1/2"
10d	0.148"	9	3"
12d	0.148"	9	3 1/4"
16d	0.162"	8	3 1/2"
20d	0.192"	6	4"
30d	0.207"	5	4 1/2"
40d	0.225"	4	5"
50d	0.244"	3	5 1/2"
60d	0.263"	2	6"

**Table B-4: Standard Nail Sizes for Common Wire Nails**

Standard Wood Screw Sizes		
Gauge	Screw Diameter (inches)	Standard Length Available
5	0.099"	3/8" to 3/4"
6	0.138"	3/8" to 1 1/2"
7	0.151"	3/8" to 1 1/2"
8	0.164"	1/2" to 2"

9	0.177"	$\frac{5}{8}$ " to 2 $\frac{1}{4}$ "
10	0.190"	$\frac{5}{8}$ " to 2 $\frac{1}{2}$ "
12	0.216"	$\frac{7}{8}$ " to 3"
14	0.242"	1" to 4 $\frac{1}{2}$ "
16	0.268"	1 $\frac{1}{4}$ " to 5 $\frac{1}{2}$ "
18	0.294"	1 $\frac{1}{2}$ " to 6"
20	0.320"	1 $\frac{3}{4}$ " to 6"
24	0.372"	3 $\frac{1}{2}$ " to 6"

**Table B-5: Standard Wood Screw Sizes**



### 36 APPENDIX C: REFERENCED DOCUMENTS

The standards and codes referenced in Tables C1 and C2 shall be considered to be part of the requirements of this code to the prescribed extent of each such reference in the main text of the code. Where differences occur between the provisions of this code and referenced standards, the provisions of this code shall apply.

<b>Table C1: Referenced Codes and Other Documents</b>		
<b>REFERENCED NUMBER</b>	<b>TITLE</b>	<b>PUBLISHER</b>
	Bermuda Commercial Building Code 1998	Government of Bermuda
	Bermuda Plan 2008	Government of Bermuda
ACI 318-95	Building Code Requirements for Structural Concrete ACI 318-95	American Concrete Institute
ACI 530-95	Building Code Requirements for Masonry Institute	American Concrete Structures ACI 530-95
ACI 530.1-95	Specification for Masonry Structures ACI 530.1-95	American Concrete Institute
ASCE 7-95	Minimum Design Loads for Buildings ASCE 7-95	American Society of Civil Engineers
NFPA 58-95	Standard for the Storage and Handling of Liquefied Petroleum Gases 1995	National Fire Protection Association
IPC 1995	International Plumbing Code 2009	International Code Council
IMC 1996	International Mechanical Code 2009	International Code Council
NEC 1996	National Electrical Code (NEC) 2008	National Fire Protection Association

<b>TABLE C2: Referenced ASTM Standards</b>	
<b>REFERENCE NUMBER</b>	<b>TITLE</b>
ASTM A-53	Specification for Pipe, Steel, Black and Hot-Dipped, Zinc-Coated, Welded and Seamless
ASTM A-74	Specification for Cast Iron Soil Pipe and Fittings
ASTM A-106	Specification for Seamless Carbon Steel Pipe for High-Temperature Service
ASTM A-153	Specification for Zinc Coating (Hot-Dip) on Iron and Steel Hardware
ASTM A-377	Specification for Ductile-Iron Pressure Pipe
ASTM A-525	Specification for General Requirements for Steel Sheet, Zinc Coated (Galvanised) by the Hot-Dip Process
ASTM A-767	Specification for Zinc Coated (Galvanised) Steel Bars for Concrete Reinforcement
ASTM A-888	Specification for Hubless Cast Iron Soil Pipe and Fittings for Sanitary and Storm Drain, Waste and Vent Piping Applications
ASTM B-42	Specification for Seamless Copper Pipe, Standard Sizes
ASTM B-43	Specification for Seamless Red Brass Pipe, Standard Sizes
ASTM B-75	Specification for Seamless Copper Tube
ASTM B-88	Specification for Seamless Copper Water Tube
ASTM B-251	Specification for General Requirements for Wrought Seamless Copper and Copper-Alloy Tube
ASTM B-280	Specification for Seamless Copper Tube for Air Conditioning and Refrigeration Field Service

ASTM B-302	Specification for Threadless Copper Pipe
ASTM B-306	Specification for Copper Drainage Tube (DWV)
ASTM C-4	Specification for Clay Drain Tube
ASTM C-90	Specification for Loadbearing Concrete Masonry Units
ASTM C-140	Specification for Sampling and Testing Concrete Masonry Units
ASTM C-270	Specification for Mortar for Unit Masonry
ASTM D-1785	Specification for Polyvinyl Chloride (PVC) Plastic Pipe, Schedules 40, 80 and 120
ASTM D-2241	Specification for Polyvinyl Chloride (PVC) Pressure-Rated Pipe (SDR Series)
ASTM D-2513	Specification for Thermoplastic Gas Pressure Pipe, Tubing and Fittings
ASTM D-2665	Specification for Polyvinyl Chloride (PVC) Plastic Drain, Waste and Vent Pipe and Fittings
ASTM D-2672	Specification for Joints for IPS PVC Pipe Using Solvent Cement
ASTM D-2846	Specification for Chlorinated Polyvinyl Chloride (CPVC) Plastic Hot and Cold Water Distribution Systems
ASTM D-2949	Specification for 3.25-inch Outside Diameter Polyvinyl Chloride (PVC) Plastic Drain, Waste and Vent Pipe and Fittings
ASTM E-84	Specification for Surface Burning Characteristics of Building Materials
ASTM E-90	Specification for Laboratory Measurement of Airborne Sound Transmission Loss of Building Partitions
ASTM E-108	Specification for Fire Test of Roof Coverings
ASTM E-119	Specification for Fire Tests of Building Construction and Materials
ASTM E-492	Specification for Laboratory Measurement of Impact Sound Transmission Through Floor-Ceiling Assemblies Using the Tapping Machine
ASTM F-441	Specification of Chlorinated Polyvinyl Chloride (CPVC) Plastic Pipe, Schedules 40 and 80
ASTM F-442	Specification for Chloride Polyvinyl Chloride (CPVC) Plastic Pipe (SDR-PR)
ASTM F-891	Specification for Coextruded Polyvinyl Chloride (CPVC) Plastic Pipe with a Cellular Core

Note that the contents of the following documents are not requirements of this code and are listed for reference purposes only.

<b>TABLE C3: Referenced Documents used in the Production of the Bermuda Residential Building Code</b>		
IBC 2012	International Building Code 2012	Building Officials and Code Administrators Inc
IRC 2012	International Residential Building Code 2012	The Council of American Building Officials

**37 APPENDIX D: PART 2 ACCESSIBILITY – ADVISORY GUIDANCE FOR SINGLE DWELLINGS**

**37.1 THE STRUCTURE OF PART TWO**

The structure of the Accessibility Guideline is divided into 6 Chapters aligning with both the ADA 2010 Standards for Accessible Design (the ADA Standards) and the American National Standard: *ICC A117.1-2009*. Please read these standards in conjunction with with the Accessibility Guideline.

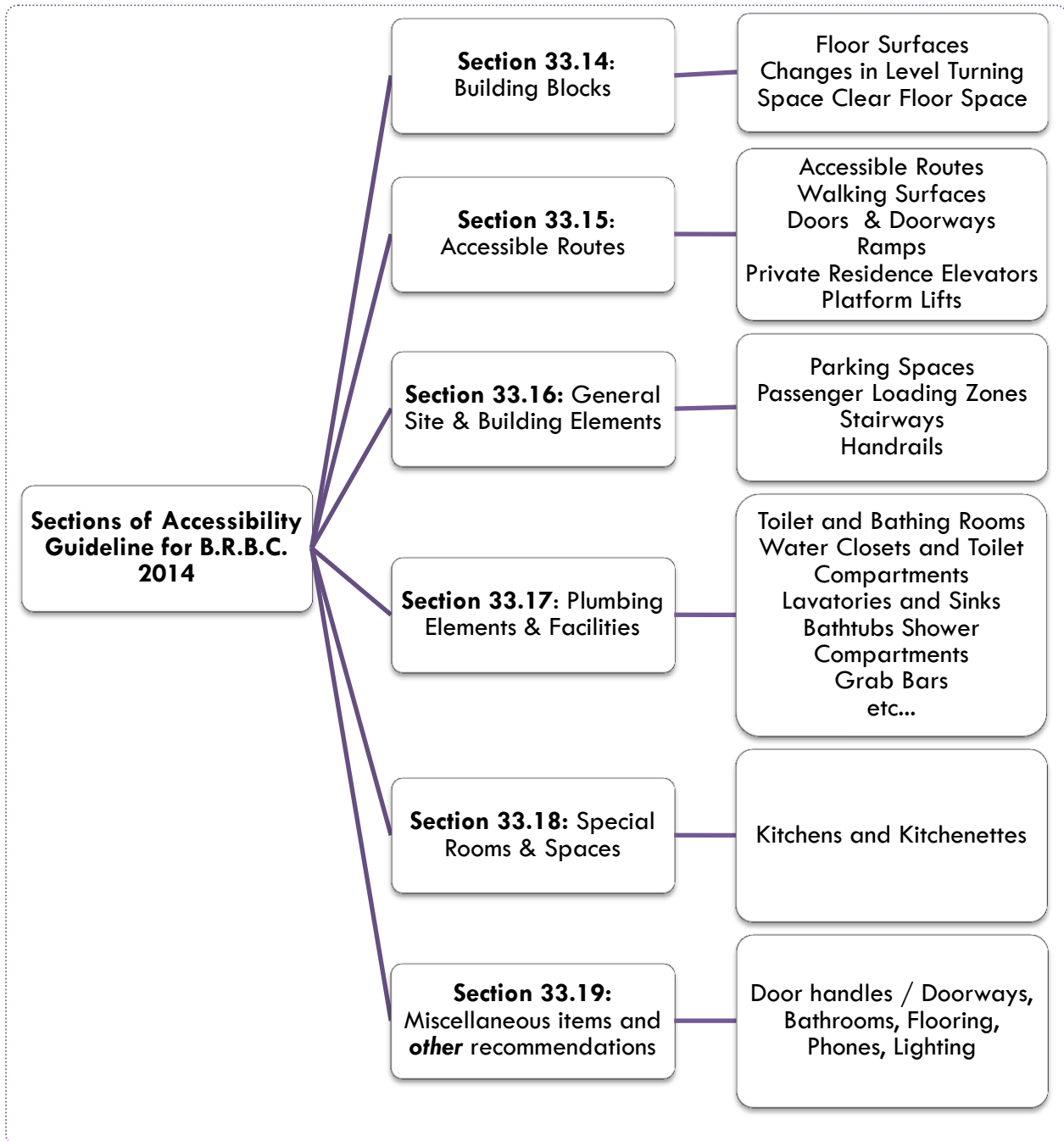

**37.2 BUILDING BLOCKS****37.2.1 FLOOR OR GROUND SURFACES****37.2.1.1 GENERAL**

Floor and ground surfaces shall be stable, firm, and slip resistant.

**EXCEPTIONS:**

1. Within animal containment areas, floor and ground surfaces shall not be required to be stable, firm, and slip resistant.
2. *Areas of sport activity* shall not be required to be stable, firm, and slip resistant.

**Advisory General.** A stable surface is one that remains unchanged by contaminants or applied force, so that when the contaminant or force is removed, the surface returns to its original condition. A firm surface resists deformation by either indentations or particles moving on its surface. A slip-resistant surface provides sufficient frictional counterforce to the forces exerted in walking to permit safe ambulation.

3.

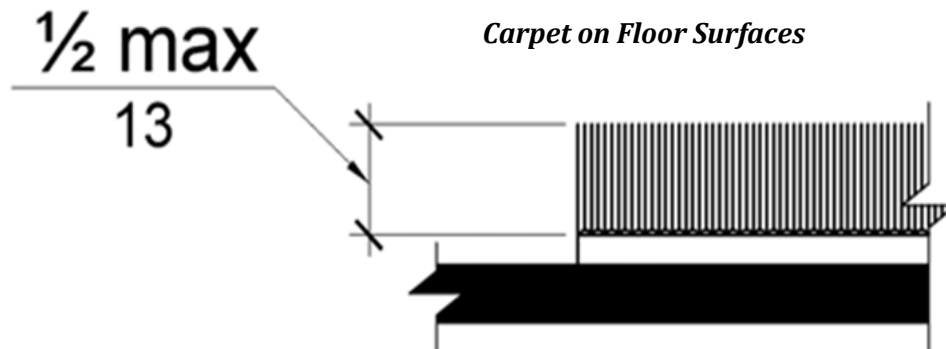

**Carpet.** Carpet or carpet tile shall be securely attached and shall have a firm cushion, pad, or backing or no cushion or pad. Carpet or carpet tile shall have a level loop, textured loop, level cut pile, or level cut/uncut pile texture. Pile height shall be 1/2 inch (13 mm) maximum. Exposed edges of carpet shall be fastened to floor surfaces and shall have trim on the entire length of the exposed edge. Carpet edge trim shall comply with 303.

**Advisory Carpet.** Carpets and permanently affixed mats can significantly increase the amount of force (roll resistance) needed to propel a wheelchair over a surface. The firmer the carpeting and backing, the lower the roll resistance. A pile thickness up to 1/2 inch (13 mm) (measured to the backing, cushion, or pad) is allowed, although a lower pile provides easier wheelchair maneuvering. If a backing, cushion or pad is used, it must be firm. Preferably, carpet pad should not be used because the soft padding increases roll resistance

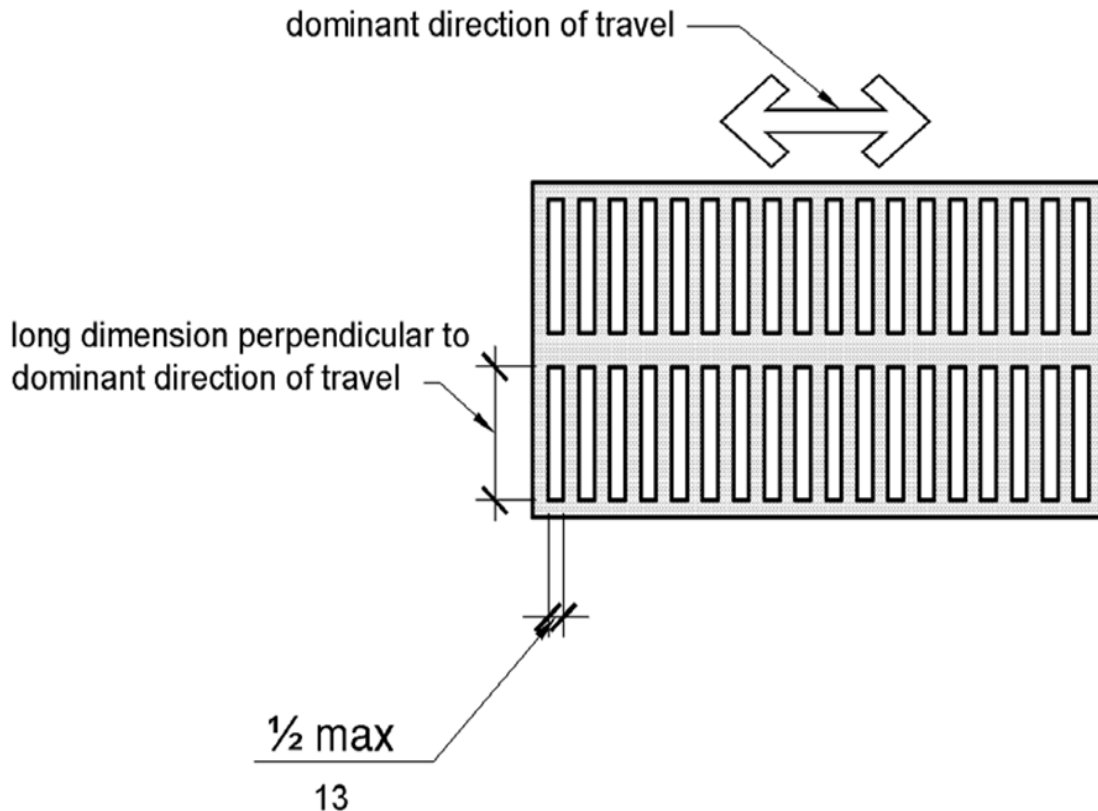

**Openings.** Openings in floor or ground surfaces shall not allow passage of a sphere more than  $\frac{1}{2}$  inch (13 mm) diameter except as allowed in 407.4.3, 409.4.3, 410.4, 810.5.3 and 810.10. Elongated openings shall be placed so that the long dimension is perpendicular to the dominant direction of travel.

*Elongated Openings in Floor or Ground Surfaces*

**37.2.2 CHANGES IN LEVEL**

**37.2.2.1 GENERAL**

Where changes in level are permitted in floor or ground surfaces, they shall comply with the following diagram.

**EXCEPTIONS:**

1. Animal containment areas shall not be required to comply with 37.3.2.1.
2. Areas of sport activity shall not be required to comply with 37.3.2.1.

**Vertical Changes**

**37.2.2.1.1 Vertical.** Changes in level of ¼ inch (6.4 mm) high maximum shall be permitted to be vertical.



**Beveled Options**

**37.2.2.1.2 Beveled.** Changes in level between ¼ inch (6.4 mm) high minimum and ½ inch (13 mm) high maximum shall be beveled with a slope not steeper than 1:2.

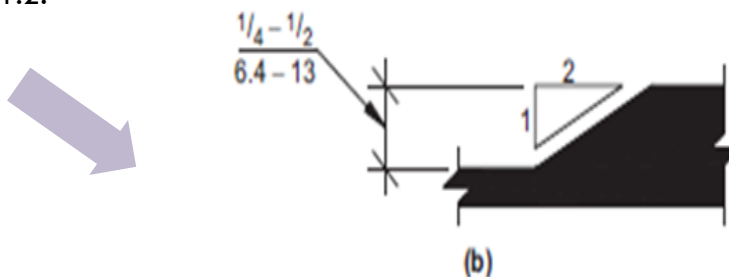
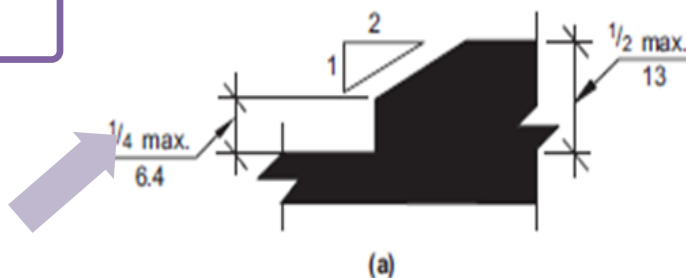

Figure 37-1: Vertical and Beveled Changes in Level

**Advisory Beveled.** A change in level of ½ inch (13 mm) is permitted to be ¼ inch (6.4 mm) vertical plus ¼ inch (6.4 mm) beveled. However, in no case may the combined change in level exceed ½ inch (13 mm). Changes in level exceeding ½ inch (13 mm) must comply with 33.15.4-33.15.6 (Ramps) or 406 (Curb Ramps) of the ADA Standards.

**37.2.2.2 RAMPS**

Changes in level greater than ½ inch (13 mm) high shall be *ramped*, and shall comply with Section 406 of the ADA Standards.

**37.2.3 TURNING SPACE**

**37.2.3.1 GENERAL**

Turning space shall comply with 33.14.3.1-33.14.3.4.

**37.2.3.2 FLOOR OR GROUND SURFACES**

Floor or ground surfaces of a turning space shall comply with 33.14.1. Changes in level are not permitted.

**Advisory 33.14.3.2 Floor or Ground Surface Exception.** *As used in this section, the phrase “changes in level” refers to surfaces with slopes and to surfaces with abrupt rise exceeding that permitted in Section 33.14.2.3. Such changes in level are prohibited in required clear floor and ground spaces, turning spaces, and in similar spaces where people using wheelchairs and other mobility devices must park their mobility aids such as in wheelchair spaces, or maneuver to use elements such as at doors, fixtures, and telephones. The exception permits slopes not steeper than 1:48.*

**EXCEPTION:** Slopes not steeper than 1:48 shall be permitted.

**37.2.3.3 SIZE**

Turning spaces shall comply with as follows:

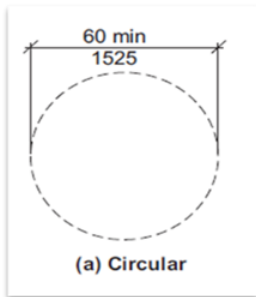

**Circular Space.** The turning space shall be a space of 60 inches (1525 mm) diameter minimum. The space shall be permitted to include knee and toe clearance complying with 306 of the ADA Standards.

**T-Shaped Space.** The turning space shall be a T-shaped space within a 60 inch (1525 mm) square minimum with arms and base 36 inches (915 mm) wide minimum. Each arm of the T shall be clear of obstructions 12 inches (305 mm) minimum in each direction and the base shall be clear of obstruction 24 inches (610 mm) minimum. The space shall be permitted to include knee and toe clearance complying with 306 of the ADA Standards only at the end of either the base or one arm.

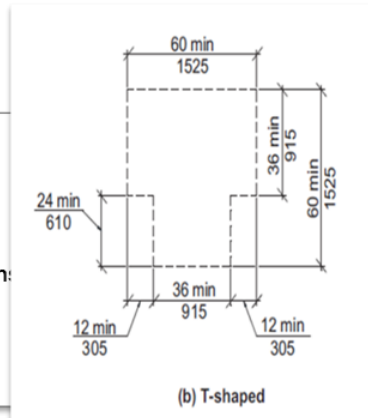

**37.2.3.4 DOOR SWING**

Doors shall be permitted to swing into turning spaces.

### 37.2.3.5 GENERAL

Clear floor or ground *space* shall comply with 305.

### 37.2.3.6 FLOOR OR GROUND SURFACE

Floor or ground surfaces of a clear floor or ground *space* shall comply with 33.14.1. Changes in level are not permitted.

**EXCEPTION:** Slopes not steeper than 1:48 shall be permitted.

### 37.2.3.7 SIZE

The clear floor or ground *space* shall be 30 inches (760 mm) minimum by 48 inches (1220 mm) minimum.

## 37.2.4 CLEAR FLOOR SPACE OR GROUND SPACE

### 37.2.4.1 GENERAL

A clear floor space shall comply with Section 33.14.3.5-33.14.4.3.

### 37.2.4.2 FLOOR SURFACES

Floor surfaces of a clear floor space shall comply with Section 33.14.1. Changes in level are not permitted within the clear floor space.

**EXCEPTION:** Slopes not steeper than 1:48 shall be permitted.

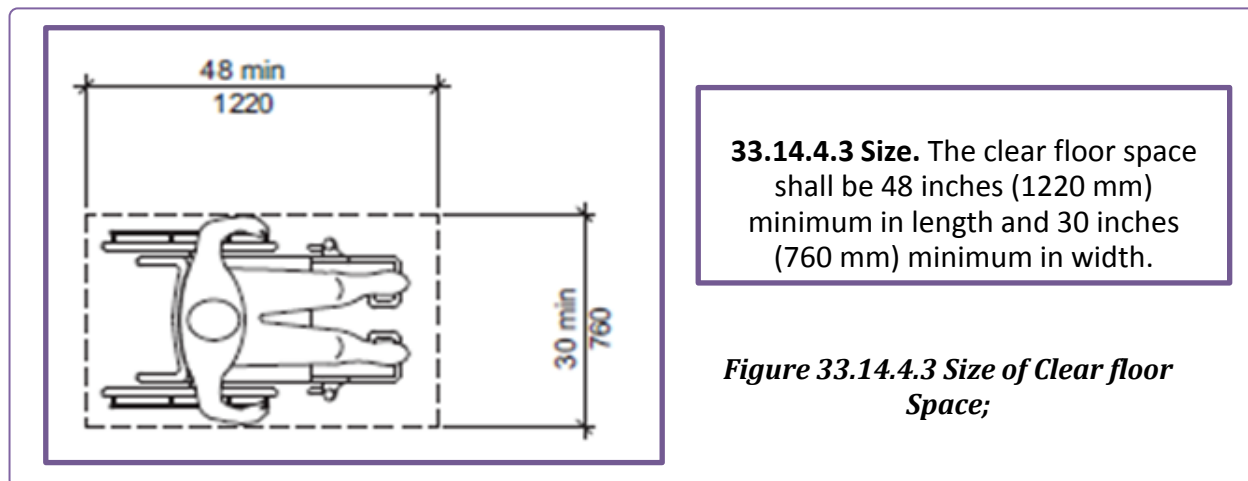

## 37.3 ACCESSIBLE ROUTES

### 37.3.1 GENERAL

Accessible routes shall comply with 33.15.

#### 37.3.1.1 COMPONENTS

*Accessible* routes shall consist of one or more of the following components: walking surfaces with a *running slope* not steeper than 1:20, doorways, *ramps*, *curb ramps* excluding the flared sides, elevators, and platform lifts. All components of an *accessible* route shall comply with the applicable requirements of Chapter 4.



**Advisory 33.15.1.1 Components.** Walking surfaces must have running slopes not steeper than 1:20, see 33.15.2.3. Other components of accessible routes, such as ramps (33.15.4-33.15.6) and curb ramps (406 of the ADA Standards), are permitted to be more steeply sloped.

### 37.3.2 WALKING SURFACES

#### 37.3.2.1 GENERAL

Walking surfaces that are a part of an *accessible* route shall comply with 33.15.2.

#### 37.3.2.2 FLOOR OR GROUND SURFACE.

Floor or ground surfaces shall comply with 33.14.1.

#### 37.3.2.3 SLOPE

The *running slope* of walking surfaces shall not be steeper than 1:20. The *cross slope* of walking surfaces shall not be steeper than 1:48.

#### 37.3.2.4 CHANGES IN LEVEL

Changes in level shall comply with 33.14.2.

#### 37.3.2.5 CLEARANCES

Walking surfaces shall provide clearances complying with 33.15.2.5.

**EXCEPTION:** Within *employee work areas*, clearances on *common use circulation paths* shall be permitted to be decreased by *work area equipment* provided that the decrease is essential to the function of the work being performed.

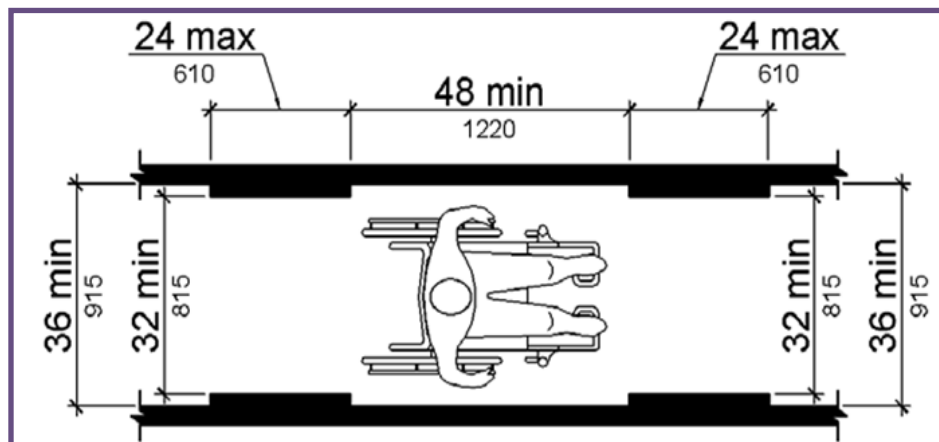

**Figure 33.15.2.5.1 Clear Width of an Accessible Route**

#### 37.3.2.5.1 CLEAR WIDTHS.

Except as provided below, the clear width of walking surfaces shall be 36 inches (915 mm) minimum.

- **EXCEPTION:** The clear width shall be permitted to be reduced to 32 inches (815 mm) minimum for a length of 24 inches (610 mm) maximum provided that reduced width

segments are separated by segments that are 48 inches (1220 mm) long minimum and 36 inches (915 mm) wide minimum.

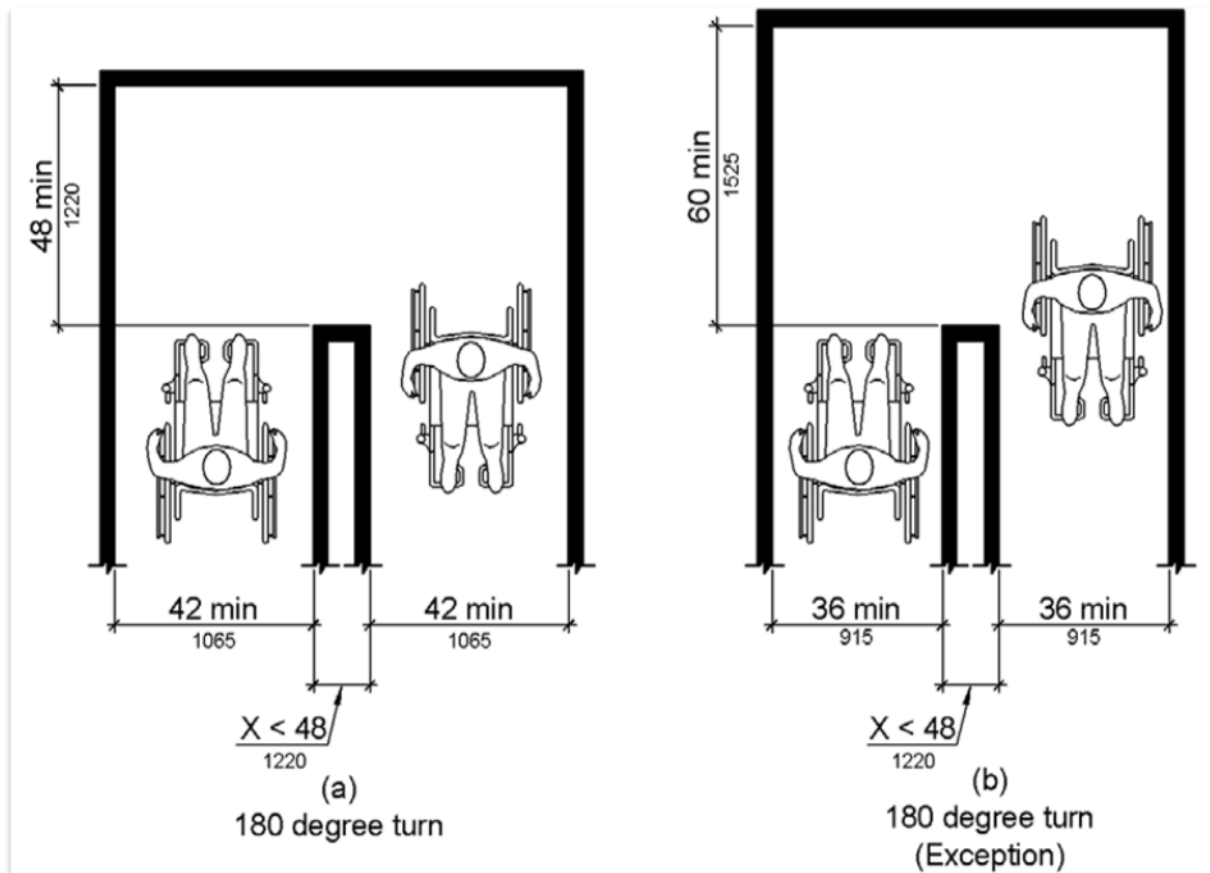

**Figure 33.15.2.5.2 Clear Width at Turn**

#### 37.3.2.5.2 CLEAR WIDTHS AT TURN.

Where the accessible route makes a 180 degree turn around an element which is less than 48 inches (1220 mm) wide, clear width shall be 42 inches (1065 mm) minimum approaching the turn, 48 inches (1220 mm) minimum at the turn and 42 inches (1065 mm) minimum leaving the turn.

**EXCEPTION:** Where the clear width at the turn is 60 inches (1525 mm) minimum compliance shall not be required.

#### 37.3.2.5.3 PASSING SPACES.

An accessible route with a clear width less than 60 inches (1525 mm) shall provide passing spaces at intervals of 200 feet (61 m) maximum. Passing spaces shall be either: a space 60 inches (1525 mm) minimum by 60 inches (1525 mm) minimum; or, an intersection of two walking surfaces providing a T-shaped space complying with 33.14.3.3.2 where the base and arms of the T-shaped space extend 48 inches (1220 mm) minimum beyond the intersection.

#### 37.3.2.6 HANDRAILS

Where handrails are provided along walking surfaces with running slopes not steeper than 1:20 they shall comply with 33.16.3.

**Advisory 33.15.2.6 Handrails.** Handrails provided in elevator cabs and platform lifts are not required to comply with the requirements for handrails on walking surfaces.

### 37.3.3 DOORS, DOORWAYS & GATES

#### 37.3.3.1 GENERAL

Doors, doorways, and gates that are part of an *accessible* route shall comply with 33.15.3.

**EXCEPTION:** Doors, doorways, and gates designed to be operated only by security personnel shall not be required to comply with Sections 404.2.7, 404.2.8, 404.2.9, 404.3.2 and 404.3.4 through 404.3.7 of the ADA Standards.

#### 37.3.3.2 MANUAL DOORS, DOORWAYS, AND MANUAL GATES.

Manual doors and doorways and manual gates intended for user passage shall comply with 33.15.3.2.

**Advisory 33.15.3.1 General Exception.** Security personnel must have sole control of doors that are eligible for the Exception at 33.15.3.1. It would not be acceptable for security personnel to operate the doors for people with disabilities while allowing others to have independent access.

##### 37.3.3.2.1 Revolving Doors, Gates, and Turnstiles

Revolving doors, revolving gates, and turnstiles shall not be part of an *accessible* route.

##### 37.3.3.2.2 Double-Leaf Doors and Gates.

At least one of the active leaves of doorways with two leaves shall comply with 33.15.3.2.3.

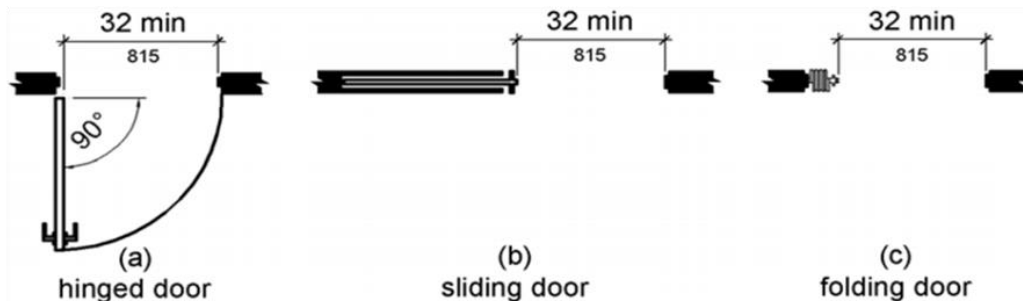

**33.15.3.2.3 Clear Width.** Door openings shall provide a clear width of 32 inches (815 mm) minimum. Clear openings of doorways with swinging doors shall be measured between the face of the door and the stop, with the door open 90 degrees. Openings more than 24 inches (610 mm) deep shall provide a clear opening of 36 inches (915 mm) minimum. There shall be no projections into the required clear opening width lower than 34 inches (865 mm) above the finish floor or ground. Projections into the clear opening width between 34 inches (865 mm) and 80 inches (2030 mm) above the finish floor or ground shall not exceed 4 inches (100 mm).

**EXCEPTIONS:**

1. In *alterations*, a projection of 5/8 inch (16 mm) maximum into the required clear width shall be permitted for the latch side stop.
2. Door closers and door stops shall be permitted to be 78 inches (1980 mm) minimum above the finish floor or ground.

***For more on Maneuvering Clearances, Swinging Doors and Gates, Maneuvering Clearances at Manual Swinging Doors and Gates refer to Chapter 4 of the 2010 ADA Standards.***

### **37.3.4 RAMPS**

#### **37.3.4.1 GENERAL**

Ramps on *accessible* routes shall comply with 33.15.

***EXCEPTION:*** In *assembly areas*, aisle ramps adjacent to seating and not serving *elements* required to be on an *accessible* route shall not be required to comply with 33.15.

#### **37.3.4.2 SLOPE**

Ramp runs shall have a running slope not steeper than 1:12.

***EXCEPTION:*** In existing *sites, buildings, and facilities*, ramps shall be permitted to have *running slopes* steeper than 1:12 complying with Table 33.15.4.2 where such slopes are necessary due to *space* limitations.

**Table 33.15.4.2 Maximum Ramp Slope and Rise for Existing Sites, Buildings, and Facilities**

Slope <sup>1</sup>	Maximum Rise
Steeper than 1:10 but not steeper than 1:8	3 inches (75 mm)
Steeper than 1:12 but not steeper than 1:10	6 inches (150 mm)
<b>1. A slope steeper than 1:8 is prohibited.</b>	
<i>Advisory 33.15.4.2 Slope. To accommodate the widest range of users, provide ramps with the least possible running slope and, wherever possible, accompany ramps with stairs for use by those individuals for whom distance presents a greater barrier than steps, e.g., people with heart disease or limited stamina</i>	

#### **37.3.4.3 CLEAR WIDTH**

The clear width of a *ramp* run and, where handrails are provided, the clear width between handrails shall be 36 inches (915 mm) minimum.

***EXCEPTION:*** Within *employee work areas*, the required clear width of *ramps* that are a part of *common use circulation paths* shall be permitted to be decreased by *work area equipment* provided that the decrease is essential to the function of the work being performed.

#### **37.3.4.4 RISE**

The rise for any *ramp* run shall be 30 inches (760 mm) maximum.

**37.3.5 HOW LONG SHOULD MY RAMP BE?**

To determine your ramp length **you first need to determine the rise**. The rise is the vertical measurement between the ground and where the top of the ramp is going to sit. A **1:12 slope** (used by the ADA) would require 1 foot length of ramp for every inch of vertical rise.

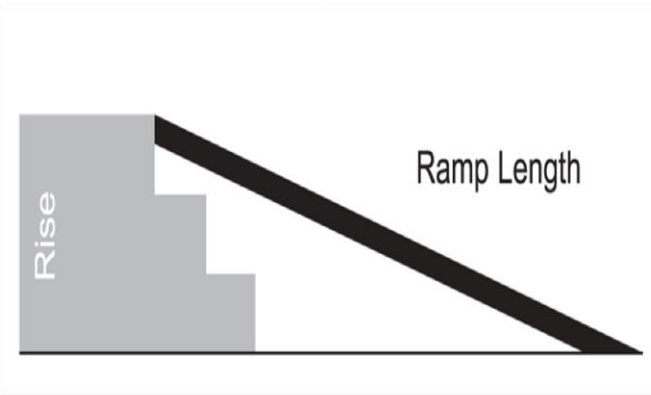

**Slope Recommendations based on Use of Ramp: 1:12 SLOPE (4.8°)** – Gradual, gentle incline, longest ramp. **Calculated as 1 foot length of ramp for every 1 inch of total vertical rise (the rise divided by 1)**. A 5 inch rise requires a 5 foot ramp and a 12 inch rise requires a 12 foot ramp and so on. The ADA recommends this slope for long home ramps as well as commercial ramps.

Examples of 1:12 Ramps

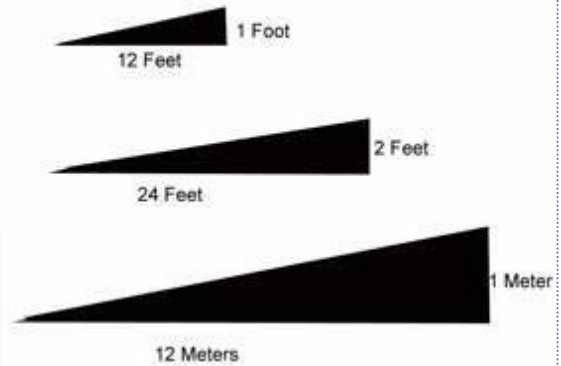

*Figure 33.15.5 Detailing the Slope Recommendations*

Source:  
<http://www.allegromedical.com/blog/access-ramps-choosing-the-right-length-wheelchair-ramp-or-disability-access-ramp-1594.html>

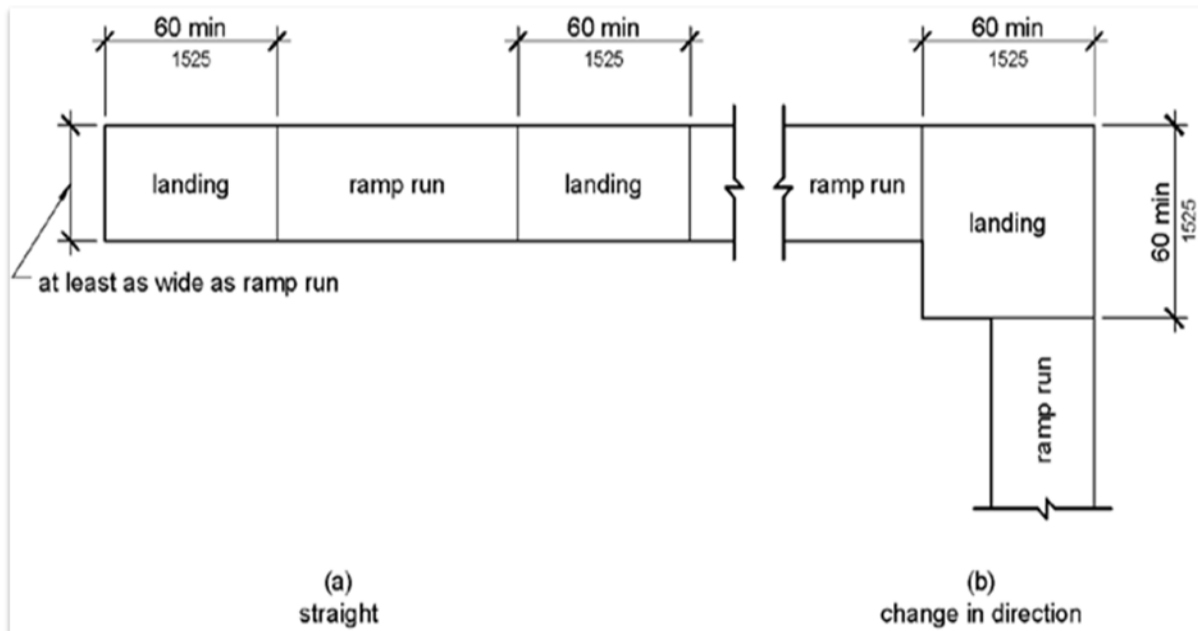
**37.3.6 LANDINGS**

**33.15.6.1 Landings.** Ramps shall have landings at the top and the bottom of each ramp run. Landings shall comply with 33.15.6.1.

**Advisory 33.15.6.1 Landings.** Ramps that do not have level landings at changes in direction can create a compound slope that will not meet the requirements of this document. Circular or curved ramps continually change direction. Curvilinear ramps with small radii also can create compound cross slopes and cannot, by their nature, meet the requirements for accessible routes. A level landing is needed at the accessible door to permit maneuvering and simultaneously door operation.

Slope.

Landings shall comply with 33.14.1. Changes in level are not permitted.

**EXCEPTION:** Slopes not steeper than 1:48 shall be permitted.

**37.3.6.1.1 Width**

The landing clear width shall be at least as wide as the widest *ramp run* leading to the landing.

**37.3.6.1.2 Length**

The landing clear length shall be 60 inches (1525 mm) long minimum.

**37.3.6.1.3 Change in Direction**

Ramps that change direction between runs at landings shall have a clear landing 60 inches (1525 mm) minimum by 60 inches (1525 mm) minimum.

**37.3.6.1.4 Doorways**

Where doorways are located adjacent to a *ramp* landing, maneuvering clearances required by 404.2.4 and 404.3.2 (of the ADA Standards) shall be permitted to overlap the required landing area.

**37.3.6.2 HANDRAILS**

*Ramp* runs with a rise greater than 6 inches (150 mm) shall have handrails complying with 33.16.3.

***EXCEPTION:*** Within *employee work areas*, handrails shall not be required where *ramps* that are part of *common use circulation paths* are designed to permit the installation of handrails complying with 33.16.3. *Ramps* not subject to the exception to 33.15.4.3 shall be designed to maintain a 36 inch (915 mm) minimum clear width when handrails are installed.

**37.3.7 PRIVATE RESIDENCE ELEVATORS****37.3.7.1 GENERAL**

Private residence elevators that are provided within a *residential dwelling unit* required to provide mobility features complying with 809.2 through 809.4 of the ADA Standards shall comply with 33.15.7 and with ASME A17.1 (incorporated by reference, see “Referenced Standards” in Chapter 1). They shall be passenger elevators as classified by ASME A17.1. Elevator operation shall be automatic.

**37.3.7.2 CALL BUTTONS**

Call buttons shall be  $\frac{3}{4}$  inch (19 mm) minimum in the smallest dimension and shall comply with 309 of the ADA Standards.

**37.3.7.3 ELEVATOR DOORS**

Hoistway doors, car doors, and car gates shall comply with 33.15.7.3 and 33.15.3.

***EXCEPTION:*** Doors shall not be required to comply with the maneuvering clearance requirements in 33.15.3.2.1 for approaches to the push side of swinging doors.

**37.3.7.3.1 Power Operation**

Elevator car and hoistway doors and gates shall be power operated and shall comply with ANSI/BHMA A156.19 (1997 or 2002 edition) (incorporated by reference, see “Referenced Standards” in Chapter 1). Power operated doors and gates shall remain open for 20 seconds minimum when activated.

***EXCEPTION:*** In elevator cars with more than one opening, hoistway doors and gates shall be permitted to be of the manual-open, self-close type.

**37.3.7.3.2 Location**

Elevator car doors or gates shall be positioned at the narrow end of the clear floor *spaces* required by 33.15.7.4.1.

**37.3.7.4 ELEVATOR CARS**

Private residence elevator cars shall comply with 33.15.7.4.

**37.3.7.4.1 Inside Dimensions of Elevator Cars**

Elevator cars shall provide a clear floor space of 36 inches (915 mm) minimum by 48 inches (1220 mm) minimum and shall comply with 33.14.3.5-33.14.4.3.

**37.3.7.4.2 Floor Surfaces**

Floor surfaces in elevator cars shall comply with 33.14.1 and 33.14.2.

**37.3.7.4.3 Platform to Hoistway Clearance**

The clearance between the car platform and the edge of any landing sill shall be 1½ inch (38 mm) maximum.

**37.3.7.4.4 Leveling**

Each car shall automatically stop at a floor landing within a tolerance of ½ inch (13 mm) under rated loading to zero loading conditions.

**37.3.7.4.5 Illumination Levels**

Elevator car illumination shall comply with 407.4.5 of the ADA Standards.

**37.3.7.4.6 Car Controls**

Elevator car control buttons shall comply with 33.15.7.4.6, and 309.3 and 309.4 of the ADA Standards, and shall be raised or flush.

**37.3.7.4.6.1 Size**

Control buttons shall be ¾ inch (19 mm) minimum in their smallest dimension.

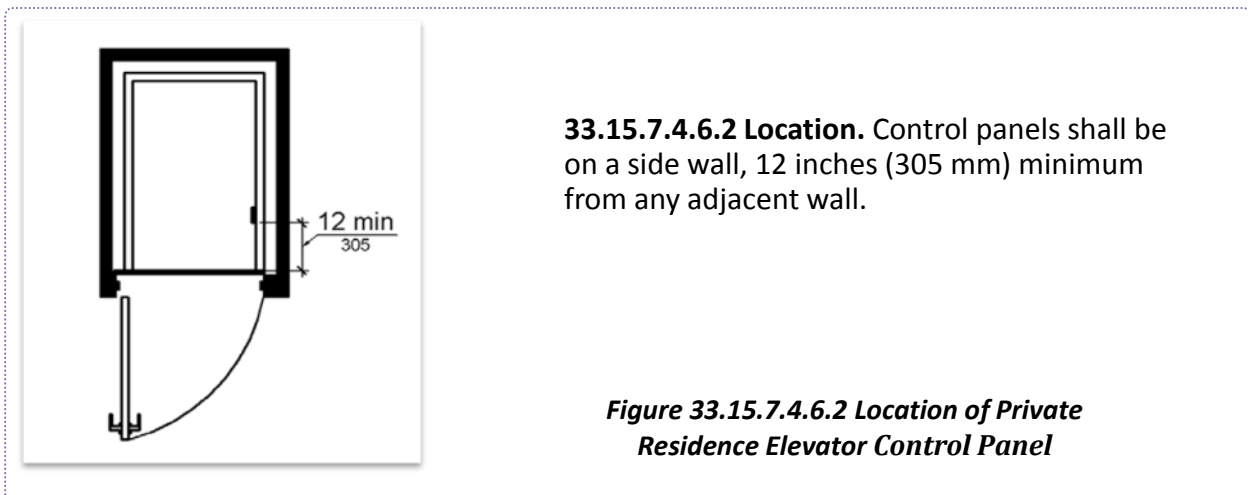

**33.15.7.4.6.2 Location.** Control panels shall be on a side wall, 12 inches (305 mm) minimum from any adjacent wall.

**Figure 33.15.7.4.6.2 Location of Private Residence Elevator Control Panel**

**37.3.7.4.7 Emergency Communications.** Emergency two-way communication systems shall comply with 33.15.7.4.7.

**37.3.7.4.7.1 Type**

A telephone and emergency signal device shall be provided in the car.

**37.3.7.4.7.2 Operable Parts**

The telephone and emergency signaling device shall comply with 309.3 and 309.4 of the ADA Standards.



**37.3.7.4.7.3 Compartment**

If the telephone or device is in a closed compartment, the compartment door hardware shall comply with 309 of the ADA Standards.

**37.3.7.4.7.4 Cord**

The telephone cord shall be 29 inches (735 mm) long minimum.

**37.3.8 PLATFORM LIFTS****37.3.8.1 GENERAL**

Platform lifts shall comply with ASME A18.1 (1999 edition or 2003 edition) (incorporated by reference, see “Referenced Standards” in Chapter 1). Platform lifts shall not be attendant-operated and shall provide unassisted entry and exit from the lift.

**Advisory 33.15.8.1 General.** *Inclined stairway chairlifts and inclined and vertical platform lifts are available for short-distance vertical transportation. Because an accessible route requires an 80 inch (2030 mm) vertical clearance, care should be taken in selecting lifts as they may not be equally suitable for use by people using wheelchairs and people standing. If a lift does not provide 80 inch (2030 mm) vertical clearance, it cannot be considered part of an accessible route in new construction.*

**37.3.8.2 FLOOR SURFACES**

Floor surfaces in platform lifts shall comply with 33.14.1 and 33.14.2.1-33.14.2.4.

**37.3.8.3 CLEAR FLOOR SPACE**

Clear floor *space* in platform lifts shall comply with 33.14.3.5-33.14.4.3.

**37.3.8.4 PLATFORM TO RUNWAY CLEARANCE**

The clearance between the platform sill and the edge of any runway landing shall be 1¼ inch (32 mm) maximum.

**37.3.8.5 OPERABLE PARTS**

Controls for platform lifts shall comply with 309 of the ADA Standards.

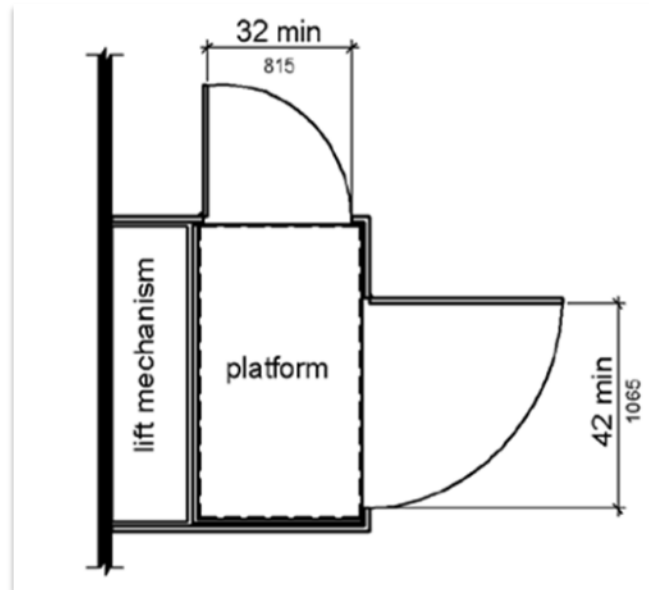

**33.15.8.6 Doors and Gates.** Platform lifts shall have low-energy power-operated doors or gates complying with 404.3 of the ADA Standards. Doors shall remain open for 20 seconds minimum. End doors and gates shall provide a clear width 32 inches (815 mm) minimum. Side doors and gates shall provide a clear width 42 inches (1065 mm) minimum.

***EXCEPTION:*** Platform lifts serving two landings maximum and having doors or gates on opposite sides shall be permitted to have self-closing manual doors or gates.

*Figure 33.15.8.6 Platform Lift Doors and Gates*

#### **37.4 GENERAL SITE & BUILDING ELEMENTS**

The provisions of 33.16 shall apply where required by Chapter 2 of the ADA Standards or where referenced by a requirement in this document.

##### **37.4.1 PARKING SPACES**

###### **37.4.1.1 GENERAL**

Car and van parking *spaces* shall comply with 33.16.1. Where parking *spaces* are marked with lines, width measurements of parking *spaces* and access aisles shall be made from the centerline of the markings.

***EXCEPTION:*** Where parking *spaces* or access aisles are not adjacent to another parking *space* or access aisle, measurements shall be permitted to include the full width of the line defining the parking *space* or access aisle.

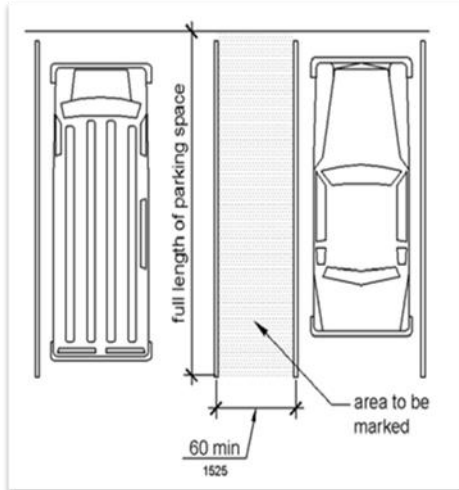

**33.16.1.2 Access Aisle.** Access aisles serving parking spaces shall comply with 33.16.1.2. Access aisles shall adjoin an *accessible* route. Two parking spaces shall be permitted to share a common access aisle.

**Figure 33.16.1.2 Parking Space Access Aisle**

### 37.4.1.2 ACCESS AISLE

#### 37.4.1.2.1 Width

Access aisles serving car and van parking spaces shall be 60 inches (1525 mm) wide minimum.

**Advisory 33.16.1.2.1 Access Aisle.** Accessible routes must connect parking spaces to accessible entrances. In parking facilities where the accessible route must cross vehicular traffic lanes, marked crossings enhance pedestrian safety, particularly for people using wheelchairs and other mobility aids. Where possible, it is preferable that the accessible route not pass behind parked vehicles.

#### 37.4.1.2.2 Length

Access aisles shall extend the full length of the parking spaces they serve.

#### 37.4.1.2.3 Marking

Access aisles shall be marked so as to discourage parking in them.

**Advisory 33.16.1.2.3 Marking.** The method and color of marking are not specified by these requirements but may be addressed by State or local laws or regulations. Because these requirements permit the van access aisle to be as wide as a parking space, it is important that the aisle be clearly marked.

#### 37.4.1.2.4 Location

Access aisles shall not overlap the *vehicular way*. Access aisles shall be permitted to be placed on either side of the parking space except for angled van parking spaces which shall have access aisles located on the passenger side of the parking spaces.

**Advisory 33.16.1.2.4 Location.** *Wheelchair lifts typically are installed on the passenger side of vans. Many drivers, especially those who operate vans, find it more difficult to back into parking spaces than to back out into comparatively unrestricted vehicular lanes. For this reason, where a van and car share an access aisle, consider locating the van space so that the access aisle is on the passenger side of the van space.*

### 37.4.1.3 FLOOR OR GROUND SURFACES

Parking spaces and access aisles serving them shall comply with 33.14.1. Access aisles shall be at the same level as the parking spaces they serve. Changes in level are not permitted.

**EXCEPTION:** Slopes not steeper than 1:48 shall be permitted.

**Advisory 33.16.1.3 Floor or Ground Surfaces.** *Access aisles are required to be nearly level in all directions to provide a surface for wheelchair transfer to and from vehicles. The exception allows sufficient slope for drainage. Built-up curb ramps are not permitted to project into access aisles and parking spaces because they would create slopes greater than 1:48.*

### 37.4.1.4 IDENTIFICATION

Parking space identification signs shall include the International Symbol of Accessibility complying with 703.7.2.1 of the ADA Standards. Signs identifying van parking spaces shall contain the designation "van accessible." Signs shall be 60 inches (1525 mm) minimum above the finish floor or ground surface measured to the bottom of the sign.

**Advisory 33.16.1.4 Identification.** *The required "van accessible" designation is intended to be informative, not restrictive, in identifying those spaces that are better suited for van use. Enforcement of motor vehicle laws, including parking privileges, is a local matter.*

### 37.4.1.5 RELATIONSHIP TO ACCESSIBLE ROUTES

Parking spaces and access aisles shall be designed so that cars and vans, when parked, cannot obstruct the required clear width of adjacent accessible routes.

**Advisory 33.16.1.5 Relationship to Accessible Routes.** *Wheel stops are an effective way to prevent vehicle overhangs from reducing the clear width of accessible routes.*

## 37.4.2 STAIRWAYS

### 37.4.2.1 GENERAL

Stairs shall comply with 33.16.2.

### 37.4.2.2 TREADS AND RISERS

All steps on a flight of stairs shall have uniform riser heights and uniform tread depths. Risers shall be 4 inches (100 mm) high minimum and 7 inches (180 mm) high maximum.

Treads shall be 11 inches (280 mm) deep minimum.

#### 37.4.2.3 OPEN RISERS

Open risers are not permitted.

#### 37.4.2.4 TREAD SURFACE

Stair treads shall comply with 33.14.1. Changes in level are not permitted.

**EXCEPTION:** Treads shall be permitted to have a slope not steeper than 1:48.

**Advisory 33.16.2.4 Tread Surface.** Consider providing visual contrast on tread nosings, or at the leading edges of treads without nosings, so that stair treads are more visible for people with low vision.

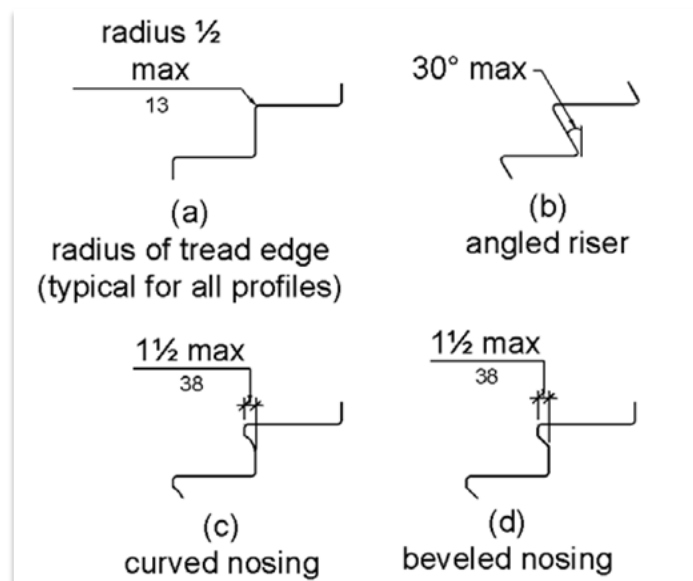

**33.16.2.5 Nosings.** The radius of curvature at the leading edge of the tread shall be 1/2 inch (13 mm) maximum. Nosings that project beyond risers shall have the underside of the leading edge curved or beveled. Risers shall be permitted to slope under the tread at an angle of 30 degrees maximum from vertical. The permitted projection of the nosing shall extend 1 1/2 inches (38 mm) maximum over the tread below.

#### 37.4.2.6 HANDRAILS

Stairs shall have handrails complying with 33.16.3.

#### 37.4.2.7 WET CONDITIONS

Stair treads and landings subject to wet conditions shall be designed to prevent the accumulation of water.

### 37.4.3 HANDRAILS

#### 37.4.3.1 GENERAL

Handrails provided along walking surfaces complying with 33.15.2, required at *ramps* complying with 33.15.4.33.15.6, and required at stairs complying with 33.16.2 shall comply with 33.16.3.

**Advisory 33.16.3.1 General.** *Handrails are required on ramp runs with a rise greater than 6 inches (150 mm) (see 33.15.62) and on certain stairways (see 33.6.2). Handrails are not required on walking surfaces with running slopes less than 1:20. However, handrails are required to comply with 33.16.3 when they are provided on walking surfaces with running slopes less than 1:20 (see 33.15.26). Sections 33.16.3.2, 33.16.3.3, and 505.1 (of the ADA Standards) do not apply to handrails provided on walking surfaces with running slopes less than 1:20 as these sections only reference requirements for ramps and stairs.*

#### 37.4.3.2 WHERE REQUIRED

Handrails shall be provided on both sides of stairs and *ramps*.

**EXCEPTION:** In *assembly areas*, handrails shall not be required on both sides of aisle *ramps* where a handrail is provided at either side or within the aisle width.

#### 37.4.3.3 CONTINUITY

Handrails shall be continuous within the full length of each stair flight or *ramp* run. Inside handrails on switchback or dogleg stairs and *ramps* shall be continuous between flights or runs.

**EXCEPTION:** In *assembly areas*, handrails on *ramps* shall not be required to be continuous in aisles serving seating.

**Advisory 33.16.3.4 Height.** *The requirements for stair and ramp handrails in this document are for adults. When children are the principal users in a building or facility (e.g., elementary schools), a second set of handrails at an appropriate height can assist them and aid in preventing accidents. A maximum height of 28 inches (710 mm) measured to the top of the gripping surface from the ramp surface or stair nosing is recommended for handrails designed for children. Sufficient vertical clearance between upper and lower handrails, 9 inches (230 mm) minimum, should be provided to help prevent entrapment.*

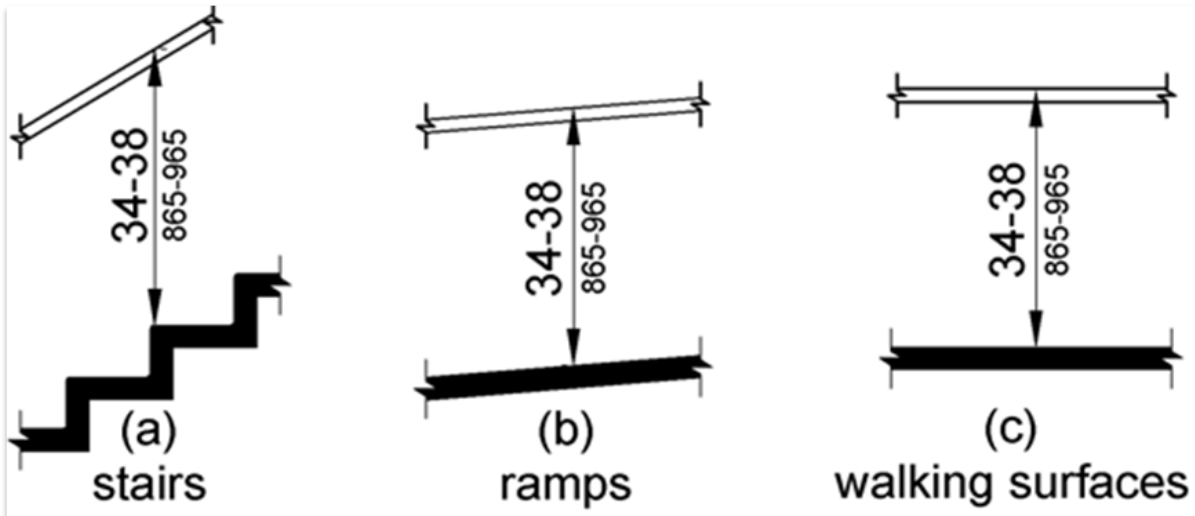

**33.16.3.4 Height.** Top of gripping surfaces of handrails shall be 34 inches (865 mm) minimum and 38 inches (965 mm) maximum vertically above walking surfaces, stair nosings, and *ramp* surfaces. Handrails shall be at a consistent height above walking surfaces, stair nosings, and *ramp* surfaces.

*Figure 33.16.3.4 Handrail Height*



**33.16.3.5 Clearance.** Clearance between handrail gripping surfaces and adjacent surfaces shall be 1½ inches (38 mm) minimum

*Figure 33.16.3.5 Handrail Clearance*

**33.16.3.6 Gripping Surface.** Handrail gripping surfaces shall be continuous along their length and shall not be obstructed along their tops or sides. The bottoms of handrail gripping surfaces shall not be obstructed for more than 20 percent of their length. Where provided, horizontal projections shall occur 1½ inches (38 mm) minimum below the bottom of the handrail gripping surface.

*Figure 33.16.3.6 Horizontal Projections Below Gripping Surface*

**Gripping Surface – EXCEPTIONS:**

1. Where handrails are provided along walking surfaces with slopes not steeper than 1:20, the bottoms of handrail gripping surfaces shall be permitted to be obstructed along their entire length where they are integral to crash rails or bumper guards.
2. The distance between horizontal projections and the bottom of the gripping surface shall be permitted to be reduced by 1/8 inch (3.2 mm) for each 1/2 inch (13 mm) of additional handrail perimeter dimension that exceeds 4 inches (100 mm).

**Advisory 33.16.3.6 Gripping Surface.** People with disabilities, older people, and others benefit from continuous gripping surfaces that permit users to reach the fingers outward or downward to grasp the handrail, particularly as the user senses a loss of equilibrium or begins to fall.

**37.4.3.7 CROSS SECTION**

Handrail gripping surfaces shall have a cross section complying with 33.16.3.7.1 or 33.16.3.7.2.

**37.4.3.7.1 Circular Cross Section**

Handrail gripping surfaces with a circular cross section shall have an outside diameter of 1 1/4 inches (32 mm) minimum and 2 inches (51 mm) maximum.

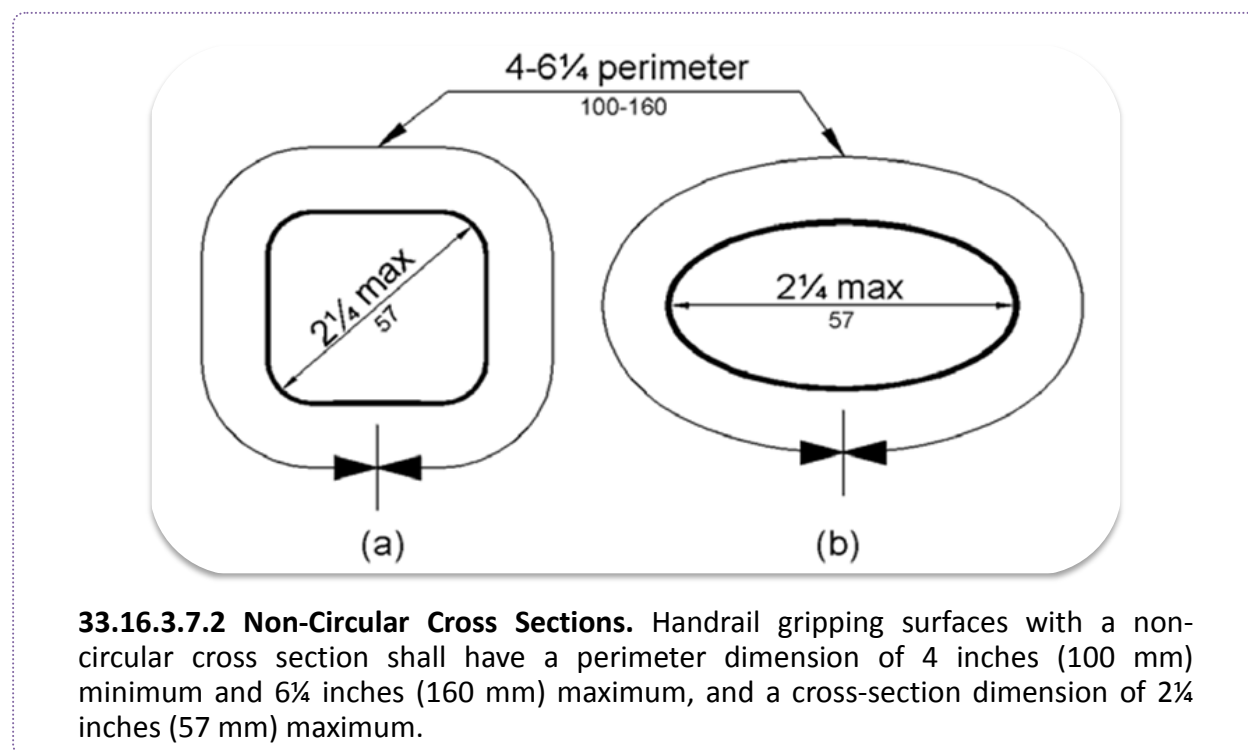

**33.16.3.7.2 Non-Circular Cross Sections.** Handrail gripping surfaces with a non-circular cross section shall have a perimeter dimension of 4 inches (100 mm) minimum and 6 1/4 inches (160 mm) maximum, and a cross-section dimension of 2 1/4 inches (57 mm) maximum.

**Figure 33.16.3.7.2 Handrail Non-Circular Cross Section Surface**

**37.4.3.8 SURFACES**

Handrail gripping surfaces and any surfaces adjacent to them shall be free of sharp or abrasive elements and shall have rounded edges.

**37.4.3.9 FITTINGS**

Handrails shall not rotate within their fittings.



**37.5 PLUMBING ELEMENTS & FACILITIES****37.5.1 TOILET AND BATHING ROOMS****37.5.1.1 GENERAL**

Toilet and bathing rooms shall comply with 33.17.1.

**37.5.1.2 CLEARANCES**

Clearances shall comply with 33.17.1.2.

**37.5.1.2.1 Turning Space**

Turning *space* complying with 33.14.3.1-33.14.3.4 shall be provided within the room.

**37.5.1.2.2 Overlap**

Required clear floor *spaces*, clearance at fixtures, and turning *space* shall be permitted to overlap.

**37.5.1.2.3 Door Swing**

Doors shall not swing into the clear floor *space* or clearance required for any fixture. Doors shall be permitted to swing into the required turning *space*.

**EXCEPTIONS:**

1. Doors to a toilet room or bathing room for a single occupant accessed only through a private office and not for *common use* or *public use* shall be permitted to swing into the clear floor *space* or clearance provided the swing of the door can be reversed to comply with 33.17.1.2.3.
2. Where the toilet room or bathing room is for individual use and a clear floor *space* complying with 33.14.3.6 is provided within the room beyond the arc of the door swing, doors shall be permitted to swing into the clear floor *space* or clearance required for any fixture.

**Advisory 33.17.1.2.3 Door Swing Exception 1.** At the time the door is installed, and if the door swing is reversed in the future, the door must meet all the requirements specified in 33.15.3. Additionally, the door swing cannot reduce the required width of an accessible route. Also, avoid violating other building or life safety codes when the door swing is reversed.

**37.5.2 WATER CLOSETS AND TOILET COMPARTMENTS****37.5.2.1 GENERAL**

Water closets and toilet compartments shall comply with 604.2 through 604.8 of the ADA Standards.

**EXCEPTION:** Water closets and toilet compartments for *children's use* shall be permitted to comply with 604.9 of the ADA Standards.

The centerline of the water closet shall be 16 inches (405 mm) minimum to 18 inches (455 mm) maximum from the side wall or partition, except that the water closet shall be 17 inches (430 mm) minimum and 19 inches (485 mm) maximum from the side wall or partition in the ambulatory

*accessible* toilet compartment specified in 604.8.2 of the ADA Standards. Water closets shall be arranged for a left-hand or right-hand approach.

**33.17.2.2 Location.** The water closet shall be positioned with a wall or partition to the rear and to one side.

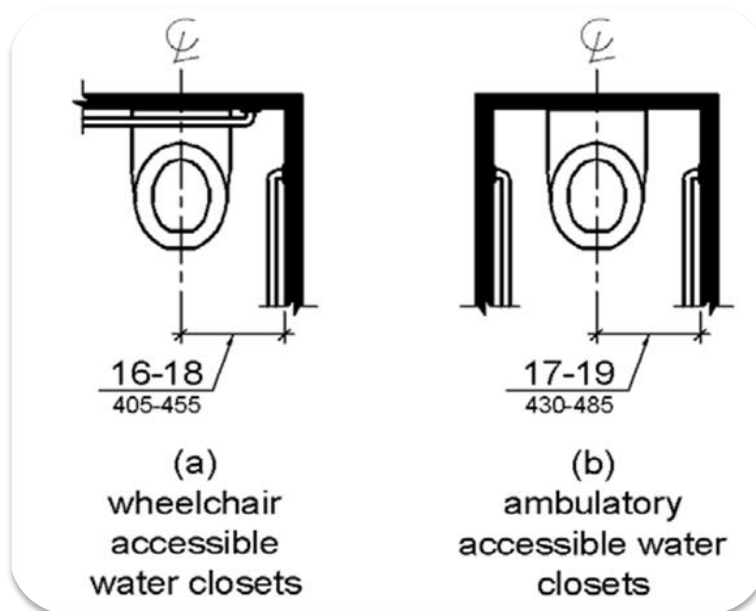

The centerline of the water closet shall be 16 inches (405 mm) minimum to 18 inches (455 mm) maximum from the side wall or partition, except that the water closet shall be 17 inches (430 mm) minimum and 19 inches (485 mm) maximum from the side wall or partition in the ambulatory *accessible* toilet compartment specified in 604.8.2 of the ADA Standards. Water closets shall be arranged for a left-hand or right-hand approach.

**Figure 33.17.2.2 Water Closet Location**

### 37.5.2.3 CLEARANCE

Clearances around water closets and in toilet compartments shall comply with 33.17.2.3. Clearance around a water closet shall be 60 inches (1525 mm) minimum measured perpendicular from the side wall and 56 inches (1420 mm) minimum measured perpendicular from the rear wall.

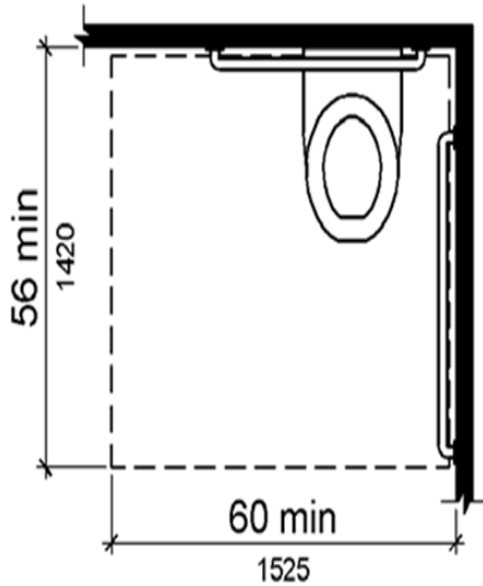

**33.17.2.3.1 Size**

- Clearance around a water closet shall be 60 inches (1525 mm) minimum measured perpendicular from the side wall and 56 inches (1420 mm) minimum measured perpendicular from the rear wall.
- Toilet and bathing fixtures required to comply with 33.17.1 through 33.17.14 shall be located in the same toilet and bathing area, such that travel between fixtures does not require travel between other parts of the *residential dwelling unit*.

*Figure 33.17.2.3.1 Size of Clearance at Water Closets*

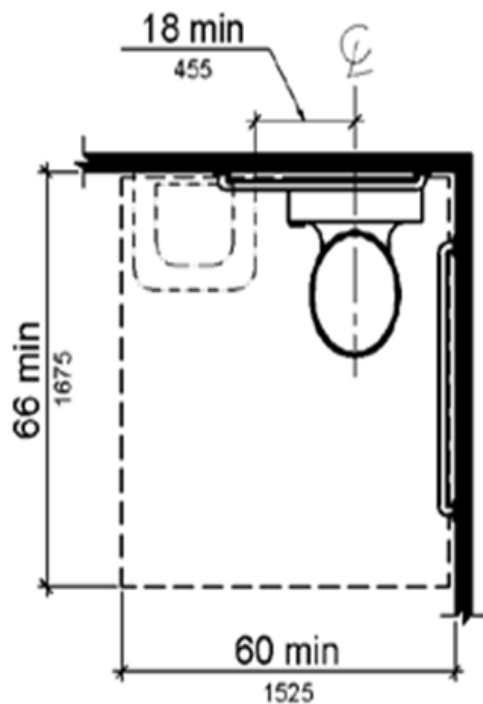

**33.17.2.3.2 Overlap**

- The required clearance around the water closet shall be permitted to overlap the water closet, associated grab bars, dispensers, sanitary napkin disposal units, coat hooks, shelves, *accessible routes*, clear floor *space* and clearances required at other fixtures, and the turning *space*. No other fixtures or obstructions shall be located within the required water closet clearance.
- EXCEPTION:** In *residential dwelling units*, a lavatory complying with 33.17.3 shall be permitted on the rear wall 18 inches (455 mm) minimum from the water closet centerline where the clearance at the water closet is 66 inches (1675 mm) minimum measured perpendicular from the rear wall.

*Figure 33.17.2.3.2 (Exception) Overlap of Water Closet Clearance in Residential Dwelling Units*

**Advisory 33.17.2.3.2 Overlap.** When the door to the toilet room is placed directly in front of the water closet, the water closet cannot overlap the required maneuvering clearance for the door inside the room.

**37.5.2.4 SEATS**

The seat height of a water closet above the finish floor shall be 17 inches (430 mm) minimum and 19 inches (485 mm) maximum measured to the top of the seat. Seats shall not be sprung to return to a lifted position.

**EXCEPTIONS:**

1. *A water closet in a toilet room for a single occupant accessed only through a private office and not for common use or public use shall not be required to comply with 33.17.2.4.*
2. *In residential dwelling units, the height of water closets shall be permitted to be 15 inches (380 mm) minimum and 19 inches (485 mm) maximum above the finish floor measured to the top of the seat.*

**37.5.2.5 GRAB BARS**

Grab bars for water closets shall comply with 33.17.13. Grab bars shall be provided on the side wall closest to the water closet and on the rear wall.

**EXCEPTIONS:**

1. *Grab bars shall not be required to be installed in a toilet room for a single occupant accessed only through a private office and not for common use or public use provided that reinforcement has been installed in walls and located so as to permit the installation of grab bars complying with 33.17.2.5.*
2. *In residential dwelling units, grab bars shall not be required to be installed in toilet or bathrooms provided that reinforcement has been installed in walls and located so as to permit the installation of grab bars complying with 33.17.2.5.*
3. *In detention or correction facilities, grab bars shall not be required to be installed in housing or holding cells that are specially designed without protrusions for purposes of suicide prevention.*

**Advisory 33.17.2.5 Grab Bars Exception 2.** Reinforcement must be sufficient to permit the installation of rear and side wall grab bars that fully meet all accessibility requirements including, but not limited to, required length, installation height, and structural strength.

**37.5.2.5.1 Side Wall**

The side wall grab bar shall be 42 inches (1065 mm) long minimum, located 12 inches (305 mm) maximum from the rear wall and extending 54 inches (1370 mm) minimum from the rear wall.

## 33.17.2.5.1 Side Wall.

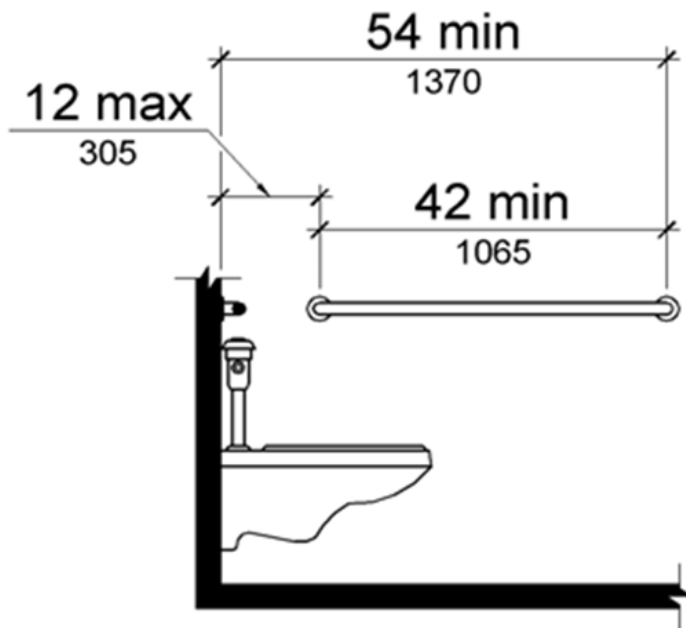

The side wall grab bar shall be 42 inches (1065 mm) long minimum, located 12 inches (305 mm) maximum from the rear wall and extending 54 inches (1370 mm) minimum from the rear wall.

**Figure 33.17.2.5.1 Side Wall Grab Bar at Water Closets**

**Advisory 33.17.2.6 Flush Controls.** *If plumbing valves are located directly behind the toilet seat, flush valves and related plumbing can cause injury or imbalance when a person leans back against them. To prevent causing injury or imbalance, the plumbing can be located behind walls or to the side of the toilet; or if approved by the local authority having jurisdiction, provide a toilet seat lid.*

## 33.17.2.5.2 Rear Wall.

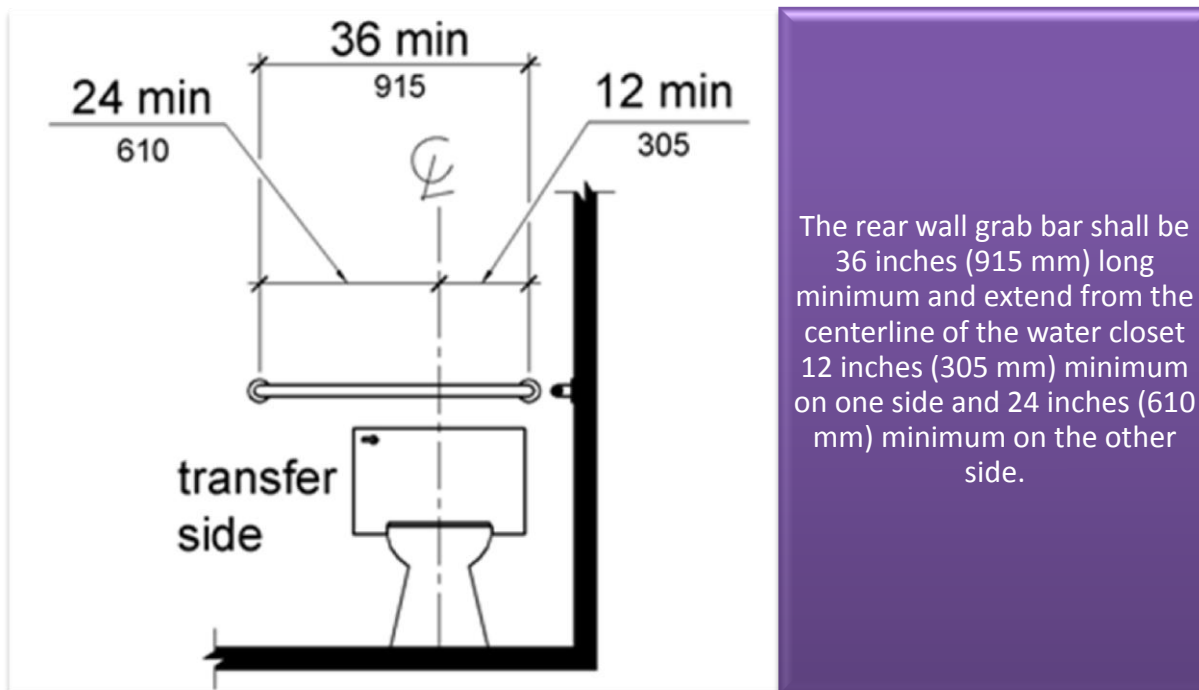

**Figure 33.17.2.5.2 Rear Wall Grab Bar at Water Closets**

**EXCEPTIONS:**

1. The rear grab bar shall be permitted to be 24 inches (610 mm) long minimum centered on the water closet, where wall *space* does not permit a length of 36 inches (915 mm) minimum due to the location of a recessed fixture adjacent to the water closet.
2. Where an *administrative authority* requires flush controls for flush valves to be located in a position that conflicts with the location of the rear grab bar, then the rear grab bar shall be permitted to be split or shifted to the open side of the toilet area.

**37.5.2.6 FLUSH CONTROLS**

Flush controls shall be hand operated or automatic. Hand operated flush controls shall comply with 309 of the ADA Standards. Flush controls shall be located on the open side of the water closet except in ambulatory *accessible* compartments complying with 604.8.2 of the ADA Standards.

## 33.17.2.7 Dispensers.

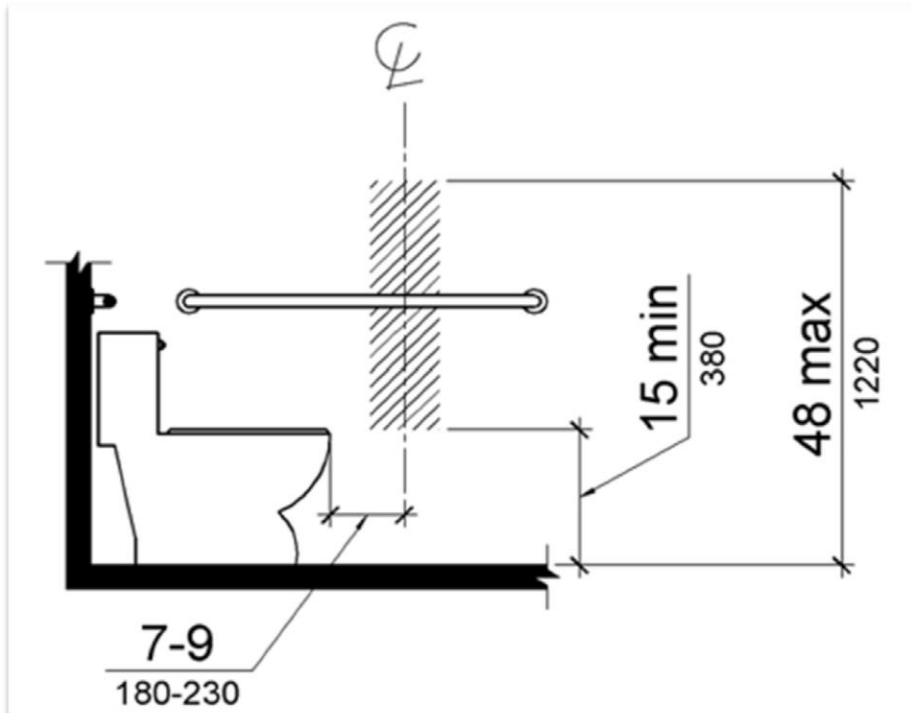

**Figure 33.17.2.7 Dispenser Outlet Location**

Toilet paper dispensers shall comply with 309.4 of the ADA Standards and shall be 7 inches (180 mm) minimum and 9 inches (230 mm) maximum in front of the water closet measured to the centerline of the dispenser. The outlet of the dispenser shall be 15 inches (380 mm) minimum and 48 inches (1220 mm) maximum above the finish floor and shall not be located behind grab bars. Dispensers shall not be of a type that controls delivery or that does not allow continuous paper flow.

**Advisory 33.17.2.7 Dispensers.** If toilet paper dispensers are installed above the side wall grab bar, the outlet of the toilet paper dispenser must be 48 inches (1220 mm) maximum above the finish floor and the top of the gripping surface of the grab bar must be 33 inches (840 mm) minimum and 36 inches (915 mm) maximum above the finish floor.

### 37.5.3 LAVATORIES AND SINKS

#### 37.5.3.1 GENERAL

Lavatories and sinks shall comply with 33.17.3.

**Advisory 33.17.3.1 General.** If soap and towel dispensers are provided, they must be located within the reach ranges specified in 308. Locate soap and towel dispensers so that they are conveniently usable by a person at the accessible lavatory.

### 37.5.3.2 CLEAR FLOOR SPACE

A clear floor *space* complying with 33.14.3.5-33.14.4.2, positioned for a forward approach, and knee and toe clearance complying with 306 of the ADA Standards shall be provided.

#### **EXCEPTIONS:**

1. A parallel approach complying with 33.14.3.5-33.14.4.3 shall be permitted to a kitchen sink in a *space* where a cook top or conventional range is not provided and to wet bar.
2. A lavatory in a toilet room or bathing *facility* for a single occupant accessed only through a private office and not for *common use* or *public use* shall not be required to provide knee and toe clearance complying with 306 of the ADA Standards.
3. In *residential dwelling units*, cabinetry shall be permitted under lavatories and kitchen sinks provided that all of the following conditions are met:
  - (a) *the cabinetry can be removed without removal or replacement of the fixture;*
  - (b) *the finish floor extends under the cabinetry; and*
  - (c) *the walls behind and surrounding the cabinetry are finished.*
4. A knee clearance of 24 inches (610 mm) minimum above the finish floor or ground shall be permitted at lavatories and sinks used primarily by children 6 through 12 years where the rim or counter surface is 31 inches (785 mm) maximum above the finish floor or ground.
5. A parallel approach complying with 33.14.3.5-33.14.4.3 shall be permitted to lavatories and sinks used primarily by children 5 years and younger.
6. The dip of the overflow shall not be considered in determining knee and toe clearances.
7. No more than one bowl of a multi-bowl sink shall be required to provide knee and toe clearance complying with 306 of the ADA Standards.

### 37.5.3.3 HEIGHT

Lavatories and sinks shall be installed with the front of the higher of the rim or counter surface 34 inches (865 mm) maximum above the finish floor or ground.

#### **EXCEPTIONS:**

1. A lavatory in a toilet or bathing *facility* for a single occupant accessed only through a private office and not for *common use* or *public use* shall not be required to comply with 33.17.3.3.
2. In *residential dwelling unit* kitchens, sinks that are adjustable to variable heights, 29 inches (735mm) minimum and 36 inches (915 mm) maximum, shall be permitted where rough-in plumbing permits connections of supply and drain pipes for sinks mounted at the height of 29 inches (735mm).

### 37.5.3.4 FAUCETS

Controls for faucets shall comply with 309 of the ADA Standards. Hand-operated metering faucets shall remain open for 10 seconds minimum.

### 37.5.3.5 EXPOSED PIPES AND SURFACES

Water supply and drain pipes under lavatories and sinks shall be insulated or otherwise configured to protect against contact. There shall be no sharp or abrasive surfaces under lavatories and sinks.



### 37.5.4 BATHTUBS

#### 37.5.4.1 GENERAL

Bathtubs shall comply with 33.17.4.

**33.17.4.2 Clearance.** Clearance in front of bathtubs shall extend the length of the bathtub and shall be 30 inches (760 mm) wide minimum. A lavatory complying with 33.17.3 shall be permitted at the control end of the clearance. Where a permanent seat is provided at the head end of the bathtub, the clearance shall extend 12 inches (305 mm) minimum beyond the wall at the head end of the bathtub

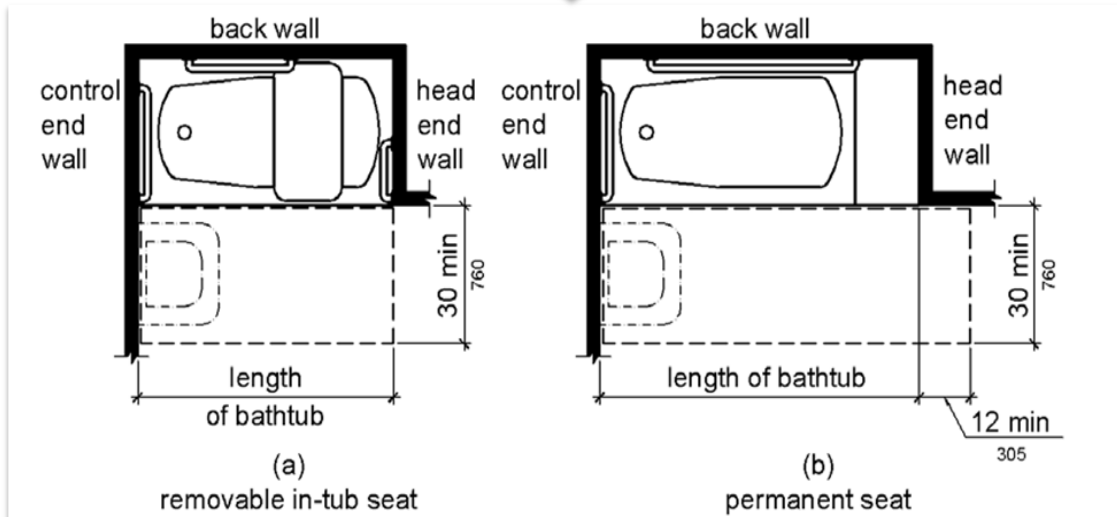

#### 37.5.4.3 SEAT

A permanent seat at the head end of the bathtub or a removable in-tub seat shall be provided. Seats shall comply with 33.17.14.

#### 37.5.4.4 GRAB BARS

Grab bars for bathtubs shall comply with 33.17.13 and shall be provided in accordance with 33.17.4.4.1 or 33.17.4.4.2.

#### **EXCEPTIONS:**

1. Grab bars shall not be required to be installed in a bathtub located in a bathing *facility* for a single occupant accessed only through a private office and not for *common use* or *public use* provided that reinforcement has been installed in walls and located so as to permit the installation of grab bars complying with 33.17.4.4.
2. In *residential dwelling units*, grab bars shall not be required to be installed in bathtubs located in bathing *facilities* provided that reinforcement has been installed in walls and located so as to permit the installation of grab bars complying with 33.17.4.4.

**37.5.4.4.1 Bathtubs With Permanent Seats**

For bathtubs with permanent seats, grab bars shall be provided in accordance with 33.17.4.4.1.

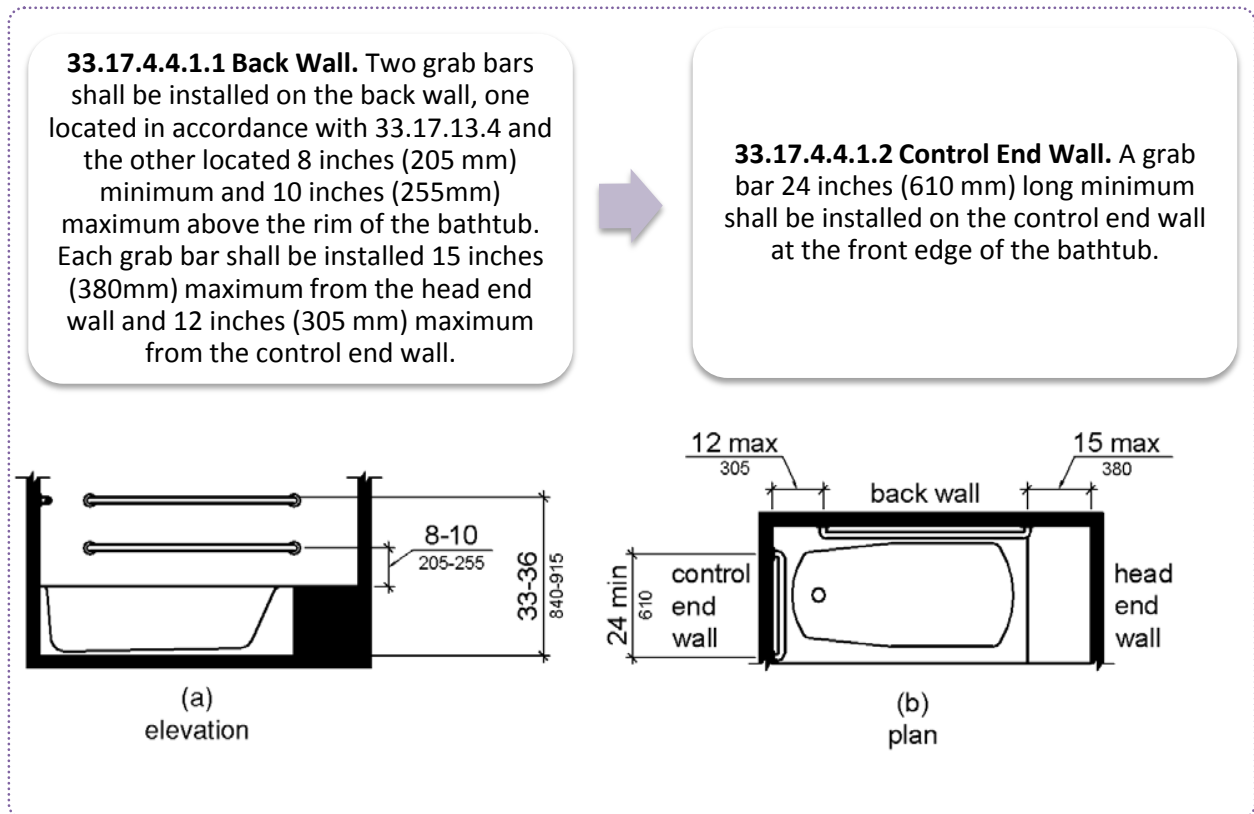

**Figure 33.17.4.4.1 Grab Bars for Bathtubs with Permanent Seats**

**37.5.4.4.2 Bathtubs Without Permanent Seats**

For bathtubs without permanent seats, grab bars shall comply with 33.17.4.4.2.

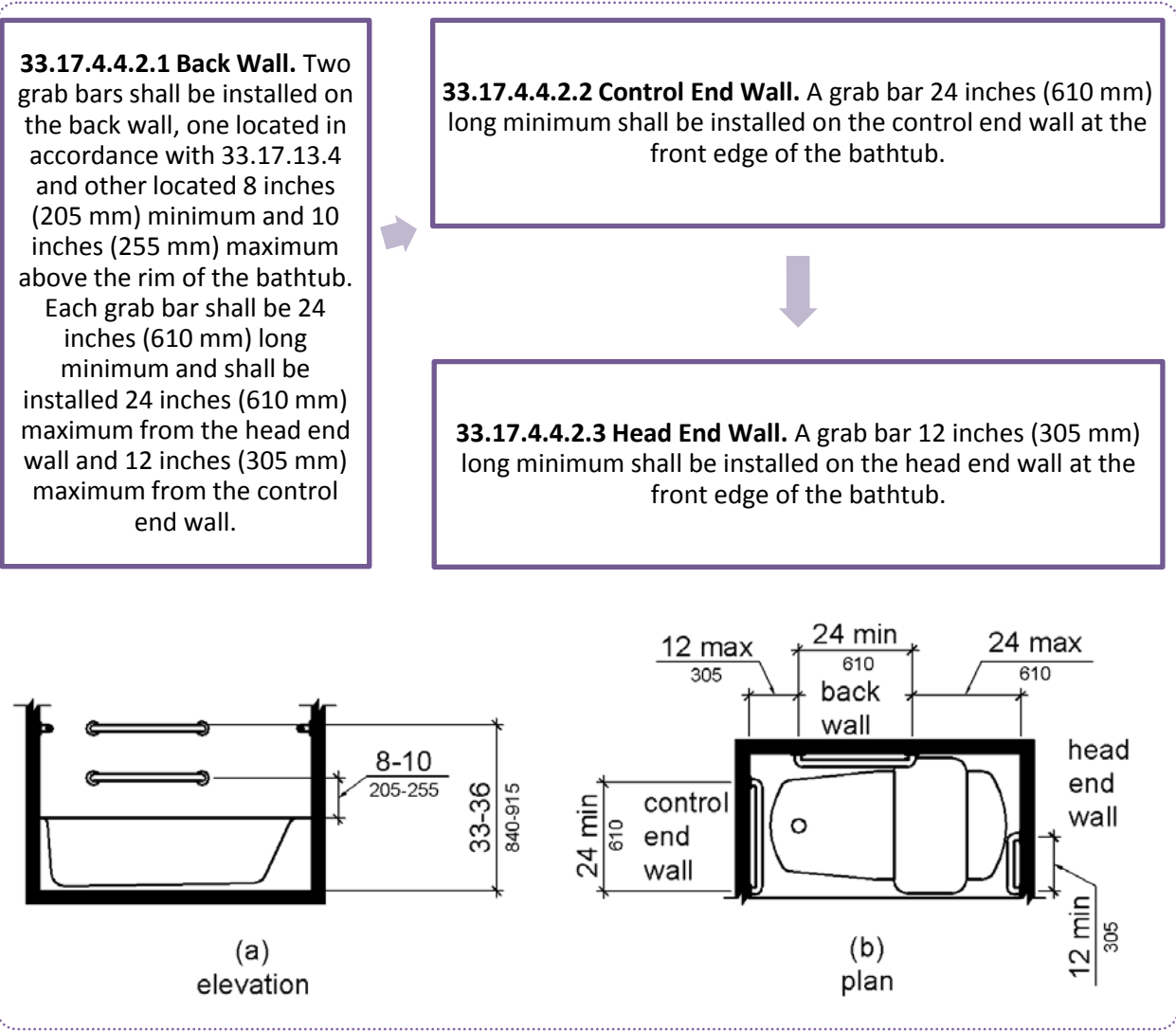

**Figure 33.17.4.2 Grab Bars for Bathtubs with Removable In-Tub Seats**

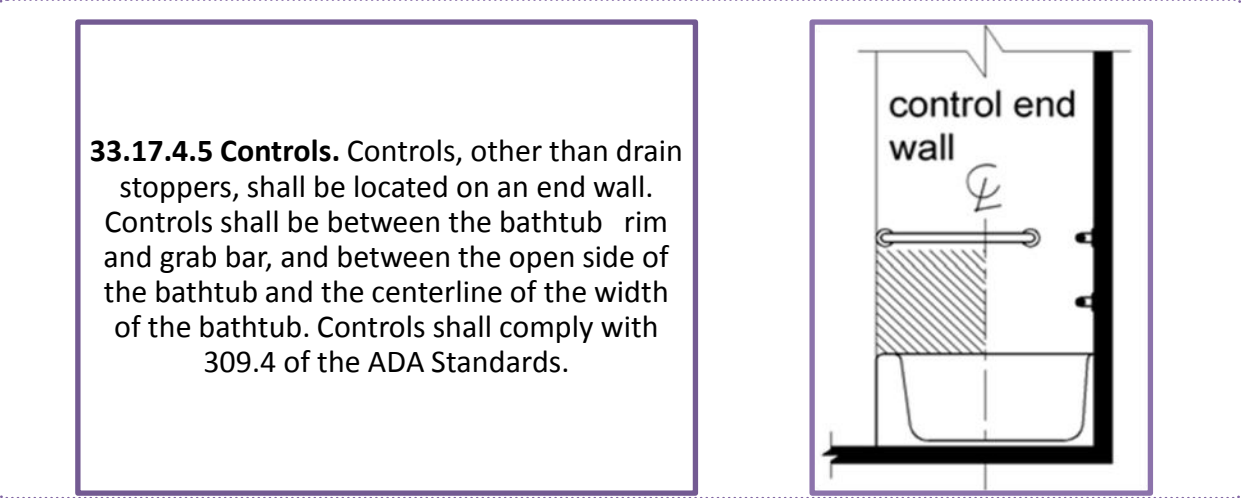

**Figure 33.17.5 Bathtub Control Location**

### 37.5.4.5 CONTROLS

#### 37.5.4.6 SHOWER SPRAY UNIT AND WATER

A shower spray unit with a hose 59 inches (1500 mm) long minimum that can be used both as a fixed-position shower head and as a hand-held shower shall be provided. The shower spray unit shall have an on/off control with a non-positive shut-off. If an adjustable-height shower head on a vertical bar is used, the bar shall be installed so as not to obstruct the use of grab bars. Bathtub shower spray units shall deliver water that is 120°F (49°C) maximum.

**Advisory 33.17.4.6 Shower Spray Unit and Water.** *Ensure that hand-held shower spray units are capable of delivering water pressure substantially equivalent to fixed shower heads.*

#### 37.5.4.7 BATHTUB ENCLOSURES

Enclosures for bathtubs shall not obstruct controls, faucets, shower and spray units or obstruct transfer from wheelchairs onto bathtub seats or into bathtubs. Enclosures on bathtubs shall not have tracks installed on the rim of the open face of the bathtub.

### 37.5.5 SHOWER COMPARTMENTS

#### 37.5.5.1 GENERAL

Shower compartments shall comply with 33.17.5-33.17.12.

**Advisory 33.17.5.1 General.** *Shower stalls that are 60 inches (1525 mm) wide and have no curb may increase the usability of a bathroom because the shower area provides additional maneuvering space.*

**33.17.5.2.1 Transfer Type Shower Compartments.** Transfer type shower compartments shall be 36 inches (915 mm) by 36 inches (915 mm) clear inside dimensions measured at the center points of opposing sides and shall have a 36 inch (915 mm) wide minimum entry on the face of the shower compartment. Clearance of 36 inches (915 mm) wide minimum by 48 inches (1220 mm) long minimum measured from the control wall shall be provided



**33.17.5.2 Size and Clearances for Shower Compartments.** Shower compartments shall have sizes and clearances complying with 33.17.5.2 and 33.17.6.

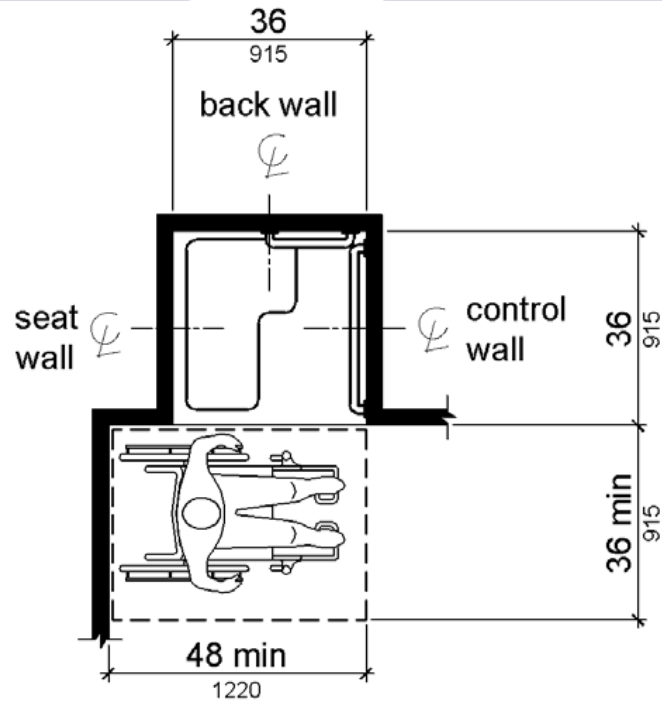

Note: inside finished dimensions measured at the center points of opposing sides

**Figure 33.17.5.2.1 Transfer Type Shower Compartment Size and Clearance**

**37.5.6 STANDARD ROLL-IN TYPE SHOWER COMPARTMENTS**

**33.17.6.1 Standard Roll-In Type Shower Compartments.** Standard roll-in type shower compartments shall be 30 inches (760 mm) wide minimum by 60 inches (1525 mm) deep minimum clear inside dimensions measured at center points of opposing sides and shall have a 60 inches (1525 mm) wide minimum entry on the face of the shower compartment

**33.17.6.1.2 Clearance.** A 30 inch (760 mm) wide minimum by 60 inch (1525 mm) long minimum clearance shall be provided adjacent to the open face of the shower compartment.

**EXCEPTION:** A lavatory complying with 33.17.3 shall be permitted on one 30 inch (760 mm) wide minimum side of the clearance provided that it is not on the side of the clearance adjacent to the controls or, where provided, not on the side of the clearance adjacent to the shower seat.

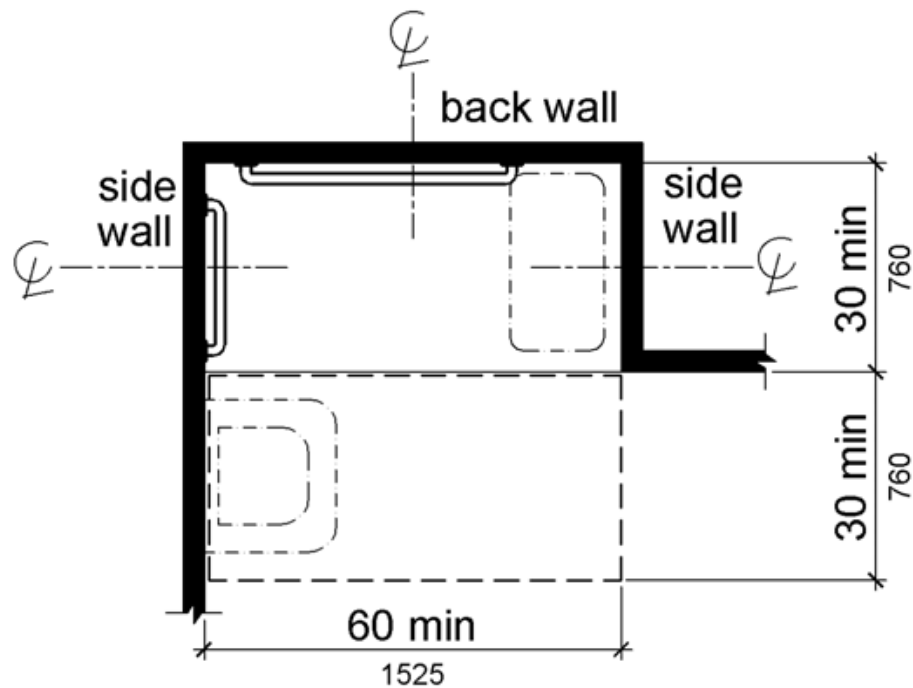

Note: inside finished dimensions measured at the center points of opposing sides

**Figure 33.17.6.1 Standard Roll-In Type Shower Compartment Size and Clearance**

### 33.17.6.2 Alternate Roll-In Type Shower Compartments.

Alternate roll-in type shower compartments shall be 36 inches (915 mm) wide and 60 inches (1525 mm) deep minimum clear inside dimensions measured at center points of opposing sides. A 36 inch (915 mm) wide minimum entry shall be provided at one end of the long side of the compartment.

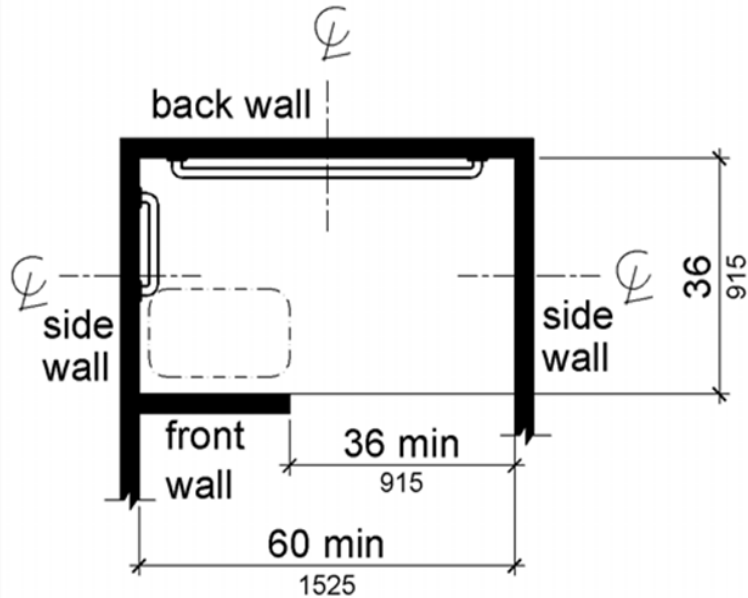

Note: inside finished dimensions measured at the center points of opposing sides

**Figure 33.17.6.2 Alternate Roll-In Type Shower Compartment Size and Clearance**

## 37.5.7 ALTERNATE ROLL-IN TYPE SHOWER COMPARTMENTS

### 37.5.7.1 GRAB BARS

Grab bars shall comply with 33.17.13 and shall be provided in accordance with 33.17.7.1. Where multiple grab bars are used, required horizontal grab bars shall be installed at the same height above the finish floor.

#### **EXCEPTIONS:**

1. Grab bars shall not be required to be installed in a shower located in a bathing *facility* for a single occupant accessed only through a private office, and not for *common use* or *public use* provided that reinforcement has been installed in walls and located so as to permit the installation of grab bars complying with 33.17.7.1.
2. In *residential dwelling units*, grab bars shall not be required to be installed in showers located in bathing *facilities* provided that reinforcement has been installed in walls and located so as to permit the installation of grab bars complying with 33.17.7.1.

**37.5.8 TRANSFER TYPE SHOWER COMPARTMENTS**

**33.17.8.1 Transfer Type Shower Compartments.** In transfer type compartments, grab bars shall be provided across the control wall and back wall to a point 18 inches (455 mm) from the control wall.

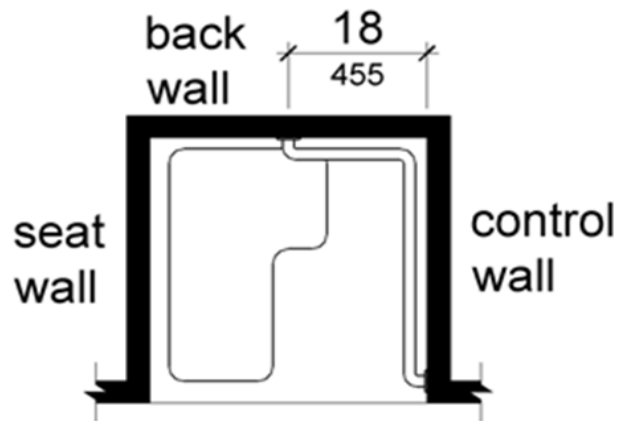

*Figure 33.17.8.1 Grab Bars for Transfer Type Showers*

**37.5.9 STANDARD ROLL-IN TYPE SHOWER COMPARTMENTS**

**33.17.9.1 Standard Roll-In Type Shower Compartments.** Where a seat is provided in standard roll-in type shower compartments, grab bars shall be provided on the back wall and the side wall opposite the seat. Grab bars shall not be provided above the seat. Where a seat is not provided in standard roll-in type shower compartments, grab bars shall be provided on three walls. Grab bars shall be installed 6 inches (150 mm) maximum from adjacent walls.

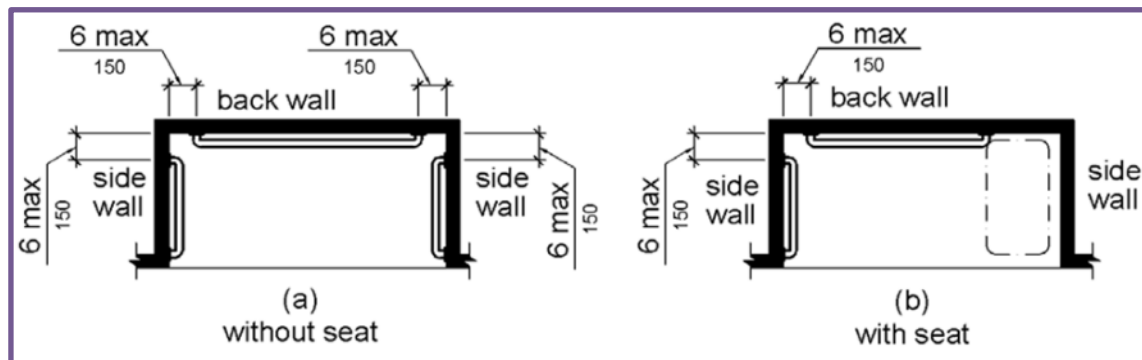
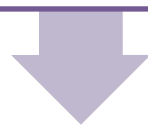
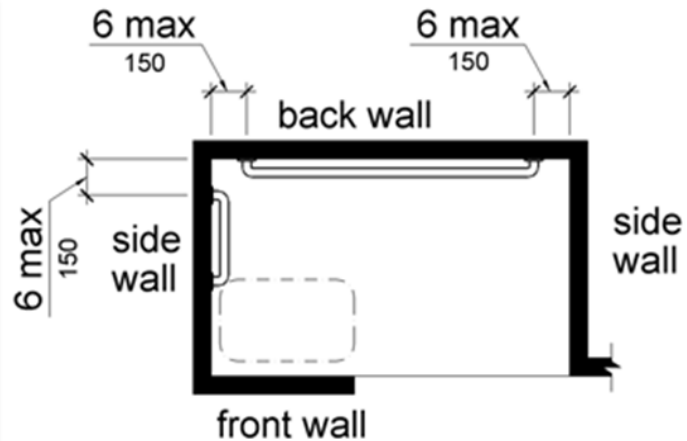

*Figure 33.17.9.1 Grab Bars for Standard Roll-In Type Showers*



**37.5.10 ALTERNATE ROLL-IN TYPE SHOWER COMPARTMENTS****33.17.10.1 Alternate Roll-In Type Shower Compartments.**

In alternate roll-in type shower compartments, grab bars shall be provided on the back wall and the side wall farthest from the compartment entry. Grab bars shall not be provided above the seat. Grab bars shall be installed 6 inches (150 mm) maximum from adjacent walls.



*Figure 33.17.10.1 Grab Bars for Alternate Roll-In Type Showers*

**37.5.11 SEATS****37.5.11.1 SEATS**

A folding or non-folding seat shall be provided in transfer type shower compartments. A folding seat shall be provided in roll-in type showers required in *transient lodging* guest rooms with mobility features complying with 806.2 of the ADA Standards. Seats shall comply with 33.17.4.

**EXCEPTION:** In *residential dwelling units*, seats shall not be required in transfer type shower compartments provided that reinforcement has been installed in walls so as to permit the installation of seats complying with 33.17.11.1.

**37.5.11.2 CONTROLS**

Controls, faucets, and shower spray units shall comply with 309.4 of the ADA Standards.

**37.5.12 TRANSFER TYPE SHOWER COMPARTMENTS****37.5.12.1 TRANSFER TYPE SHOWER COMPARTMENTS**

In transfer type shower compartments, the controls, faucets, and shower spray unit shall be installed on the side wall opposite the seat 38 inches (965 mm) minimum and 48 inches (1220 mm) maximum above the shower floor and shall be located on the control wall 15 inches (380 mm) maximum from the centerline of the seat toward the shower opening.

**33.17.12.1 Transfer Type Shower Compartments.** In transfer type shower compartments, the controls, faucets, and shower spray unit shall be installed on the side wall opposite the seat 38 inches (965 mm) minimum and 48 inches (1220 mm) maximum above the shower floor and shall be located on the control wall 15 inches (380 mm) maximum from the centerline of the seat toward the shower opening.

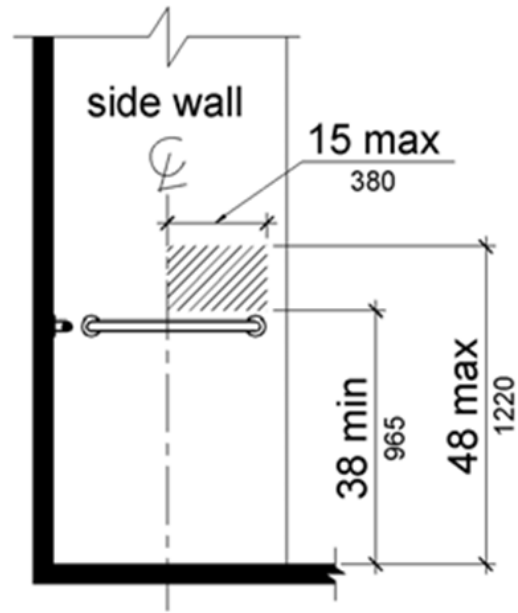

*Figure 33.17.12.1 Transfer Type Shower Compartment Control Location*

**33.17.12.1.1 Standard Roll-In Type Shower Compartments.** In standard roll-in type shower compartments, the controls, faucets, and shower spray unit shall be located above the grab bar, but no higher than 48 inches (1220 mm) above the shower floor. Where a seat is provided, the controls, faucets, and shower spray unit shall be installed on the back wall adjacent to the seat wall and shall be located 27 inches (685 mm) maximum from the seat wall.

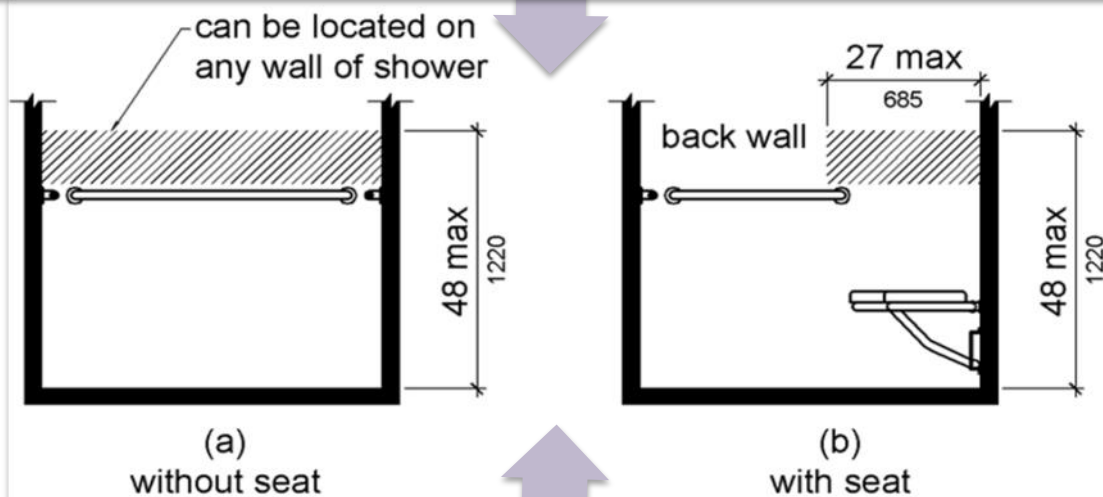

**Advisory 33.17.12.1 Standard Roll-in Type Shower Compartments.** In standard roll-in type showers without seats, the shower head and operable parts can be located on any of the three walls of the shower without adversely affecting accessibility.

*Figure 33.17.12.1.2 Standard Roll-In Type Shower Compartment Control Location*

**33.17.12.1.2 Alternate Roll-In Type Shower Compartments.** In alternate roll-in type shower compartments, the controls, faucets, and shower spray unit shall be located above the grab bar, but no higher than 48 inches (1220 mm) above the shower floor. Where a seat is provided, the controls, faucets, and shower spray unit shall be located on the side wall adjacent to the seat 27 inches (685 mm) maximum from the side wall behind the seat or shall be located on the back wall opposite the seat 15 inches (380 mm) maximum, left or right, of the centerline of the seat. Where a seat is not provided, the controls, faucets, and shower spray unit shall be installed on the side wall farthest from the compartment entry.

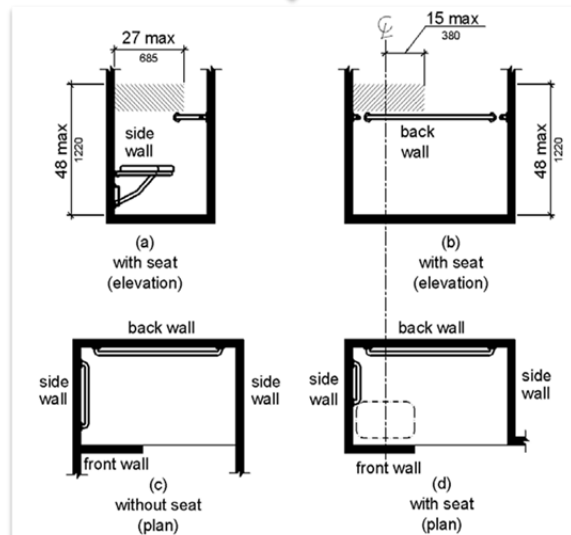

**Figure 33.17.12.1.2 Alternate Roll-In Type Shower Compartment Control Location**

#### 37.5.12.2 SHOWER SPRAY UNIT AND WATER

A shower spray unit with a hose 59 inches (1500 mm) long minimum that can be used both as a fixed-position shower head and as a hand-held shower shall be provided. The shower spray unit shall have an on/off control with a non-positive shut-off. If an adjustable-height shower head on a vertical bar is used, the bar shall be installed so as not to obstruct the use of grab bars. Shower spray units shall deliver water that is 120°F (49°C) maximum.

**Advisory 33.17.12.2 Shower Spray Unit and Water.** Ensure that hand-held shower spray units are capable of delivering water pressure substantially equivalent to fixed shower heads.

**EXCEPTION:** A fixed shower head located at 48 inches (1220 mm) maximum above the shower finish floor shall be permitted instead of a hand-held spray unit in *facilities* that are not medical care facilities, long-term care facilities, transient lodging guest rooms, or residential dwelling units.

### 37.5.12.3 THRESHOLDS

Thresholds in roll-in type shower compartments shall be ½ inch (13 mm) high maximum in accordance with 33.14.2. In transfer type shower compartments, thresholds ½ inch (13 mm) high maximum shall be beveled, rounded, or vertical.

**EXCEPTION:** A threshold 2 inches (51 mm) high maximum shall be permitted in transfer type shower compartments in existing *facilities* where provision of a ½ inch (13 mm) high threshold would disturb the structural reinforcement of the floor slab.

### 37.5.12.4 SHOWER ENCLOSURES

Enclosures for shower compartments shall not obstruct controls, faucets, and shower spray units or obstruct transfer from wheelchairs onto shower seats.

## 37.5.13 GRAB BARS

### 37.5.13.1 GENERAL

Grab bars in toilet *facilities* and bathing *facilities* shall comply with 33.17.13.

### 37.5.13.2 CROSS SECTION

Grab bars shall have a cross section complying with 33.17.13.2.1 or 33.17.13.2.2.

#### 37.5.13.2.1 Circular Cross Section

Grab bars with circular cross sections shall have an outside diameter of 1¼ inches (32 mm) minimum and 2 inches (51 mm) maximum.

**33.17.13.2.2 Non-Circular Cross Section.** Grab bars with non-circular cross sections shall have a cross-section dimension of 2 inches (51 mm) maximum and a perimeter dimension of 4 inches (100mm) minimum and 4.8 inches (120 mm) maximum.

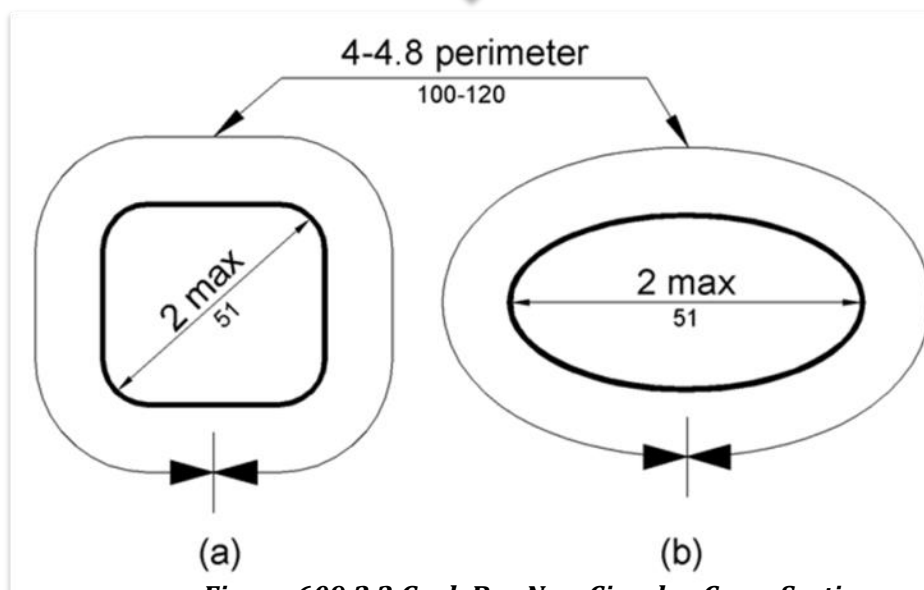

**Figure 609.2.2 Grab Bar Non-Circular Cross Section**

**33.17.13.3 Spacing.** The *space* between the wall and the grab bar shall be 1½ inches (38 mm). The *space* between the grab bar and projecting objects below and at the ends shall be 1½ inches (38 mm) minimum. The *space* between the grab bar and projecting objects above shall be 12 inches (305 mm) minimum.

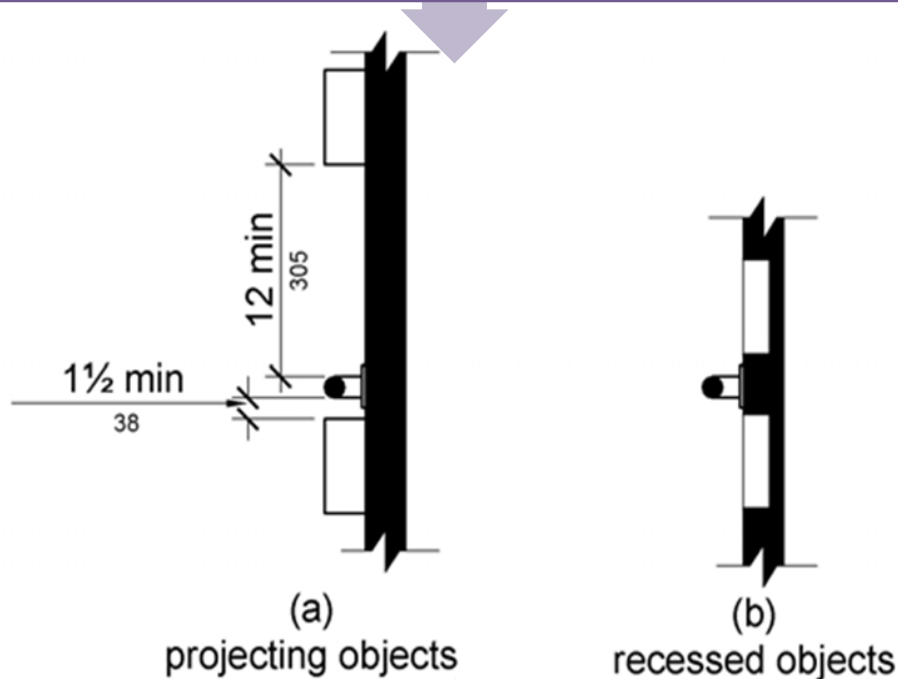

**EXCEPTION:** The *space* between the grab bars and shower controls, shower fittings, and other grab bars above shall be permitted to be 1½ inches (38 mm) minimum.

**Figure 33.17.3.3 Spacing of Grab Bars**

#### 37.5.13.4 POSITION OF GRAB BARS

Grab bars shall be installed in a horizontal position, 33 inches (840 mm) minimum and 36 inches (915 mm) maximum above the finish floor measured to the top of the gripping surface, except that at water closets for *children's use* complying with 604.9 of the ADA Standards, grab bars shall be installed in a horizontal position 18 inches (455 mm) minimum and 27 inches (685 mm) maximum above the finish floor measured to the top of the gripping surface. The height of the lower grab bar on the back wall of a bathtub shall comply with 33.17.4.4.1.1 or 33.17.4.4.2.1.

#### 37.5.13.5 SURFACE HAZARDS

Grab bars and any wall or other surfaces adjacent to grab bars shall be free of sharp or abrasive *elements* and shall have rounded edges.

### 37.5.13.6 FITTINGS

Grab bars shall not rotate within their fittings.

### 37.5.13.7 INSTALLATION

Grab bars shall be installed in any manner that provides a gripping surface at the specified locations and that does not obstruct the required clear floor *space*.

### 37.5.13.8 STRUCTURAL STRENGTH

Allowable stresses shall not be exceeded for materials used when a vertical or horizontal force of 250 pounds (1112 N) is applied at any point on the grab bar, fastener, mounting device, or supporting structure.

## 37.5.14 SEATS

### 37.5.14.1 GENERAL

Seats in bathtubs and shower compartments shall comply with 33.17.14.

**33.17.14.2 Bathtub Seats.** The top of bathtub seats shall be 17 inches (430 mm) minimum and 19 inches (485 mm) maximum above the bathroom finish floor. The depth of a removable in-tub seat shall be 15 inches (380 mm) minimum and 16 inches (405 mm) maximum. The seat shall be capable of secure placement. Permanent seats at the head end of the bathtub shall be 15 inches (380 mm) deep minimum and shall extend from the back wall to or beyond the outer edge of the bathtub.

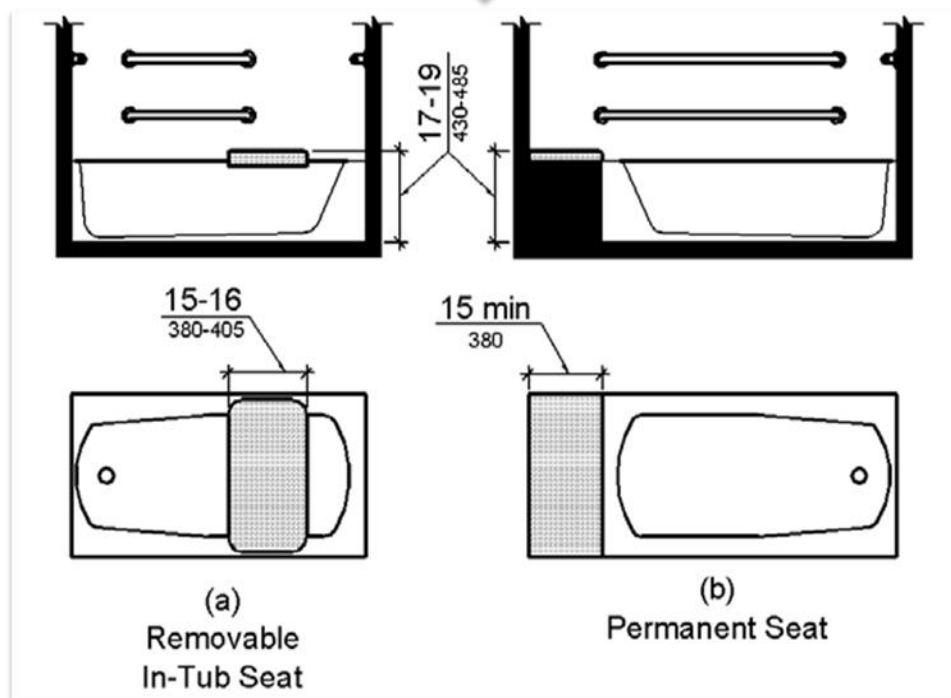
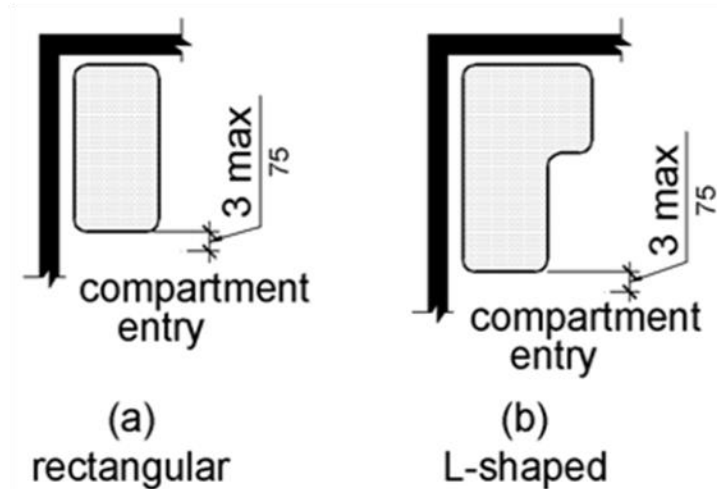

**Figure 33.17.14.2 Bathtub Seats**

**37.5.14.2 BATHTUB SEATS**

The top of bathtub seats shall be 17 inches (430 mm) minimum and 19 inches (485 mm) maximum above the bathroom finish floor. The depth of a removable in-tub seat shall be 15 inches (380 mm) minimum and 16 inches (405 mm) maximum. The seat shall be capable of secure placement. Permanent seats at the head end of the bathtub shall be 15 inches (380 mm) deep minimum and shall extend from the back wall to or beyond the outer edge of the bathtub.

**33.17.14.3 Shower Compartment Seats.** Where a seat is provided in a standard roll-in shower compartment, it shall be a folding type, shall be installed on the side wall adjacent to the controls, and shall extend from the back wall to a point within 3 inches (75 mm) of the compartment entry. Where a seat is provided in an alternate roll-in type shower compartment, it shall be a folding type, shall be installed on the front wall opposite the back wall, and shall extend from the adjacent side wall to a point within 3 inches (75 mm) of the compartment entry. In transfer-type showers, the seat shall extend from the back wall to a point within 3 inches (75 mm) of the compartment entry. The top of the seat shall be 17 inches (430 mm) minimum and 19 inches (485 mm) maximum above the bathroom finish floor. Seats shall comply with 33.17.14.3.1 or 33.17.14.3.2.



*Figure 33.17.14.3 Extent of Seat*

**33.17.14.3.1 Rectangular Seats.** The rear edge of a rectangular seat shall be  $2\frac{1}{2}$  inches (64 mm) maximum and the front edge 15 inches (380 mm) minimum and 16 inches (405 mm) maximum from the seat wall. The side edge of the seat shall be  $1\frac{1}{2}$  inches (38 mm) maximum from the adjacent wall.

*Figure 33.17.14.3.1 Rectangular Shower Seat*

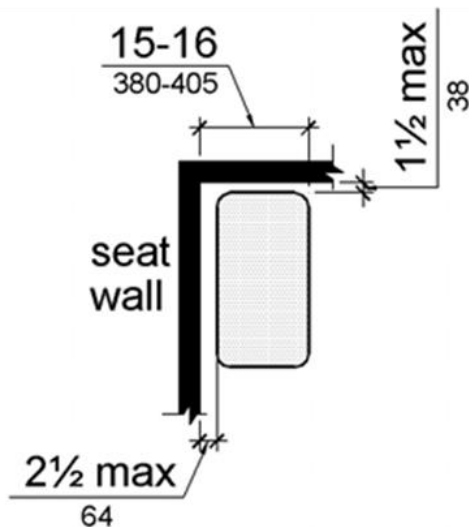

**33.17.14.3.2 L-Shaped Seats.**

The rear edge of an L-shaped seat shall be  $2\frac{1}{2}$  inches (64 mm) maximum and the front edge 15 inches (380 mm) minimum and 16 inches (405 mm) maximum from the seat wall. The rear edge of the “L” portion of the seat shall be  $1\frac{1}{2}$  inches (38 mm) maximum from the wall and the front edge shall be 14 inches (355 mm) minimum and 15 inches (380 mm) maximum from the wall. The end of the “L” shall be 22 inches (560 mm) minimum and 23 inches maximum (585 mm) from the main seat wall.

*Figure 33.17.14.3.2 L-Shaped Seat*

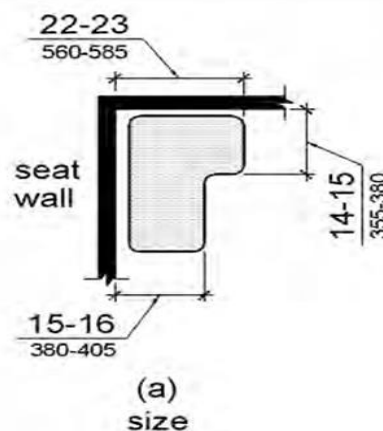

(a)  
size

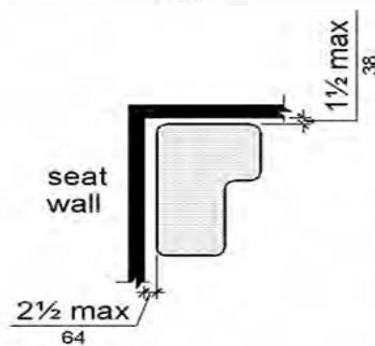

(b)  
distance from wall

**37.5.14.4 STRUCTURAL STRENGTH**

Allowable stresses shall not be exceeded for materials used when a vertical or horizontal force of 250 pounds (1112 N) is applied at any point on the seat, fastener, mounting device, or supporting structure.



**37.5.15 WASHING MACHINES AND CLOTHES DRYERS****37.5.15.1 GENERAL**

Washing machines and clothes dryers shall comply with 33.17.15.

**37.5.15.2 CLEAR FLOOR SPACE**

A clear floor or ground *space* complying with 33.14.3.5-33.14.4.3 positioned for parallel approach shall be provided. The clear floor or ground *space* shall be centered on the appliance.

**37.5.15.3 OPERABLE PARTS**

*Operable parts*, including doors, lint screens, and detergent and bleach compartments shall comply with 309 of the ADA Standards.

**37.5.15.4 HEIGHT**

Top loading machines shall have the door to the laundry compartment located 36 inches (915 mm) maximum above the finish floor. Front loading machines shall have the bottom of the opening to the laundry compartment located 15 inches (380 mm) minimum and 36 inches (915 mm) maximum above the finish floor.

**33.17.14.4 Height.** Top loading machines shall have the door to the laundry compartment located 36 inches (915 mm) maximum above the finish floor. Front loading machines shall have the bottom of the opening to the laundry compartment located 15 inches (380 mm) minimum and 36 inches (915 mm) maximum above the finish floor.

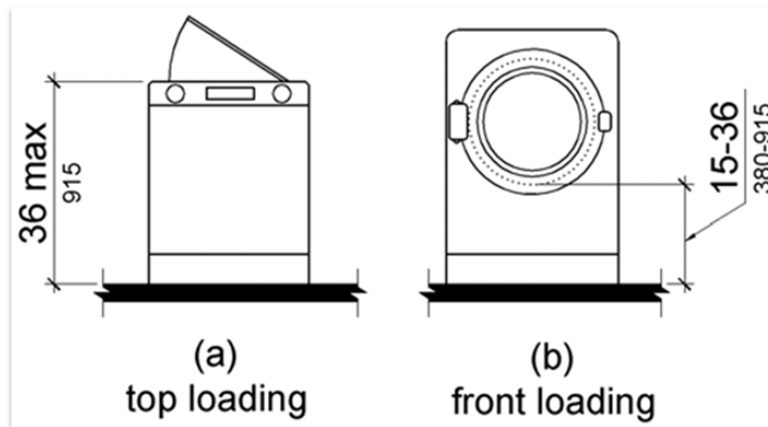

**Figure 33.17.15.4 Height of Laundry Compartment Opening**

**37.6 SPECIAL ROOMS AND SPACES**

Where a kitchen is provided, it shall comply with 33.18.1-33.18.6, and 804.7-804.9 of the ADA Standards.

**37.6.1 GENERAL**

Kitchens and kitchenettes shall comply with 33.18.1-33.18.6.

**37.6.2 CLEARANCE**

Where a pass through kitchen is provided, clearances shall comply with 33.18.2.1. Where a U-shaped kitchen is provided, clearances shall comply with 33.18.2.2.

**EXCEPTION:** *Spaces* that do not provide a cook-top or conventional range shall not be required to comply with 33.18.2.

**Advisory 33.18.2 Clearance.** *Clearances are measured from the furthest projecting face of all opposing base cabinets, counter tops, appliances, or walls, excluding hardware.*

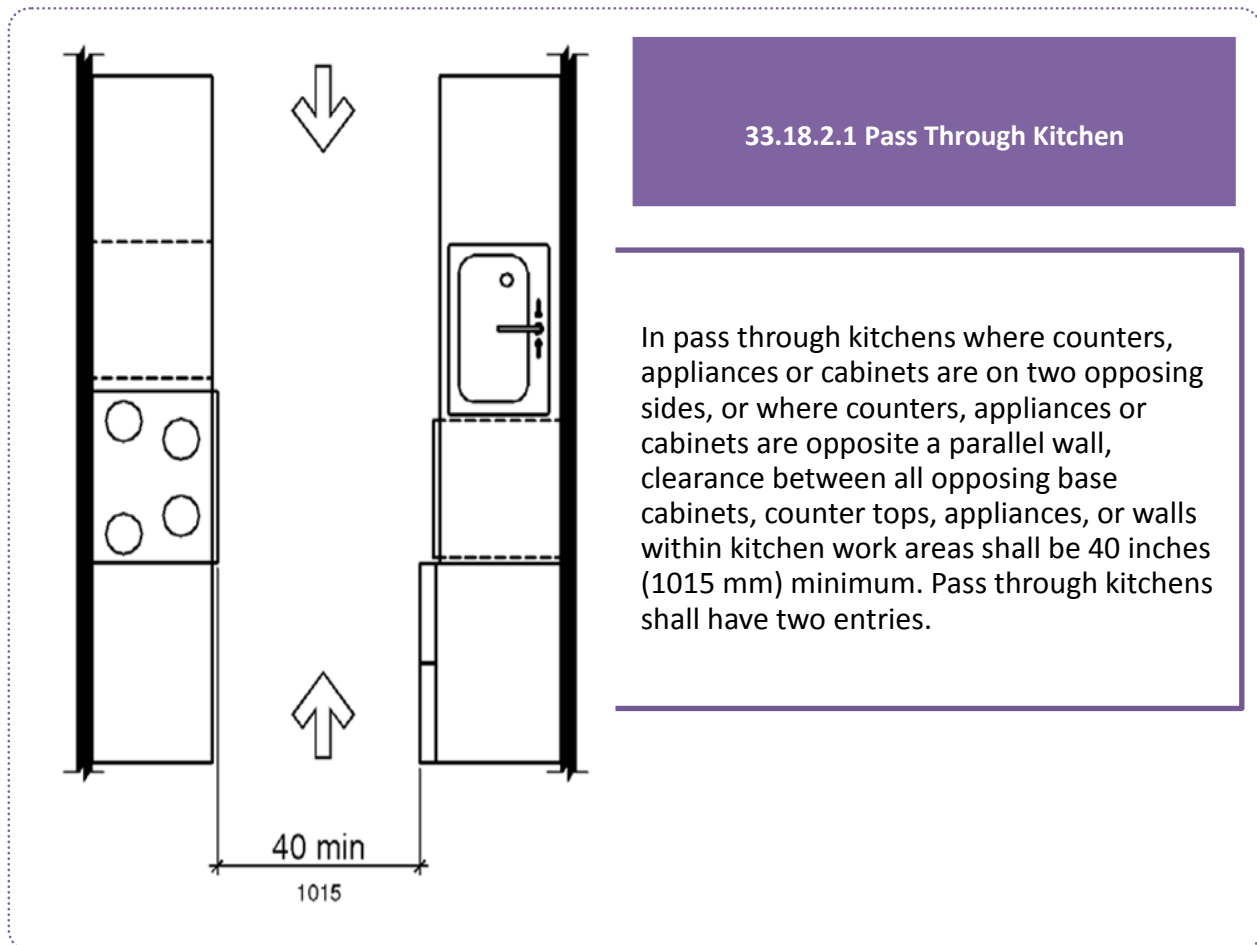

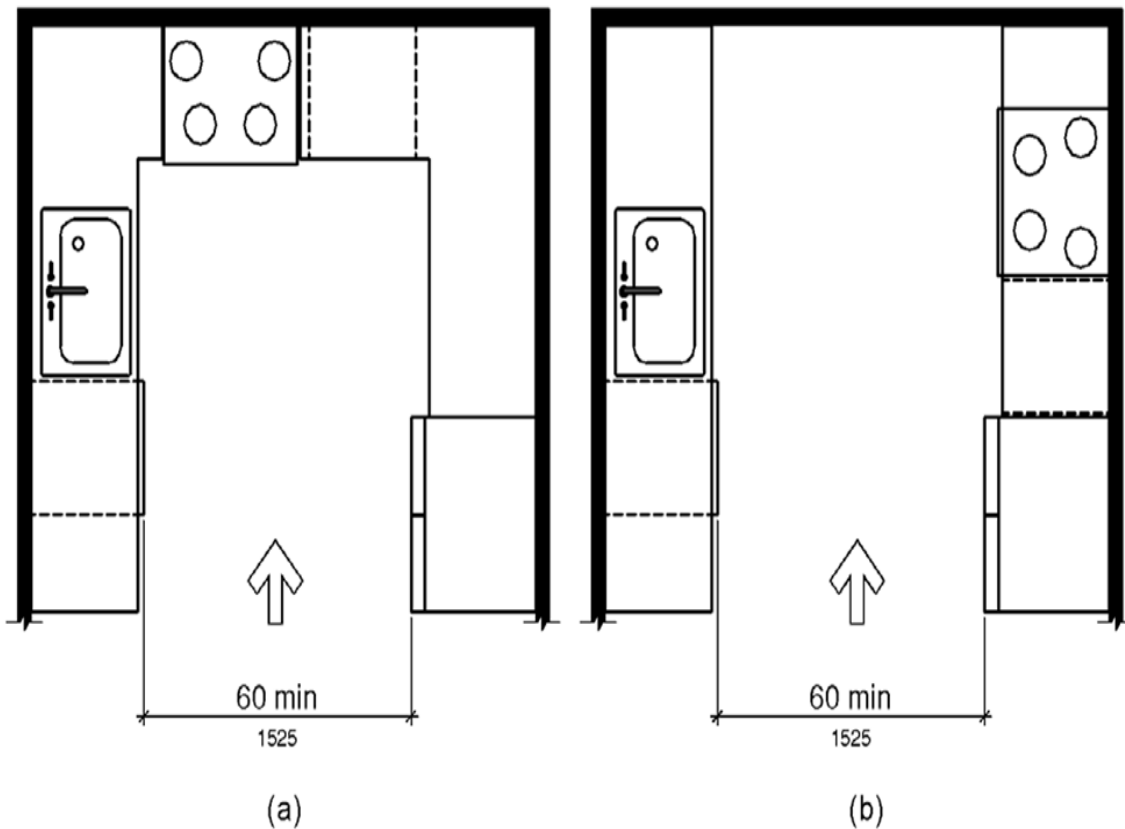

**33.18.2.2 U-Shaped.** In U-shaped kitchens enclosed on three contiguous sides, clearance between all opposing base cabinets, counter tops, appliances, or walls within kitchen work areas shall be 60 inches (1525 mm) minimum

**Figure 33.18.2.2 U-Shaped Kitchens**

### 37.6.3 KITCHEN WORK SURFACE

In residential dwelling units required to comply with 809 of the ADA Standards, at least one 30 inches (760 mm) wide minimum section of counter shall provide a kitchen work surface that complies with 33.18.3.

#### 37.6.3.1 CLEAR FLOOR OR GROUND SPACE

A clear floor space complying with 33.14.3.4-33.14.4.2 positioned for a forward approach shall be provided. The clear floor or ground space shall be centered on the kitchen work surface and shall provide knee and toe clearance complying with 306 of the ADA Standards.

**EXCEPTION:** Cabinetry shall be permitted under the kitchen work surface provided that all of the following conditions are met:

- a) the cabinetry can be removed without removal or replacement of the kitchen work surface;
- b) the finish floor extends under the cabinetry; and
- c) the walls behind and surrounding the cabinetry are finished.

**37.6.3.2 HEIGHT**

The kitchen work surface shall be 34 inches (865 mm) maximum above the finish floor or ground.

**EXCEPTION:** A counter that is adjustable to provide a kitchen work surface at variable heights, 29 inches (735 mm) minimum and 36 inches (915 mm) maximum, shall be permitted.

**37.6.3.3 EXPOSED SURFACES**

There shall be no sharp or abrasive surfaces under the work surface counters.

**37.6.4 SINKS**

Sinks shall comply with 33.17.3.

**37.6.5 STORAGE**

At least 50 percent of shelf *space* in storage *facilities* shall comply with 811 of the ADA Standards.

**37.6.6 APPLIANCES**

Where provided, kitchen appliances shall comply with 33.18.6.

**37.6.6.1 CLEAR FLOOR OR GROUND SPACE**

A clear floor or ground *space* complying with 33.14.3.5-33.14.4.3 shall be provided at each kitchen appliance. Clear floor or ground *spaces* shall be permitted to overlap.

**37.6.6.2 OPERABLE PARTS**

All appliance controls shall comply with 309 of the ADA Standards.

**EXCEPTIONS:**

1. Appliance doors and door latching devices shall not be required to comply with 309.4.
2. Bottom-hinged appliance doors, when in the open position, shall not be required to comply with 309.3 of the ADA Standards.

**37.6.6.3 DISHWASHER**

Clear floor or ground *space* shall be positioned adjacent to the dishwasher door. The dishwasher door, in the open position, shall not obstruct the clear floor or ground *space* for the dishwasher or the sink.

**37.6.6.4 RANGE OR COOKTOP**

Where a forward approach is provided, the clear floor or ground *space* shall provide knee and toe clearance complying with 306 of the ADA Standards. Where knee and toe *space* is provided, the underside of the range or cooktop shall be insulated or otherwise configured to prevent burns, abrasions, or electrical shock. The location of controls shall not require reaching across burners.

**37.6.6.5 OVEN**

Ovens shall comply with 33.18.6.5.

**37.6.6.5.1 Side-Hinged Door Ovens**

Side-hinged door ovens shall have the work surface required by 33.18.3 positioned adjacent to the latch side of the oven door.

**37.6.6.5.2 Bottom-Hinged Door Ovens**

Bottom-hinged door ovens shall have the work surface required by 33.18.3 positioned adjacent to one side of the door.

**37.6.6.5.3 Controls**

Ovens shall have controls on front panels.

**37.6.6.6 REFRIGERATOR/FREEZER**

Combination refrigerators and freezers shall have at least 50 percent of the freezer *space* 54 inches (1370 mm) maximum above the finish floor or ground. The clear floor or ground *space* shall be positioned for a parallel approach to the *space* dedicated to a refrigerator/ freezer with the centerline of the clear floor or ground *space* offset 24 inches (610 mm) maximum from the centerline of the dedicated *space*.

**37.6.7 TOILET FACILITIES AND BATHING FACILITIES**

At least one bathroom shall comply with 33.17.1. No fewer than one of each type of fixture provided shall comply with applicable requirements of 33.17.1-33.17.4.

**37.7 OTHER RECOMMENDATIONS TO MAKE A RESIDENCE ACCESSIBLE (NOT MANDATORY)**

<p><b>Door Handles; Doorways</b></p> <ul style="list-style-type: none"> <li>• Door locks that are easy to operate, keyless locks with a remote control or keypad</li> <li>• Lever style door handles vs. round ball type handles</li> <li>• Doorways that are 36 inches wide (if making the doorway wider is not an option, clear swing hinges can help you gain a couple of inches)</li> </ul>	<p><b>Kitchens and Laundry</b></p> <ul style="list-style-type: none"> <li>• Easy access to kitchen storage; pull out shelves, lazy susans in corners</li> <li>• Appliances with controls that are large, easy to read &amp; ones that have large push pads</li> <li>• Microwave placed on counter, never above stove</li> <li>• A side-by-side refrigerator/freezer combination gives the user easy access</li> <li>• Stove with controls in the front</li> <li>• Good lighting over stove, sink &amp; other work areas, under cabinet lighting</li> <li>• Raised dishwasher &amp; oven</li> <li>• Lowered kitchen cabinets &amp; adjustable shelves in closets</li> <li>• Increase overall illumination; good lighting over stove, sink &amp; other work areas, under cabinet lighting</li> <li>• Laundry on main floor, front loading washer &amp; dryer</li> </ul>	<p><b>Bathrooms</b></p> <ul style="list-style-type: none"> <li>• Use anti-scald faucets (sometimes called even flow) to make water temperatures even</li> <li>• Turn water temperature down to 120 degrees</li> <li>• Use single lever faucets in sinks, tubs, &amp; showers</li> <li>• Adjustable-height, handheld showerhead</li> <li>• Reinforced grab bars in the bath &amp; shower &amp; reinforced walls to allow grab bars near the toilet</li> <li>• Accessible toilet – seat is higher than regular toilet seat</li> <li>• Telephone jack in the bathroom &amp; one near the bed</li> </ul>
---	---	--

**Flooring and Stairs**

- Use of sheet vinyl or low pile carpeting on floors
- Eliminate throw rugs
- Eliminate open risers on stairs & stairs that have nosings
- Anti-slip strips on the front edge of steps in a contrasting material
- Sturdy handrails on both sides of stairs
- Eliminate thresholds or minimize them by adding a piece to the threshold so that the foot will glide over it

**Equipment; Phones, Alarms, Televisions, and Stereos**

- Phones with large numbers; some phones have pictures of the person that you are calling
- Doorbells, smoke alarms, & telephones that blink & sound simultaneously giving 2 signals or cues (double cueing)
- Purchase stereos & televisions where the bass can be turned up & the treble down (people lose the ability to hear higher frequency sounds)

**Lighting**

- Use fluorescent lighting to spread light evenly & minimize glare
- Light switches that are easy to reach & can be turned on before you enter the room or lights that come on when you enter the room
- Lighted switch plates
- Well lit stairways with a light switch at the top & one at the bottom
- Use colors that contrast (never use blue & green together)

**37.7.1 WHEELCHAIR THRESHOLD RAMPS**

**Definition:**

**Threshold ramps** act as a door ramp to assist in accessing doorway thresholds as well as small raised floor areas and steps to make entry and/or exit convenient and safe. The threshold ramp sits against the doorsill (inside or outside) to provide a smooth ground to sill transition. They can also be either permanent or portable. Examples 1 thru 6 show the various options for threshold ramps.

Prior to purchasing a threshold ramp, an applicant must ensure that the specifications are **ADA compliant**.

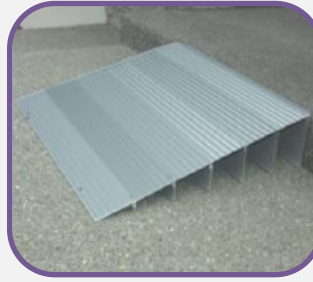

**Example 1**

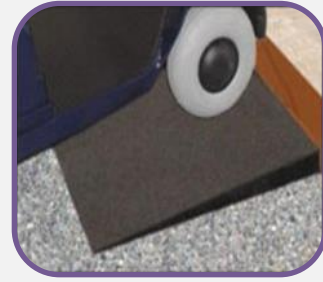

**Example 2**



**Example 3**



**Example 4**



**Example 5**



**Example 6**

*Figure 33.19.1 Detailing other ways to make a residence accessible*





## 38 APPENDIX E: ENERGY AND WATER CONSERVATION ADVISORY DOCUMENT

### E.1 THE PURPOSE OF THE ENERGY AND WATER CONSERVATION ADVISORY DOCUMENT

Energy design, codes and standards set minimum efficiency requirements for new and renovated buildings, assuring reductions in energy use and emissions over the life of the building. Energy efficient buildings are more comfortable and cost-effective to operate, assuring energy, economic and environmental benefits. The overall reduction in energy expenditures also correlates to a mitigated dependency on foreign oil, positively impacting national security. In light of these fundamental environmental issues, economic challenges, and uncertain energy costs, passive energy design as well as mandatory codes are key components of sound public policy, helping to reach the emissions reduction goals of the Bermuda Government Energy White Paper.

#### **E.1.1 ADOPTION OF ENERGY EFFICIENT CODES**

Energy codes are a subset of building codes, which establish baseline requirements and govern building construction. Many states in the US follow both of the following energy conservation codes written by the International Code Council (ICC):

- The International Energy Conservation Code (IECC) for Residential Properties.
- The International Residential Code (IRC)/ Chapter 11 – Energy Efficiency.

Since Bermuda adopted the National Building Code (BOCA) in 1998, which was *‘modified to fit what has over the years become traditional practice in the Bermuda built environment’*, this code follows a similar approach. In the adoption of the International Building Code (IBC), Chapter 32 of this code has incorporated a number of sections from the IECC for residential [To achieve further energy conservation benefits, additional measures can be taken as specified in the IECC].

### **E.2 CLIMATE ZONE**

The IECC climate zone map was developed by DOE researchers at Pacific Northwest National Laboratory (PNNL) with input from Building America team members. The IECC map was developed to provide a simplified, consistent approach to defining climate for implementation of various codes; it was based on widely accepted classifications of world climates that have been applied in a variety of different disciplines. The PNNL-developed map was adopted by the IECC and was first included in the IECC in the 2004 Supplement to the IECC. It first appeared in ASHRAE 90.1 in the 2004 edition.

Moreover, the IECC map divided the United States into eight temperature-oriented climate zones. These zones are further divided into three moisture-oriented regimes designated A, B, and C. Thus the IECC map allows for up to 24 potential climate designations. In 2003, with direction from the Building America teams, researchers at DOE’s National Renewable Energy Laboratory simplified the IECC map for purposes of the Building America Program, into eight climate zones. For reporting purposes, these are further combined into five climate categories: ***Hot-humid, hot-dry/mixed dry, mixed-humid, marine, cold/very cold, and subarctic.***

Bermuda's climate fits into the IECC climate zone designation 2A. Thus in the construction of a residence in Bermuda it is good practice to incorporate the standards laid forth for this specific climate zone.

### **E.3 ENERGY EFFICIENT WINDOWS AND DOORS**

Windows and doors are prominent features of any home. They can also help or hinder a home's energy efficiency. Quality, efficient windows will add cost, but they also provide value in terms of comfort, durability, and energy savings. Lower heating and cooling bills are one benefit of high-performance windows. They may also lower peak loads for heating and cooling a home, which allows for smaller heating, ventilating, and air-conditioning equipment that costs less to purchase and operate. Such savings can eventually recover cost of installing energy-efficient fenestration.

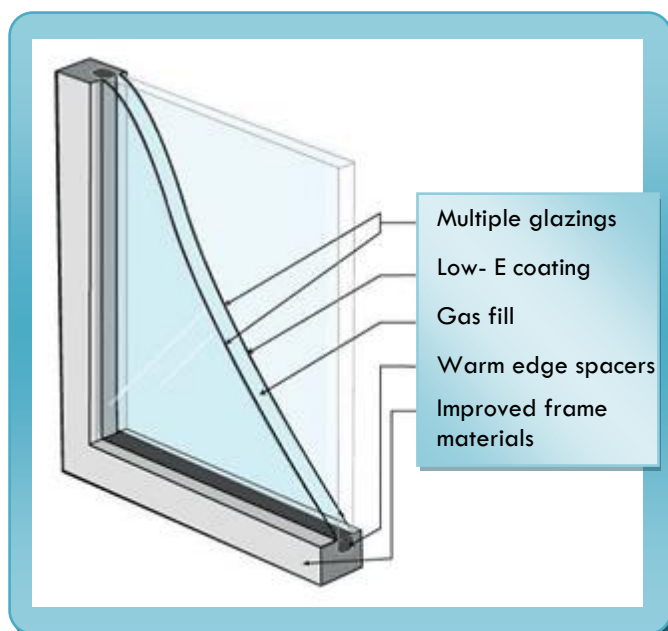

#### **E.3.1 AIRFLOW**

One major source of heat loss through your windows has nothing to do with the type of window you use. Small leaks around the frame, sash, and seal can account for up to 10 percent of your home's energy usage (*U.S. Department of Energy*). Measures to keep heated or cooled air from escaping include caulk and plug of any leak(s). If windows are old, it may be necessary to replace them with newer, tighter-sealing models.

#### **E.3.2 U-FACTOR**

A window's U-factor is the rate at which the glass conducts nonsolar heat. On cold days, your windows may be cool to the touch due

to their having a high U-factor. This type of heat transfer can be reduced by using double- or triple-paned windows; therefore it is pertinent to check the U-factor rating before buying, and buyers should look for windows with a low U-factor. *\*The National Fenestration Rating Council* rates windows on the efficiency of not only the glass and glazing, but also the frames and spacer materials.

#### **E.3.3 SOLAR HEAT GAIN COEFFICIENT (SHGC)**

When the sun shines on your windows, the glass absorbs the radiation and transfers it into your house as heat. Windows with a low solar heat gain coefficient (SHGC) will transmit less heat, keeping your home cooler in hot weather. This specification is particularly important in Bermuda due to our hot summer days.

#### **E.3.4 SURFACE COATING**

Applying low-emissivity, or low-e, coatings to glass surfaces is an additional way of controlling heat transfers. When applied to outside glass panes, these microscopically thin metal or metallic oxide layers keep buildings cooler in the summer by reflecting sunlight. In the winter, low-e coatings on interior panes maintain indoor temperatures by preventing heat from escaping.

**E.3.5 BUYING GUIDE**

When purchasing new windows or doors, look for windows rated by *Energy Star* or the *National Fenestration Rating Council* - they are authentic. These products are guaranteed to help homes save energy, provided the windows are installed correctly. For appropriate specifications for Bermuda’s climate zone, reference the IECC 2012.

**E.3.6 CONSIDERATIONS**

As with any modification to a home, new windows and doors can be costly, so it may be an option to verify if the existing windows can be improved, thus, raising a home's energy efficiency. Various literature sources recommend caulking and weatherstripping any leaks and adding storm windows in winter months to reduce airflow from cold winds. In addition reduced solar heat can be resolved

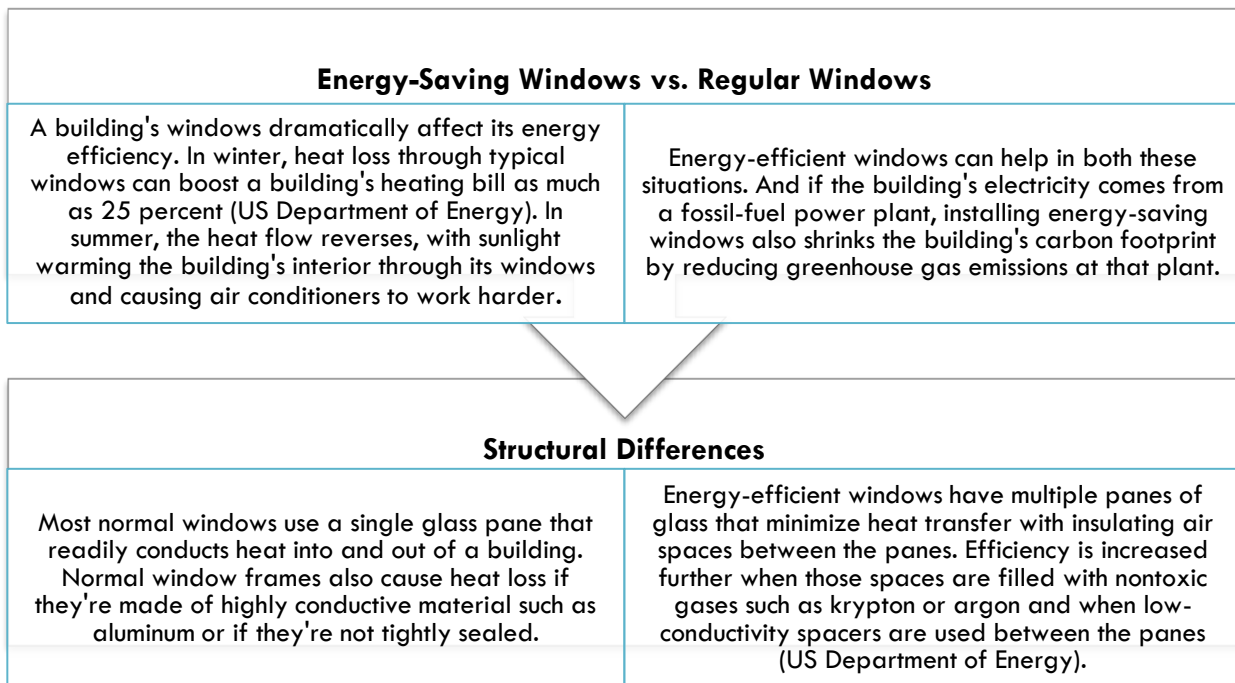

by installing window treatments or curtains.

**E.4 SUN TUBE LIGHTS - SOLAR PIPE LIGHTS**

Sun tube lights are a simple way of transferring natural daylight deep into a building. Natural daylight enters the building through a clear plastic dome and is reflected down a mirrored pipe to illuminate the internal space. Sun tube lights can be used to replace artificial lighting and will, therefore, reduce the annual energy consumption of a house. After the initial purchase cost of the system and its installation, the light delivered is free of charge

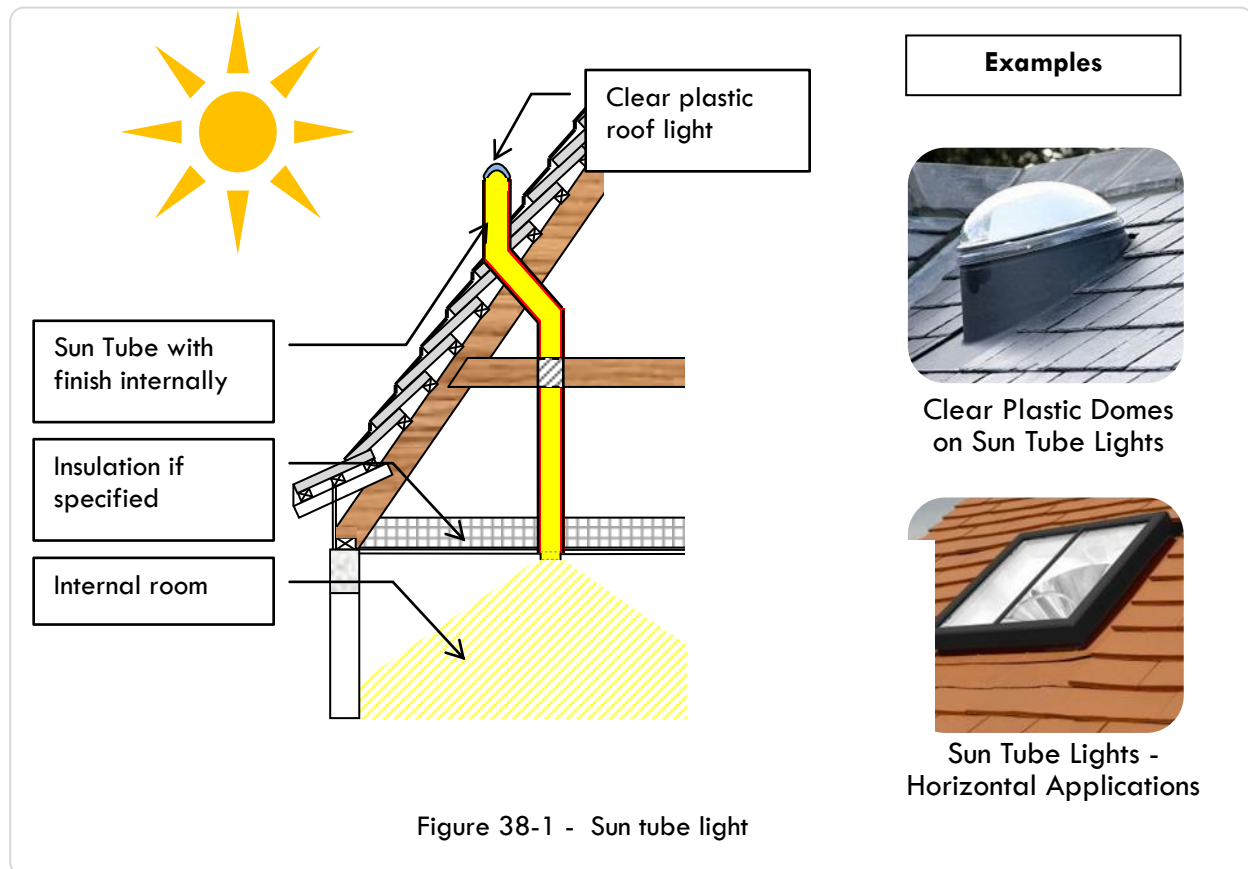
**E.4.1 EFFECTIVE LIGHTING FROM SUN TUBE LIGHTS**

Sources: Low Energy House.Com <http://www.lowenergyhouse.com/sun-tube-lights.html>

Sun tube lights are highly effective at transferring daylight into internal and poorly lit parts of buildings that have little or no natural lighting, particularly bathrooms, stairs, corridors and dark areas. In many cases, sun tube lights will be used to provide all the light for an internal space but they can also be used to complement an artificial lighting scheme. Where possible, the clear plastic dome should be situated on a south facing roof to gain the maximum amount of daylight.

**E.4.2 LIGHT QUALITY FROM SUN TUBE LIGHTS**

Natural daylight is known to give much better quality light than that provided by electric light fittings and is more beneficial to recipients. Even on an overcast day, the quality of light transferred into a house will be considerable when compared with artificial light.

**E 4.3 CLEAR PLASTIC DOMES ON SUN TUBE LIGHTS**

Clear plastic domes are available in unbreakable polycarbonate or impact resistant modified acrylic. They are available in several different sizes depending on the amount of light required and can be located on flat or pitched roofs.

**E 4.4 FITTING A SUN TUBE LIGHTS**

In normal circumstances, sun tube lights require no structural alterations as the tube system fits comfortably between rafters and collar ties. The joints of the tube are sealed using aluminum tape

and only a minimum of fixings are required; often just a single fixing at the bottom of the tube. A system can usually be installed within two to three hours.

#### **E.4.5 SUN TUBE LIGHT ASSEMBLY**

For maximum effectiveness, the sun tube assembly should be as straight as possible. As it is not always possible to mount the clear plastic dome in line with the ceiling diffuser, bends are available to offset the solar tube near the top and bottom. The tube can be swiveled easily, to target natural light exactly where it is required. The offsets bends are adjustable up to 30 degrees from vertical.

#### **E.4.6 INSULATING SUN TUBE LIGHTS**

The outside of the sun tube must be insulated to prevent condensation occurring where it passes through an unheated space, like a loft. It is important that the sun tube's joints and offset bends are also insulated. The insulation must be continuous or heat can be lost and damaging condensation can form.

#### **E.4.7 APPROPRIATE SIZING OF SUN TUBE LIGHTS**

Tubes of approximate diameter:

1. 230mm (10 inches) are suitable for small spaces like shower rooms and toilets;
2. 300mm (12 inches) are suitable for spaces such as kitchens, bathrooms, landings and circulation areas;
3. 450mm (18 inches) and 530mm (21 inches) are suitable for large spaces in larger houses, schools and commercial premises.

#### **E.4.8 DIFFUSERS FOR SUN TUBE LIGHTS**

The sun tube light system uses a mirrored tube that intensifies and reflects natural daylight transferring it to a room or dark area inside. When the light reaches the end of the tube, it can be evenly diffused by a translucent ceiling fixture.

A variety of diffuser designs and sizes are available depending on the light spread required. The sun tube base can also be fitted with a damper so that light can be blocked altogether, when not required.

#### **E.4.9 SUN TUBE LIGHTS - HORIZONTAL APPLICATIONS**

Although mainly used in rooftop applications, clear plastic dome lights can be used for horizontal applications and fixed to an external wall. This configuration is particularly useful for providing daylight into basements. The light can be transferred horizontally at the top of an external wall of a basement. Alternatively, a 90 degree offset can be used to discharge the light through the basement ceiling.

#### **E.4.10 MAINTENANCE OF SUN TUBE LIGHTS**

Because of its shape, the clear plastic dome is self cleaning and it eliminates damaging condensation. The sun tube assembly is sealed and therefore requires no maintenance. Sun tube lights generally have a life expectancy of 35 years.

**E.4.11 PLANNING PERMISSION FOR SUN TUBE LIGHTS**

For small installations, planning permission is unlikely to be required. However, in the case of larger installations or if the property is situated in a Conservation Zone or Area, then it will likely be necessary to seek permission.

**E.5 PASSIVE ENERGY DESIGN**

Energy conservation can and should be considered at the beginning of the design phase. Passive design responds to local climate and site conditions to maximise building users' comfort and health while minimising energy use and affiliated expenses. It achieves this by using free, renewable sources of energy removing the need for mechanical heating or cooling. Using passive design can reduce temperature fluctuations, improve indoor air quality and make a home drier and more enjoyable to live in. It can also reduce energy use and environmental impacts such as greenhouse gas emissions.

**E.5.1 KEY FEATURES OF PASSIVE DESIGN**

The key elements of passive design are:

- Building location and orientation on the site;
- Building layout;
- Window design;
- Insulation (including window insulation);
- Thermal mass;
- Shading; and
- Ventilation.

Each of these elements works with the others to achieve comfortable temperatures and good indoor air quality. The first step is to achieve the right amount of solar access – enough to provide warmth during cooler months but prevent overheating in summer. This is done through a combination of location and orientation, room layout, window design, and shading.

**E.5.2 PASSIVE DESIGN IN NEW AND EXISTING BUILDINGS**

The benefits are greatest when passive design principles are incorporated into the entire design and build process, from site selection onwards. This process is therefore best suited towards new development.

It may be difficult to achieve the full benefits of passive design with existing buildings. For example, it will not be practical to turn a completed house around on the site to take better advantage of sun or cooling breezes. However once a building is completed, some passive design features can be incorporated during later upgrades – for example, such features can be considered when deciding on the location and design for an addition to an existing building.

**E.5.3 ORIENTATION FOR PASSIVE HEATING AND COOLING**

For minimum solar gain in the summer, a building will be located, oriented and designed to minimise window area facing south (or within 20 degrees of south) – for example, a north-south

floor plan. However, this will depend on the site's shape, orientation and topography. For example, a shallow north-south floor plan will not be possible on a narrow east-west site.

#### **E.5.4 SHADING**

Shading should be designed to take into account the sun's path in summer and winter. In Bermuda, the summer sun angle peaks at about 80°, during the summer solstice, and falls to 34° during the winter solstice.

The cooling season typically experiences sun angles of 60° and upwards during peak sun house, therefore buildings should be designed to ensure that all fenestrations facing within 60° of South are shaded from sun angles of 60° or more.

The sun's high angle in summer means that sunshine will not enter these windows during the summer months if fenestration is shaded by eaves or external shades. It is more difficult to shade east and west faces as they receive low morning and afternoon sun. Where low sun is a problem, keep east and west facing glazing to a minimum, or install windows with energy efficient specifications.

The following table recommends shading options for different situations in summer months.

Orientation	Sun direction	Time of day	Type of shading
South	High angle	Middle of day	Fixed or adjustable above window
East-west	Low angle	Morning/evening	Adjustable screens/shutters

Table E.1 – Sun path and measures that control solar heat gain

To design effective shading, it is important to have a good understanding of sun paths at the site at different times of the year.

#### **E.5.5 EXTERNAL SHADING**

External shading on the South side of a residence prevents solar access and therefore helps to keep a building cool in summer months. There are many options for external shade. It's important that each is designed to take account of the sun paths at the site at different times of the year. To be effective, external shading must be considered along with other passive design features such as location, orientation and layout, and window size and placement. Specifically for Bermuda some measures may include (but are not limited to) the following:

- **Screens and shutters:** Fixed and moveable screens and shutters are available in a range of sizes and methods of operation including sliding, hinged and bifolding. The louvre panels may be fixed blade or operable. They provide an excellent solution for low angle morning and evening sun as they can be moved away to admit light when not required.
- **Louvres:** Horizontal, fixed louvres should be angled to the noon mid-winter sun angle and be spaced correctly to admit winter sun.

- **Verandahs:** Verandahs provide excellent shade. Deep verandahs are particularly good for shading east and west facing elevations although they will still admit very low angle sun. They can be used in combination with planting or screens to filter sun.
- **Pergolas:** Pergolas covered with deciduous vines provide very good seasonal shading.
- **Trees and shrubs:** Trees and shrubs provide excellent shading. Adequate planting of native or endemic plants also provides of shelter for inhabitants where *biodiversity* and *natural processes* can benefit.

## **E.6 VENTILATION**

### **E.6.1 PASSIVE VENTILATION**

Passive (naturally occurring) ventilation is when air is exchanged naturally in a building through openings in the building envelope using the stack and wind pressures. Passive ventilation occurs in two different ways:

- ❖ Controlled through openings such as windows and doors;
- ❖ Uncontrolled by infiltration through unintentional openings such as gaps around windows and doors and between building components (undesired).

### **E.6.2 USING PASSIVE VENTILATION FOR COOLING**

In warmer, more humid regions like Bermuda, passive ventilation for cooling should be included in house design. At 50% relative humidity (RH), an air flow of 0.5 m/sec will equate to a 3°C drop in temperature.

#### ***Considerations when designing a home for passive cooling:***

- ❖ Locate, orient and design a form that maximises exposure to cooling breezes.
- ❖ Ensure there are good air flow paths through the building.
- ❖ Specify windows that maximise air flow but minimise unwanted heat gain.
- ❖ Where possible, specify low level (i.e. near the floor) horizontal openings as these are more effective than vertical openings for ventilation purposes.



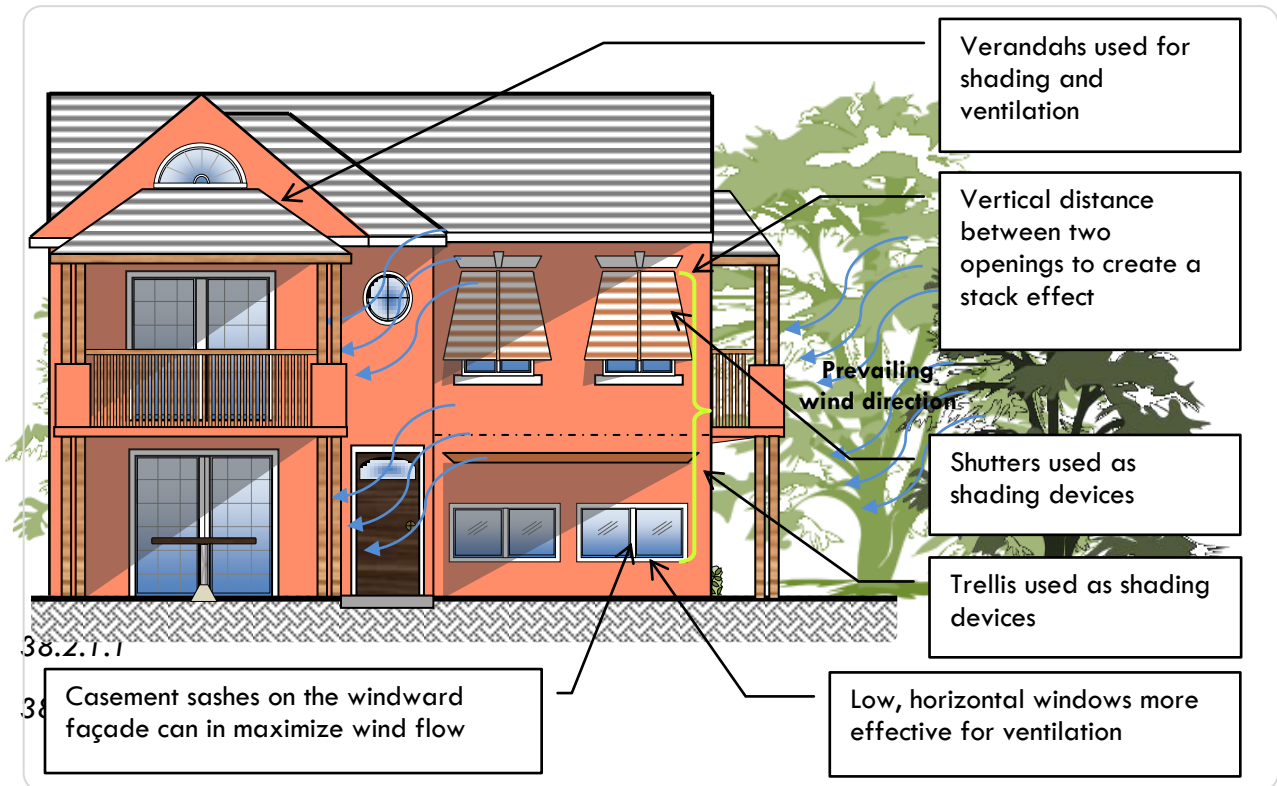

Figure 38-2 - Elevation modified for Bermuda, illustrating passive energy strategies

### E.6.3 FACTORS AFFECTING AIR FLOW RATES

#### *Air flow rates depend on:*

- ❖ prevailing wind direction;
- ❖ average wind speeds (as a guide, use half the average seasonal speed, as wind speeds rarely fall below this value);
- ❖ how the site is influenced by daily and seasonal variations in wind such as onshore/offshore winds and how these may change during the day;
- ❖ building form – whether it enhances or restricts air flow;
- ❖ surrounding landforms and planting – whether they will obstruct air flow or not;
- ❖ orientation and position of windows, doors, roof ventilators, skylights and vent shafts; and
- ❖ surface pressure coefficients around the building.

### E.6.4 CALCULATING AIR FLOW

The air flow rate through a ventilation inlet opening forced by wind can be calculated using the formula below:

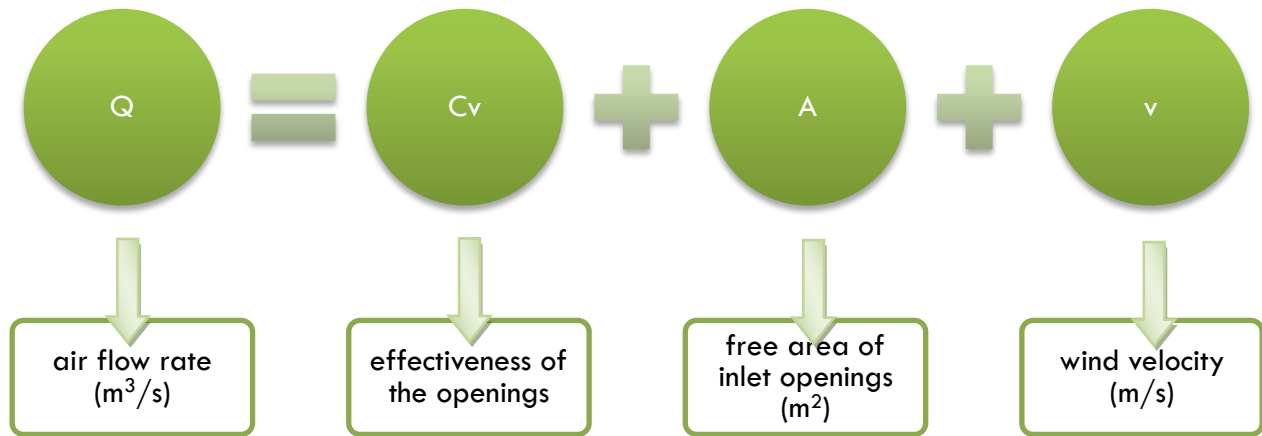

\*  $C_v$  is assumed to be 0.5–0.6 for perpendicular winds and 0.25–0.36 for diagonal winds.

Figure 38-3 - Air Flow Calculation

### E.6.5 VENTILATING FEATURES

When designing a natural ventilation system, the long façade of the building should be facing the prevailing wind direction, with doors and opening windows providing the ventilation openings.

#### Ensure that openings (inlet and outlet) are:

- ❖ not obstructed;
- ❖ the same size;
- ❖ able to control the flow; and
- ❖ located in opposing pressure zones to increase the potential air flow.

Awning windows have a relatively small opening area and are therefore less effective as ventilators.

#### Other ventilating strategies include:

- ❖ maintaining a vertical distance between two openings to create a stack effect, i.e. hot air rising and thereby enhancing air flow;
- ❖ providing shafts to promote air flow;
- ❖ maximising air flow by designing open plan spaces;
- ❖ maximising air flow by having openings at different levels or near the ceiling on opposite sides of the space; and
- ❖ using architectural and landscape features to direct and control air flow - for example, using casement sashes on the windward façade as these can be more efficient than other types of sashes, and
- ❖ including opening windows on the leeward face.

Source: <http://www.environmentdesignguide.net.au/media/TEC02.pdf>.

The illustration below provides a snapshot of some passive energy design elements.

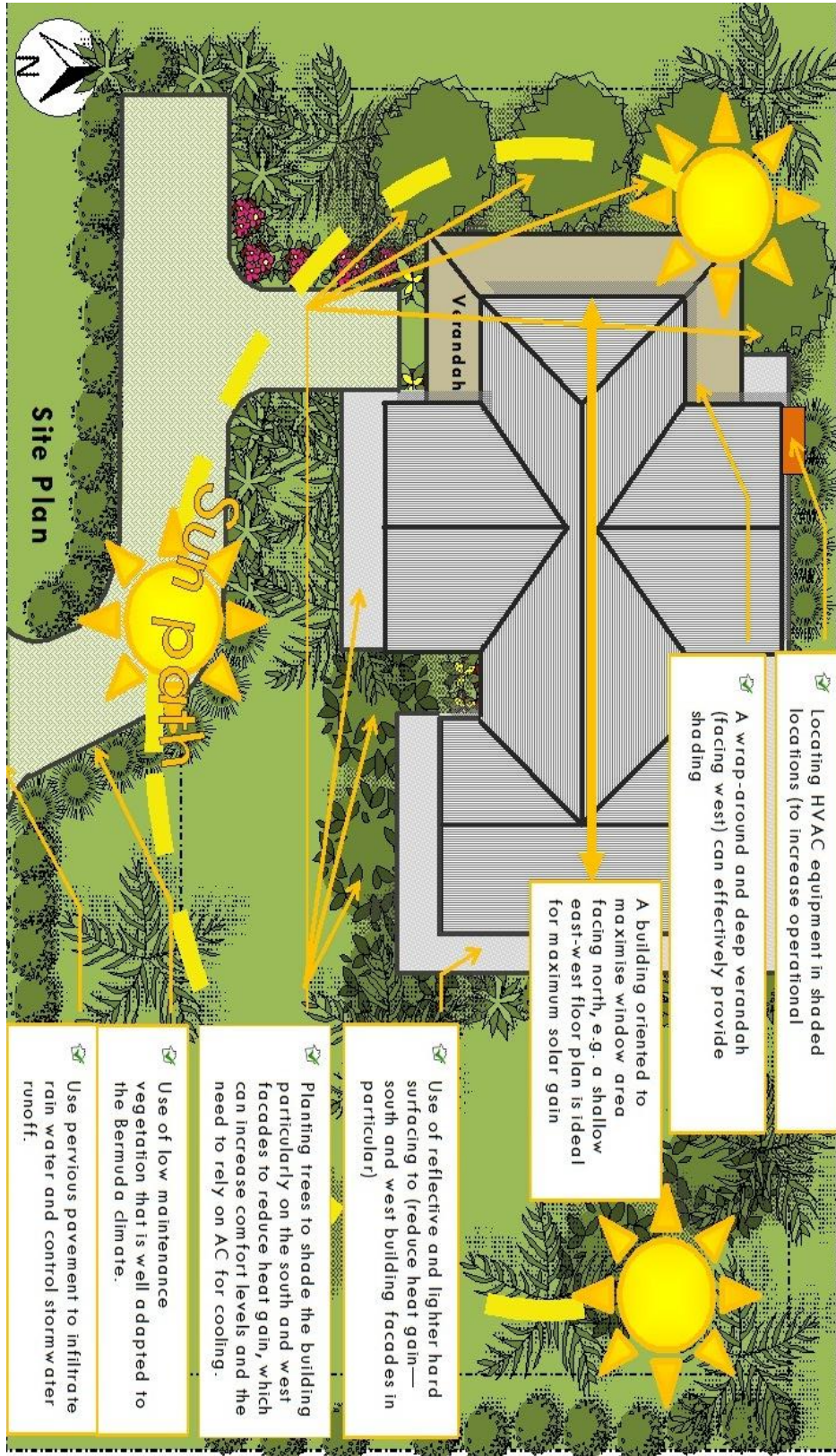

Figure 38-4- Passive Energy Design Examples

## E.7 SOLAR PHOTOVOLTAIC

Solar energy is an infinitely renewable resource that uses the sun's rays to generate electricity for use in your home. By going solar, you can reduce your energy costs and also lower your dependence on fossil fuels, thereby making your own contribution to a cleaner environment.

### E.7.1 THE BASICS

A residential solar-energy system uses solar modules, made up of photovoltaic (PV) cells, to harvest the sun's energy in 'direct current' form. This energy is then converted to grid-compatible "Alternating Current" by an Inverter. Once converted, the electricity can be used to power household appliances.

### E.7.2 GRID-CONNECTED SYSTEMS

Small solar electric energy systems connected to the local utility's electricity distribution system and are called grid-connected systems. A grid-connected solar electric system can reduce consumption of utility-supplied electricity for lighting, appliances and other uses. If the solar electric system cannot deliver the full amount of energy needed, the utility makes up the difference. When the solar electric system produces more electricity than the household requires, the excess is sent or sold to the utility also known as Net Metering.

### E.7.3 WHAT IS NET METERING?

A net metering program allows the electric meters of customers with generating facilities to turn backwards—and send electricity back into the grid—when a customer's generator produces more energy than is used. Ordinarily, when a homeowner uses electricity from the grid their meter spins forward. The less electricity used from the grid, the slower the meter spins. In some cases—with net metering—when a homeowner is feeding electricity back to the grid, their meter spins backwards. Net metering allows customers to offset their electricity consumption over the entire billing period, not just instantaneously. This offset enables customers with generating facilities to receive payment from the utility for the excess electricity they generate and export to the grid.

Figure 38-5- Solar PV Illustration

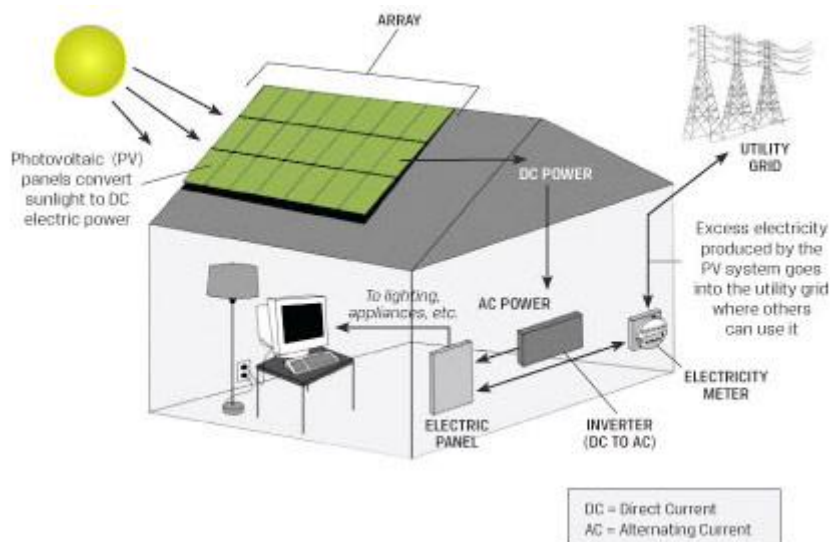

**E.7.4 BASIC PARTS OF A SMALL SOLAR ELECTRIC SYSTEM**

Home solar electric systems are generally comprised of a collector or collectors, wiring, controllers, inverters and/or batteries and mounting brackets to optimize the panels' exposure. The solar electric panels need to be solidly mounted. Mounting racks must be engineered and installed to withstand the element of wind. Panels can be mounted on the roof of a home, garage or shed or standalone either on the ground or a pole.

Mounting solar electric systems on rooftops is one option, providing safe and easy access for adjusting and servicing panels. Stationary mounted panels can also be adjustable, permitting solar electric panels to face the sun as near to perpendicular as possible. The sun is much higher in the sky in the summer and lower in the winter. Solar panels mounted to the same angle as Bermuda's latitude will produce the optimal annual electricity production without having to adjust the angle. Solar electric panels may also be mounted on a tracking system, which will automatically adjust so that the PV panels face the sun throughout the day. Tracking systems can improve solar electric output by up to 30 percent.

For a residential grid-connected application, the balance of system parts may include a controller, storage batteries (if back-up power is desired), a power conditioning unit (inverter), and wiring. It is critical that all components be approved by a recognized testing agency, like Underwriters Laboratories (UL), to assure the components meet safety standards.

**E.7.5 INSTALLATION AND MAINTENANCE**

Many dealers also offer installation and maintenance services. Those interested in installing a solar PV system should ensure they use a reputable installer. Good resources to find information about reputable dealers are the phonebook, the utility, the Internet, and the Department of Energy. A credible installer will provide many services such as obtaining necessary permits. As a general rule the Department of Energy recommends installation by a trained licensed electrical contractor or licensed electrical professional.

**E.7.6 SAFETY/ ELECTRICAL REQUIREMENTS**

Electrical code requirements are based on the current National Electrical Code (NEC), which is published by the National Fire Protection Association. Solar electric energy installations are governed by the NEC.

**E.7.7 SOLAR PANEL DETAIL USING TRADITIONAL CONSTRUCTION PRACTICES**

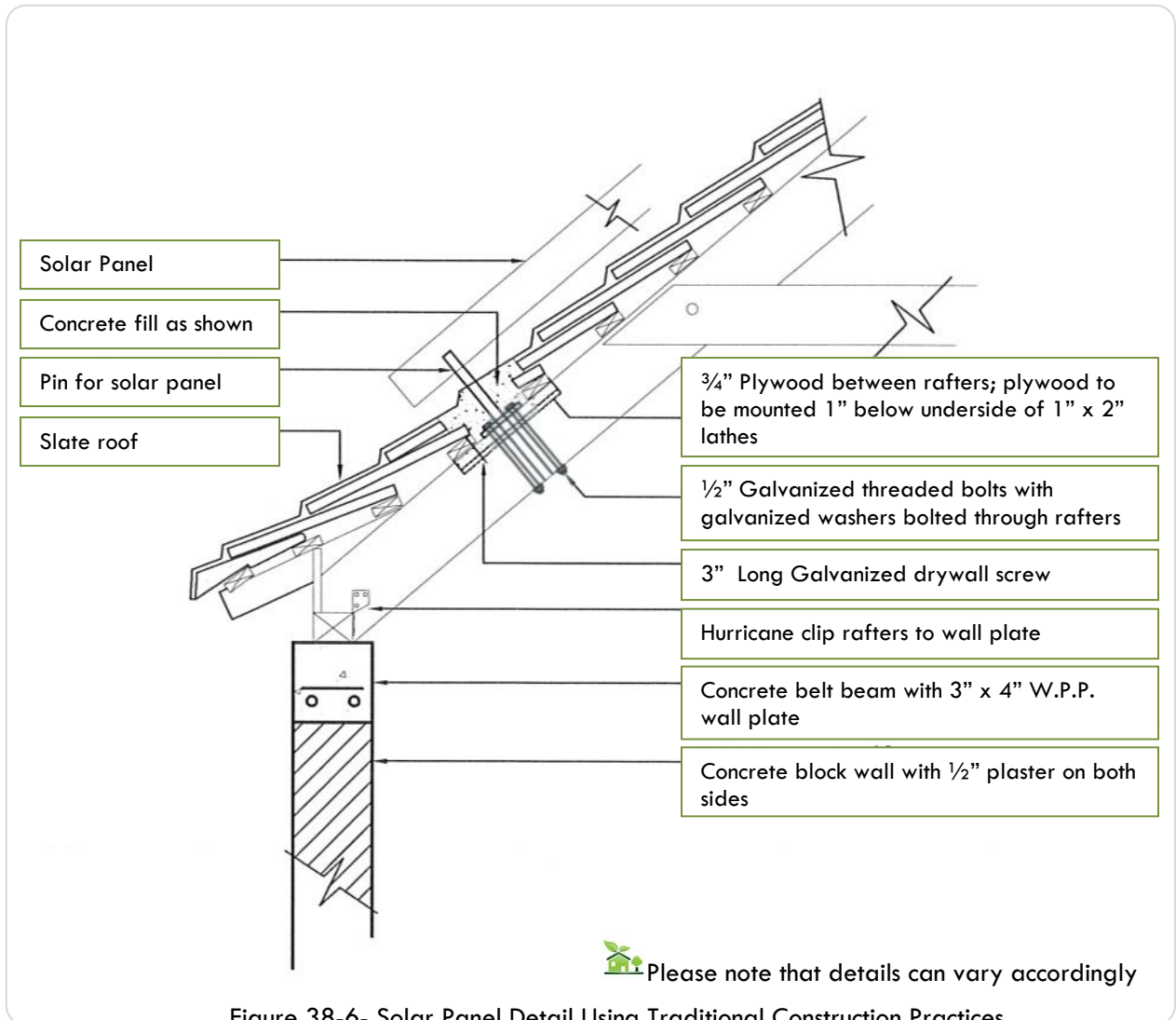

Figure 38-6- Solar Panel Detail Using Traditional Construction Practices

## **E.8 SOLAR WATER HEATERS**

### **E.8.1 HOW SOLAR WATER HEATING WORKS**

A solar water heating system is a simple and reliable energy source for your home. Solar water heaters come in a wide variety of designs, all including a collector and storage tank, and all using the sun's thermal energy to heat water. Solar water heaters are typically described according to the type of collector and the circulation system. There are two types of solar water heating systems: active, which have circulating pumps and controls, and passive, which do not.

### **E.8.2 ACTIVE SOLAR WATER HEATING SYSTEMS**

There are two types of active solar water heating systems:

#### **1. Direct circulation systems**

Pumps circulate household water through the collectors and into the home.

#### **2. Indirect circulation systems**

Pumps circulate a non-freezing, heat-transfer fluid through the collectors and a heat exchanger. This heats the water that then flows into the home. They are popular in climates prone to freezing temperatures.

### **E.8.3 PASSIVE SOLAR WATER HEATING SYSTEMS**

Passive solar water heating systems are typically less expensive than active systems, but are usually not as efficient. However, passive systems can be more reliable and may last longer. There are two basic types of passive systems:

#### **1. Integral collector-storage passive systems**

This system works best in areas where temperatures rarely fall below freezing. They also work well in households with significant daytime and evening hot-water needs.

#### **2. Thermosyphon systems**

Water flows through the system when warm water rises as cooler water sinks. The collector must be installed below the storage tank so that warm water will rise into the tank. These systems are reliable, but contractors must pay careful attention to the roof design because of the heavy storage tank. They are usually more expensive than integral collector-storage passive systems.

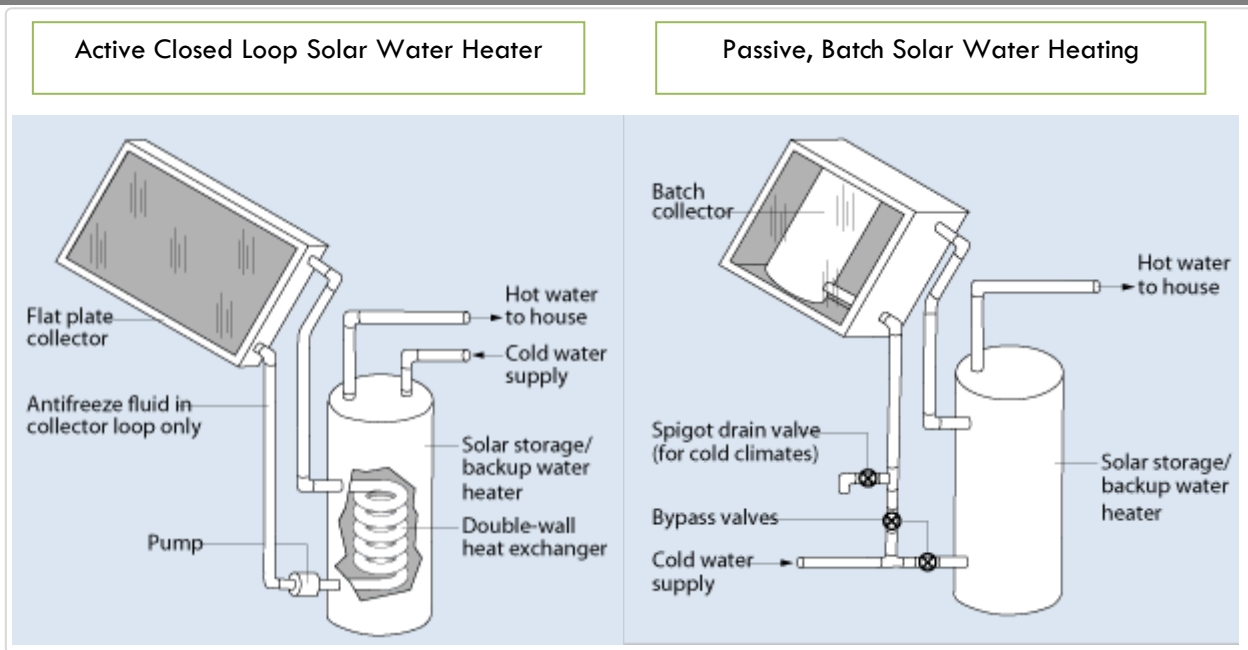

Figure 38-7- Passive, Batch Solar Water Heating

Source: <http://energy.gov/energysaver/articles/solar-water-heaters>

#### E.8.4 STORAGE TANKS AND SOLAR COLLECTORS

Most solar water heaters require a well-insulated storage tank. Solar storage tanks have an additional outlet and inlet connected to and from the collector. In two-tank systems, the solar water heater preheats water before it enters the conventional water heater. In one-tank systems, the back-up heater is combined with the solar storage in one tank.

There are three types of solar collectors used for residential applications:

##### Flat-plate collector



Glazed flat-plate collectors are insulated, weatherproofed boxes that contain a dark absorber plate under one or more glass or plastic (polymer) covers. Unglazed flat-plate collectors -- typically used for solar pool heating -- have a dark absorber plate, made of metal or polymer, without a cover or enclosure. Flat plate collectors are typically sized to contain 40 gallons of water.

##### Integral collector-storage systems



Also known as ICS or *batch* systems, these feature one or more black tanks or tubes in an insulated, glazed box. Cold water first passes through the solar collector, which preheats the water. The water then continues on to the conventional backup water heater, providing a reliable source of hot water. They should be installed only in mild-freeze climates because the outdoor pipes could freeze in severe, cold weather.



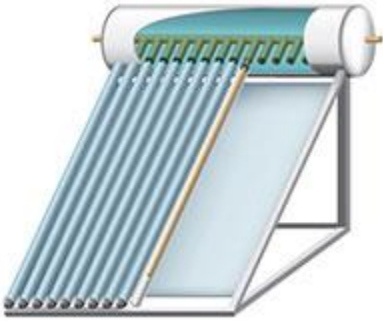

### **Evacuated-tube solar collectors**

These collectors feature parallel rows of transparent glass tubes. Each tube contains a glass outer tube and metal absorber tube attached to a fin. The fin's coating absorbs solar energy but inhibits radiative heat loss. These collectors are used more frequently for U.S. commercial applications.

## **E.8.5 SELECTING A SOLAR WATER HEATER**

Before you purchase and install a solar water heating system, it is advisable to do the following:

1. Estimate the cost and energy efficiency of a solar water heating system
2. Evaluate your site's available solar resources
3. Determine the correct system size
4. Investigate planning and building regulations.

## **E.8.6 SOLAR PANEL DETAIL USING TRADITIONAL CONSTRUCTION PRACTICES**

See detail in Figure 38-6.

## **E.9 SUSTAINABLE DRAINAGE SYSTEMS OR PERVIOUS SURFACES**

### **E.9.1 WHAT ARE SUSTAINABLE DRAINAGE SYSTEMS (SUDS) OR PERMEABLE PAVEMENT?**

Sustainable drainage systems (SUDS) are a natural approach to managing drainage in and around properties and other developments. It is best suited to deal with run-off at or close to the surface where rainfall lands. SUDS work by slowing and holding back the water that runs off from a site, allowing natural processes to break down pollutants.

This can be achieved by using permeable (porous) paving to capture stormwater from rainfall allowing it to percolate and seep into the ground, to an underlying reservoir base where the water is either naturally filtered to underlying soils or removed by a subsurface drain (see diagram above). By trapping suspended solids and filtering pollutants from the water, it enables surrounding vegetation to benefit and also diminishes flooding in certain areas.

Standard asphalt and concrete pavement are considered to be “impermeable.” Precipitation that falls on or drains to them cannot flow through the surface to the soils below, but runs to the lowest points to be drained away creating the potential for flooding.

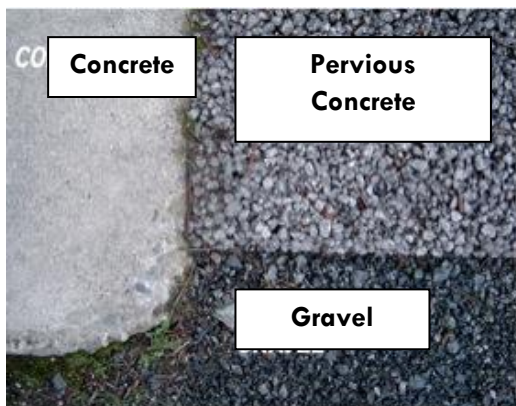
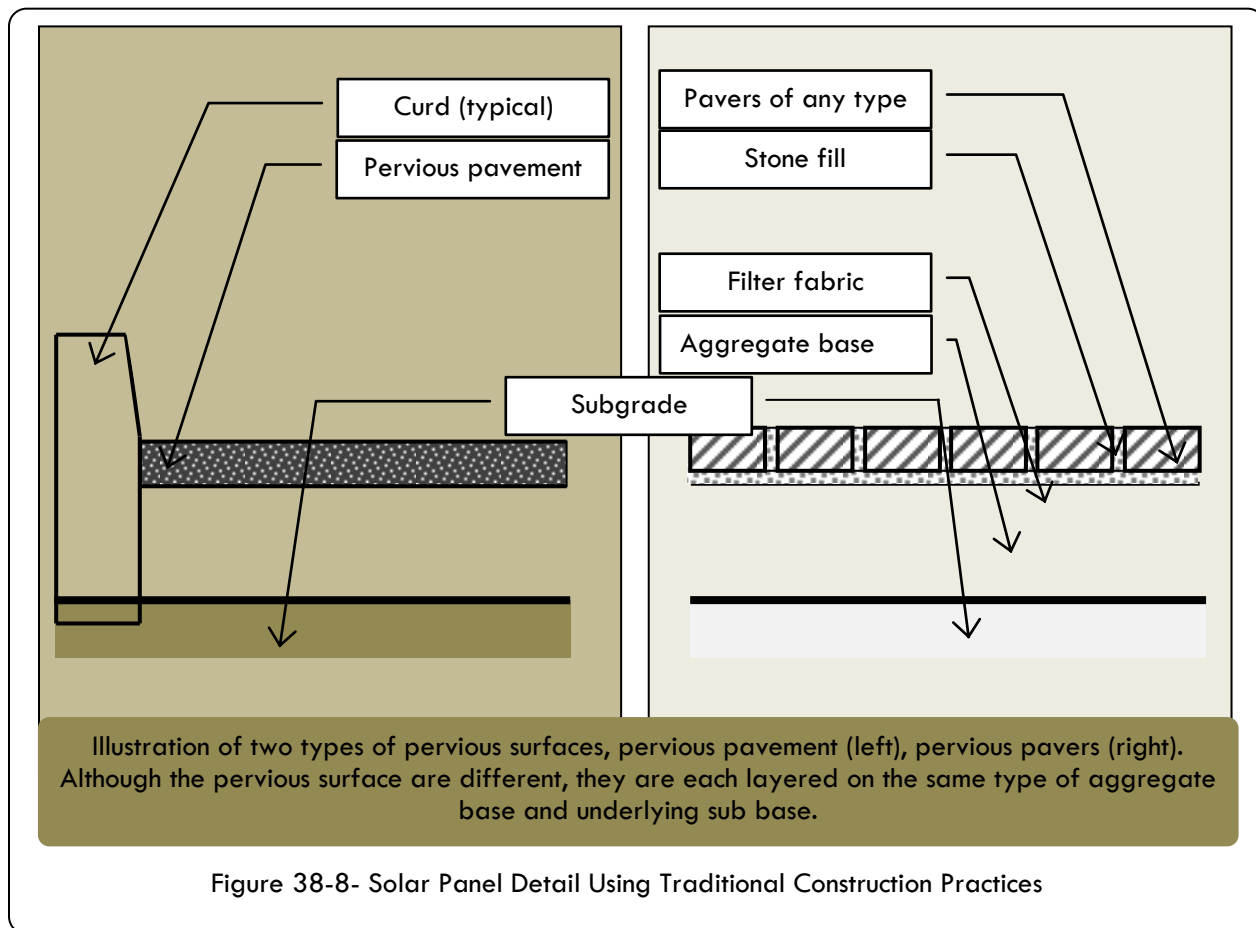

Permeable pavement can be used instead of standard asphalt and concrete for roads, paths, lawns, residential [sidewalks](#) and driveways and lots that are subject to light vehicular traffic, such as car/[parking lots](#), [cycle-paths](#), service or emergency access lanes.

Permeable asphalt and concrete do not look markedly different from their less pervious counterparts, but a close inspection can reveal larger surface “pores.” Permeable unit pavers and grid systems are usually easier to distinguish from a distance.

**E.9.2 HOW PERMEABLE PAVEMENT WORKS?**

**E.9.2.1 QUANTITY**

The amount of water stored depends on the voids ratio of the permeable fill or sub-base, the plan area and depth. Water can be disposed of by infiltration, an underdrain, or pumped out for harvesting or discharge. Overflow can be via a high level drain or controlled surface flow. In some situations the water should not be stored for extended periods as it can affect the strength of the surrounding soil.

**E.9.2.2 QUALITY**

The permeable fill or sub-base traps sediment, thereby cleaning up runoff. Recent research shows that they also provide some treatment for other pollutants, such as oil.

**E.9.2.3 AMENITY**

The variety of surfaces is wide enough for the landscape architect to select a hard landscape style to suit the style of the development. By their nature, filter drains and permeable surfaces ensure an efficient use of space, providing options for multiple uses.

**E.9.3 DESIGN CONSIDERATIONS**

Permeable surfaces are appropriate for both residential and commercial land uses, new construction and retrofit projects. They are typically not as strong as traditional cement or asphalt pavements, so their use should be restricted to low traffic areas.

**MATERIALS**

There are various types of pervious pavement available and include:

- ❖ **Poured-in-place pervious asphalt** requires the same mixing and application materials and the same 'blacktop' appearance of traditional impervious asphalt. The formula is different with small stone and fine particulate matter being removed and the quantity of tar reduced. Sealants to waterproof new surfaces are not applied.
- ❖ **Poured-in-place pervious concrete** surfaces like pervious asphalt require similar machinery to standard concrete pavement. Permeability is accomplished by using larger pea gravel with lower water-to-cement ratio creating a pebbly surface that is compacted with a roller.
- ❖ **Block and concrete modular pavers** are designed to funnel water between blocks into a basement layer of washed sand and gravel where water slowly drains away through the soil. The open areas in the paving system provide 20-50% more opportunity for the drainage of water than in the normal paved system. Pavers are best used for driveways, parking areas, shoulders along airstrips and highways, roadway medians, boat launching ramps, emergency access roads, fire lanes, sidewalks, grassed rooftops, pool decks and patios.
- ❖ **Grid pavers** made from either recycled plastic or concrete. The grid pattern is usually honeycombed or lattice shaped and the voids collect water during rain events, which then slowly drains into the soil below.
  - The grid pattern is filled with gravel and/or grass to create a visually appealing appearance. If grass is desirable, better growing conditions are best encouraged by the addition of soil to the subbase sand and gravel mix.
  - The grid's physical structure provides support for vehicular use and helps prevent erosion.
  - The flexibility of plastic type grid pavers allows their use at sites with an uneven topography.

- Grid pavers are ideal for natural landscape projects involving gardens or recreational areas that support both vehicular and pedestrian traffic. These include sidewalks, parking areas, golf cart paths, residential driveways, fire lanes and emergency access roads.

### **E.9.3.1 SITING**

- ❖ Pervious pavement should be limited to low traffic areas.
- ❖ Soil infiltration rate should be tested. A minimum rate of 0.27 inches per hour is required and a rate of 0.5 inches per hour is preferred.
- ❖ Other design features to be considered include a site slope of less than 5", an area with underlying sandy soil and a low water table (i.e., seasonally high 24" or more beneath the paver base)
  - *As a rule of thumb if septic tanks are used in a region the soil will allow sufficient water percolation for instillation of pervious pavement.*
  - Pervious pavements to be installed in low permeability (clay) soils require the base materials to act as temporary storage for storm events and subsequent drainage through the soil. The base should be composed of clean washed stone with 25-35%voids. Capacity of the base material storage should be incorporated into design criteria and related to the desired performance of the system during storm events. Typically design should accommodate runoff for the 6 month-24 hour duration storm event.
  - The system should fully drain after a storm event within a minimum of 12 hours, and a maximum of 72 hours (the recommended time is 24 hours).
  - The pavement can be designed to provide percolation rates from 5.6 – 18.5 gallons per minute per square foot.
- ❖ Pervious pavement sites should not be located:
  - Within four feet above bedrock or a water table's high point.
  - Within 100 feet of a well.
  - Within 10 feet of building foundation that is above proposed pavement location or 100 feet from a building foundation that is below the proposed pavement location.
  - Within close proximity of sources of contaminants e.g. gas stations.
  - On slopes that exceed five percent, the flatter the surface the better.

### **E.9.3.2 CONSTRUCTION**

- ❖ To ensure success it is critical to pay special attention and follow engineering design for substrate base and hydraulic design for entire project. Geotechnical testing should be conducted prior project start, to determine site conditions (see Siting above) and derive engineering design plan.
- ❖ Excavation and grading need to be accomplished with light equipment to prevent soil compaction.

- ❖ Be sure to protect planned pavement area from storm water runoff before and during construction by diverting stormwater runoff. Stormwater events during construction will contaminate cleaned and washed basement materials by adding sediments that will fill the void spaces designed to store water from storm events thereby compromising desired pervious function of pavement. If site stormwater protection is compromised all base materials need to removed and again washed clean
- ❖ Basement layers and pavement can be laid, closely following given engineering design criteria. A typical cross section of layers involved in developing pervious pavement include:
  - Pavement –three quarters (asphalt) to four inches thick (pavers)
  - Filter Course - two inches thick made of half-inch crushed stone
  - Reservoir Course - thickness based on runoff storage required and is made with one and a half to three inch diameter stone
  - Filter fabric
  - Existing soil managed to have minimal compaction to retain soil porosity

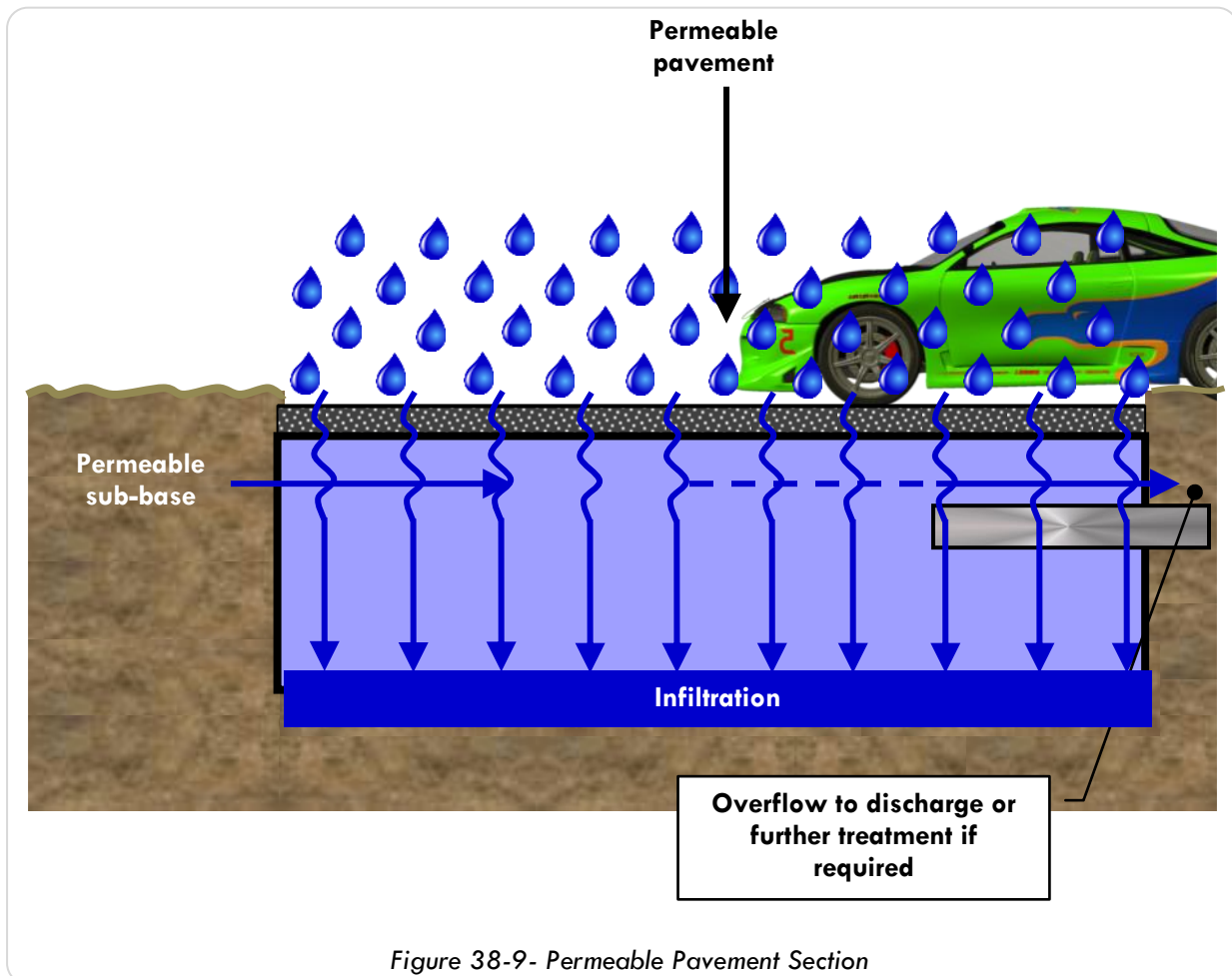

Figure 38-9- Permeable Pavement Section

- ❖ Engineering requirements for pervious pavement are similar to laying regular pavement and include:
  - Pavement with sufficient thickness to protect subgrade materials from being overstressed
  - Use quality subgrade materials that can support expected loads
  - Placement on a stable surface
  - Compaction of materials to provide strength.

#### **E. 9.4 MAINTENANCE**

Over time, larger particles will trap smaller and smaller particles reducing the infiltration rate and cause clogging resulting in ponding and surface runoff. Therefore periodic maintenance is required that consists of vacuum sweeping at least four times a year followed by high-pressure hosing to free pores in the top layer from clogging.

#### **E.9.5 PLANNING PERMISSION FOR PERMEABLE PAVEMENTS**

For small installations, planning permission is unlikely to be required. However, in the case of larger installations or if the property is situated in a Conservation Zone or Area, then, it is strongly recommended to seek permission or at the very least a pre-consultation with the Department.

#### **E.9.6 BUILDING PERMIT/REGULATIONS**

All applications for permeable pavement will have to be furnished with the specifications and installation requirements from the manufacturer of choice. Such applications can possibly be considered and reviewed as minor development applications, otherwise known as a Permitted Development Permit (PDP) or a full Building Permit application which will be subject to affiliated site factors, such as square footage, location and the type of pavement used, etc (see section 6.4).

#### **E.9.7 CERTIFICATE OF INSTALLATION**

A certificate of installation in accordance to the manufacturer's specifications must be furnished at the time of completion by a certified installer.

#### **E.9.8 OTHER TYPES OF POROUS PAVEMENTS**

**1. Porous turf**, if properly constructed, can be used for occasional parking like that at churches and stadia. Plastic turf reinforcing grids can be used to support the increased load. Living turf transpires water, actively counteracting the "heat island" with what appears to be a green open lawn.

**2. Permeable interlocking concrete pavements** are concrete (or stone) units with open, permeable spaces between the units. They give an architectural appearance, and can bear both light and heavy traffic, particularly interlocking concrete pavers, excepting high-volume or high-speed roads. Some products are polymer-coated and entirely porous face.

**3. Permeable clay brick pavements** are fired clay brick units with open, permeable spaces between the units. Clay pavers provide a durable surface that allows stormwater runoff to permeate through the joints.

**4. Resin bound paving** is a mixture of resin binder and aggregate. Clear resin is used to fully coat each aggregate particle before laying. Enough resin is used to allow each aggregate particle to adhere to one another and to the base yet leave voids for water to permeate through. Resin bound paving provides a strong and durable surface that is suitable for pedestrian and vehicular traffic in applications such as pathways, driveways, car parks and access roads.

**5. Elastomerically bound recycled glass porous pavement** consisting of bonding processed post consumer glass with a mixture of resins, pigments, and binding agents. The product trademarked as FilterPave provides a permeable paving material that also reuses materials that would otherwise be disposed in landfills. Approximately 75 percent of glass in the U.S. is disposed in landfill.

**6. Gravel Pavers** are similar to grass pavers except that the growing medium is replaced with gravel and no plant materials are used. The look is similar to a simple gravel parking lot but the grid system helps keep gravel pieces in place over time, preventing ruts and worn spots.



**1. Porous asphalt**



**2. Porous Turf**



**3. Permeable interlocking concrete pavements**



**4. Permeable clay brick pavements**



**5. Resin Bound Paving**

*Figure 38-10- Visual examples of Permeable Paving*



## 39 APPENDIX F: CONTACT INFORMATION FOR GOVERNMENT DEPARTMENTS

<b>Department of Planning</b>	Dame Lois Browne-Evans Building 5 <sup>th</sup> Floor, 38 Court Street, Hamilton, HM12, Bermuda	General Enquiries	297-7756
		Building Control Enquiries	297-7756
		Building and Electrical inspection requests	297-7828 (Code-a-phone)
		Enforcement	297-7634
		Fax	295-4100
<b>Department of Health</b>	6 Hermitage Rd, Devonshire, FL01	General Enquiries	278-5333
		Fax	232-1941
		Plumbing Inspections	278-5338
<b>Department of Health &amp; Safety</b>	6 Hermitage Rd, Devonshire, FL01	General Enquiries	278-5333
		Fax	232-1941
<b>Water Authority</b>	Botanical Gardens, 169 South Rd, Paget, DV04	General Enquiries	236-4201
<b>National Office for Seniors and the Physically Challenged</b>	60 Stonehall, Victoria Street, Hamilton, HM12	General Enquiries	292-7802



## 40 REFERENCES

- Department of Justice (2010): *2010 ADA Standards for Accessible Design*, Americans with Disabilities Act, United States
- Department of Planning (2008): *The Bermuda Plan*, Ministry of Home Affairs, Bermuda Government, Bermuda
- Department of Sustainable Development (2008): *Charting Our Course: Sustaining Bermuda*. Bermuda
- International Code Council (2003): *2003 International Building Code*, ICC, INC
- The Ministry of Health (1999): *Residential Care Homes and Nursing Act 1999, Residential Care Homes and Nursing Homes Regulations 2001*, Bermuda Government, Bermuda
- Office of the Deputy Prime Minister (2005): *Planning Policy Statement 1 - Delivering Sustainable Development*. ODPM, London
- Department of Energy (2011): *2011 Bermuda Energy White Paper: A National Energy Transition*, Department of Energy, Ministry of Economic Development, Bermuda
- International Code Council (2009): *"International Energy Conservation Code"*, ICC, United States
- US Department of Energy, Energy Efficiency and Renewable Energy – Buildings Technology Program (2010): *"High Performance Home Technologies: Guide to Determine Climate Regions by Country"*, Pacific Northwest National Laboratory & Oak Ridge National Laboratory, United States

### Websites

- [http://www.adaptiveaccess.com/home\\_changes.php](http://www.adaptiveaccess.com/home_changes.php) - accessed 18 Nov. 11
- RLGA Technical Services LLC - [www.specsandcodes.com](http://www.specsandcodes.com) – accessed 10 Jan. 12
- <http://www.lakesuperiorstreams.org/stormwater/toolkit/paving.html>
- <http://energy.gov/energysaver/articles/solar-water-heaters>
- [http://www.energystar.gov/index.cfm?c=solar\\_wheat.pr\\_how\\_it\\_works](http://www.energystar.gov/index.cfm?c=solar_wheat.pr_how_it_works)
- [www.candwarch.co.uk/.../zero-carbon-homes.shtml](http://www.candwarch.co.uk/.../zero-carbon-homes.shtml) - accessed 18 Jan. 12
- <http://www.wisehomedesign.com/building-an-energy-efficient-house.html> - accessed 20 Mar. 12
- <http://www.wisehomedesign.com/building-an-energy-efficient-house.html> - accessed 9 May. 12
- [http://www.greenerchoices.org/pdf/Energy\\_Codes-Advocates.pdf](http://www.greenerchoices.org/pdf/Energy_Codes-Advocates.pdf). - accessed 9 June. 12
- <http://www.dos.ny.gov/DCEA/pools.htm>
- <http://energycenter.org/uploads/Residential%20Efficiency%20Measures.pdf>
- <http://www.energy.ca.gov/reports/300-98-012.PDF>
- <http://greenliving.nationalgeographic.com/energyefficient-residential-windows-2646.html>